

Courses

ACC (1) AFCAT (1) AIRMEN (2) CAPF (1) CDS EXAM (2) INET OFFICER (1) MNS (1) MOCK TEST (3) NDA EXAM (1) PC(SL) (1) SCO (1) SSB INTERVIEW (1) TERRITORIAL ARMY (1)

<p>HIGHEST RATED</p>  <p>617 PEOPLE ONLINE NOW</p> <p>CDS Exam Online Course 2021 – 2022</p> <p>★★★★★ 5 (80)</p> <p>₹ 4,999.00</p>	<p>BEST SELLER</p>  <p>997 PEOPLE ONLINE NOW</p> <p>CDS OTA Exam Online Course 2021 – 2022</p> <p>★★★★★ 5 (77)</p> <p>₹ 4,499.00</p>	<p>BEST SELLER</p>  <p>206 PEOPLE ONLINE NOW</p> <p>AFCAT Exam Online Course 2022</p> <p>★★★★★ 5 (64)</p> <p>₹ 4,999.00</p>	<p>HIGHEST RATED</p>  <p>561 PEOPLE ONLINE NOW</p> <p>NDA Exam Online Course 2021 – 2022</p> <p>★★★★★ 5 (72)</p> <p>₹ 4,999.00</p>	<p>HOT & NEW</p>  <p>740 PEOPLE ONLINE NOW</p> <p>Territorial Army Exam Online Course 2021 – 2022</p> <p>★★★★★ 5 (53)</p> <p>₹ 4,999.00</p>	<p>HOT & NEW</p>  <p>995 PEOPLE ONLINE NOW</p> <p>ACC Exam Online Course Army Cadet College 2021 – 2022</p> <p>★★★★★ 5 (53)</p> <p>₹ 6,999.00</p>
<p>HOT & NEW</p>  <p>90 PEOPLE ONLINE NOW</p> <p>OIR Test and PPDT Online Course – Officers Intelligence Rating Test</p> <p>★★★★★ 5 (50)</p> <p>₹ 2,999.00</p>	<p>BEST SELLER</p>  <p>98 PEOPLE ONLINE NOW</p> <p>MNS Military Nursing Service Exam Online Course 2022</p> <p>★★★★★ 5 (44)</p> <p>₹ 4,999.00</p>	<p>HOT & NEW</p>  <p>37 PEOPLE ONLINE NOW</p> <p>AFCAT Exam Online Mock Test Series</p> <p>★★★★★ 5 (65)</p> <p>₹ 299.00</p>	<p>BEST SELLER</p>  <p>36 PEOPLE ONLINE NOW</p> <p>CDS Exam Online Mock Test Series</p> <p>★★★★★ 5 (79)</p> <p>₹ 299.00</p>	<p>BEST SELLER</p>  <p>18 PEOPLE ONLINE NOW</p> <p>NDA Exam Online Mock Test Series</p> <p>★★★★★ 5 (72)</p> <p>₹ 299.00</p>	<p>HOT & NEW</p>  <p>37 PEOPLE ONLINE NOW</p> <p>UPSC CAPF Assistant Commandant Online Course 2022</p> <p>★★★★★ 5 (46)</p> <p>₹ 4,999.00</p>





AFCAT 2 2022

COMPLETE

REASONING

PART 2

LIVE  CLASS

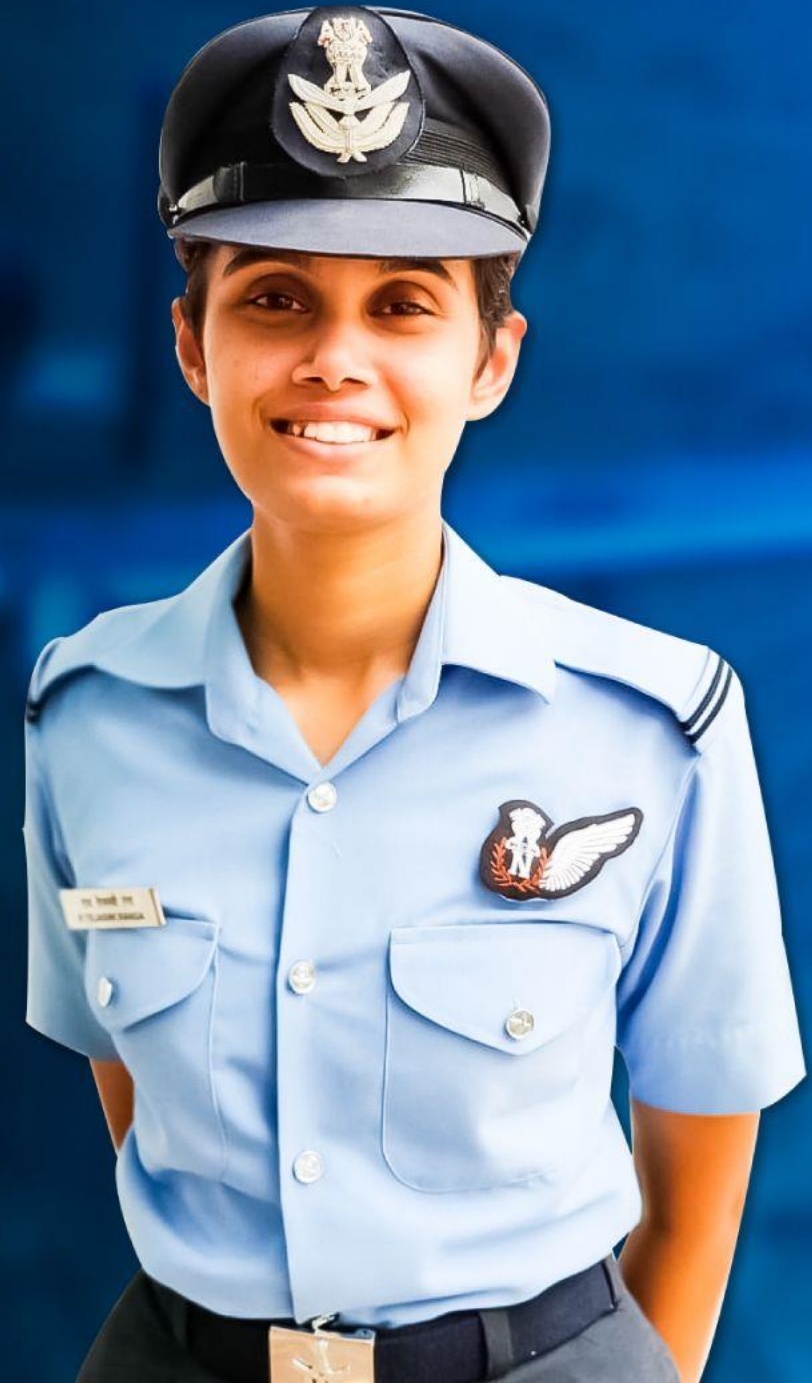

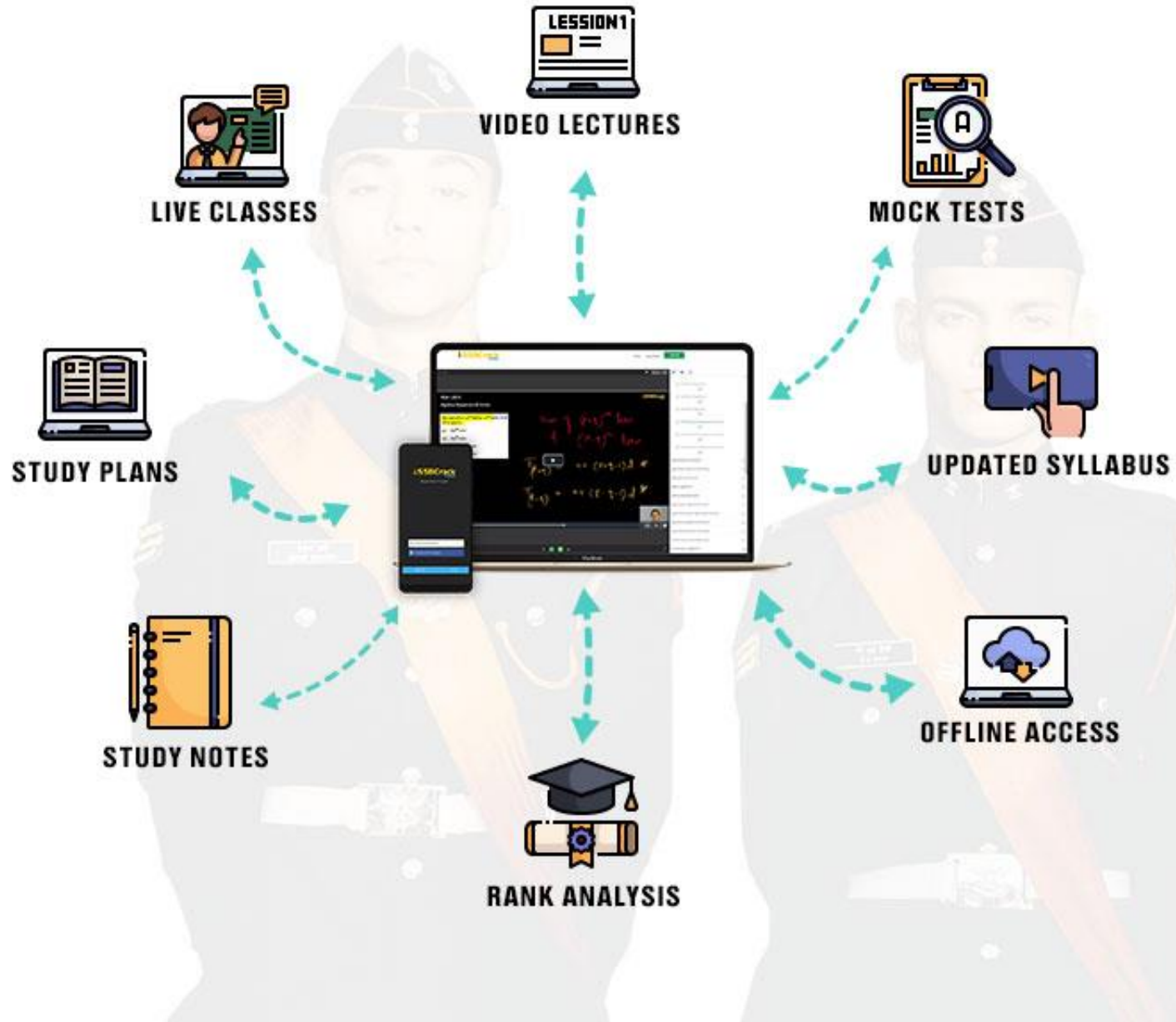

Choose from our Courses

SSB INTERVIEW ONLINE COURSE

USE CODE: "WARRIOR10"
FOR 10% OFF ON SSB COURSE

SSB Interview Online Course

17 courses ₹4999 **₹3999**



USE CODE: "WARRIOR10"
FOR 10% OFF ON NDA COURSE

NDA Exam Online Course
2022

23 courses ₹4999 **₹3999**



USE CODE: "WARRIOR10"
FOR 10% OFF ON CDS COURSE

CDS Exam Online Course
2022

39 courses ₹4999 **₹3999**



USE CODE: "WARRIOR10"
FOR 10% OFF ON AFCAT COURSE

AFCAT Exam Online Course
2022

23 courses ₹4999 **₹3999**



USE CODE: "WARRIOR10"
FOR 10% OFF ON OTA COURSE

CDS OTA Exam Online Course
2022

33 courses ₹4499 **₹3499**



USE CODE: "WARRIOR10"
FOR 10% OFF ON TA COURSE

Territorial Army Exam
Online Course 2022

45 courses ₹4999 **₹3999**



USE CODE: "WARRIOR10"
FOR 10% OFF ON MNS COURSE

MNS Exam Online Course
2022

21 courses ₹4999 **₹3999**



USE CODE: "WARRIOR10"
FOR 10% OFF ON ACC COURSE

ACC Exam Online Course
2022

24 courses ₹5999 **₹4999**

[View All](#)

Bundles 16[View All](#)

SSB Interview Online Course

17 Courses

₹3,999 ₹4,999 20% OFF



NDA Exam Online Course 2022

23 Courses

₹3,999 ₹4,999 20% OFF



CDS Exam Online Course 2022

39 Courses

₹3,999 ₹4,999 20% OFF



AFCAT Exam Online Course 2022

23 Courses

₹3,999 ₹4,999 20% OFF

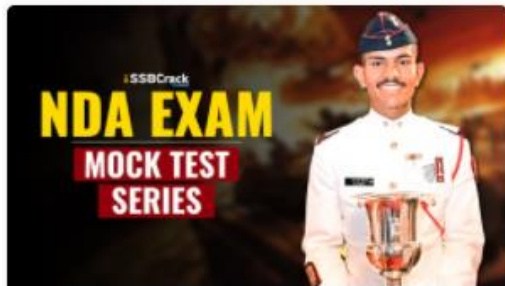
Test Series 07[View All](#)

NDA 2022 Mock Test Series

40 Tests

₹499 ₹999 50% OFF



CDS Exam 2022 Mock Test Series

30 Tests

₹499 ₹999 50% OFF



AFCAT 2022 Mock Test Series

20 Tests

₹499 ₹999 50% OFF



CDS Exam OTA 2022 Mock Test Series

20 Tests

₹499 ₹999 50% OFF

India's Most Popular Portal for Defence Exam Preparation

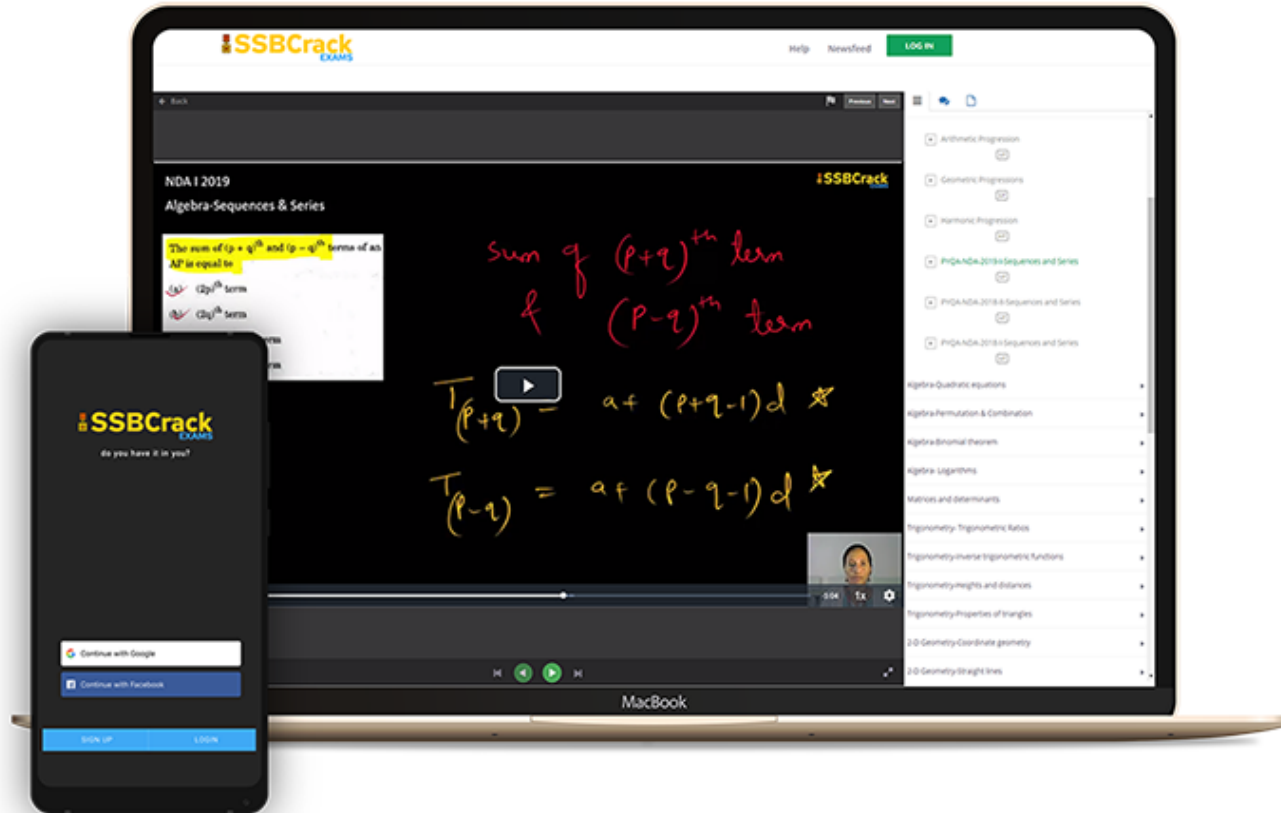

www.ssbcrackexams.com

CODE: WARRIOR10

get an extra **10%** off on all courses



AFCAT 2 2022

LIVE CLASS

TIME TABLE

DATE	TIME	SUBJECT
17 AUG 2022	10 AM TO 1 PM	General Awareness Part 1
17 AUG 2022	2 PM TO 5 PM	English Part 1
17 AUG 2022	6 PM TO 9 PM	Static GK Part 1
18 AUG 2022	10 AM TO 1 PM	General Awareness Part 2
18 AUG 2022	2 PM TO 5 PM	English Part 2
18 AUG 2022	6 PM TO 9 PM	Static GK Part 2
19 AUG 2022	10 AM TO 1 PM	Current Affairs
19 AUG 2022	2 PM TO 5 PM	English Part 3
19 AUG 2022	6 PM TO 9 PM	Defence Current Affairs
20 AUG 2022	10 AM TO 1 PM	Numerical Ability Part 1
20 AUG 2022	2 PM TO 5 PM	Reasoning Part 1
20 AUG 2022	6 PM TO 9 PM	General Sciences
22 AUG 2022	10 AM TO 1 PM	Numerical Ability Part 2
22 AUG 2022	2 PM TO 5 PM	Reasoning Part 2
23 AUG 2022	10 AM TO 1 PM	Numerical Ability Part 3
23 AUG 2022	2 PM TO 5 PM	Reasoning Part 3



Q) Question Figures

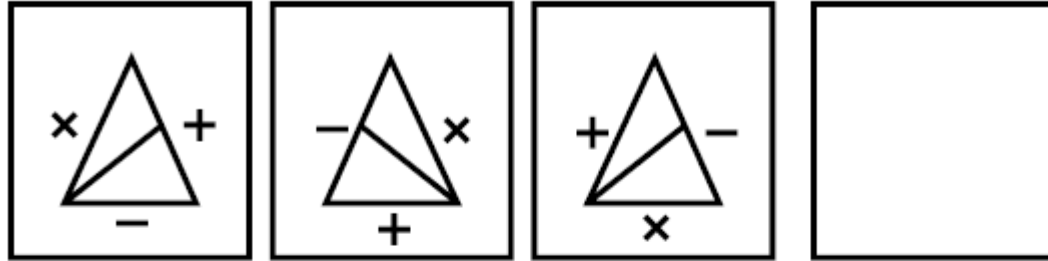

Answer Figures

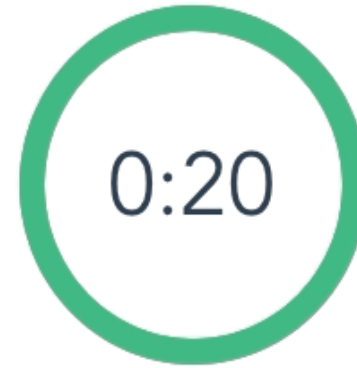
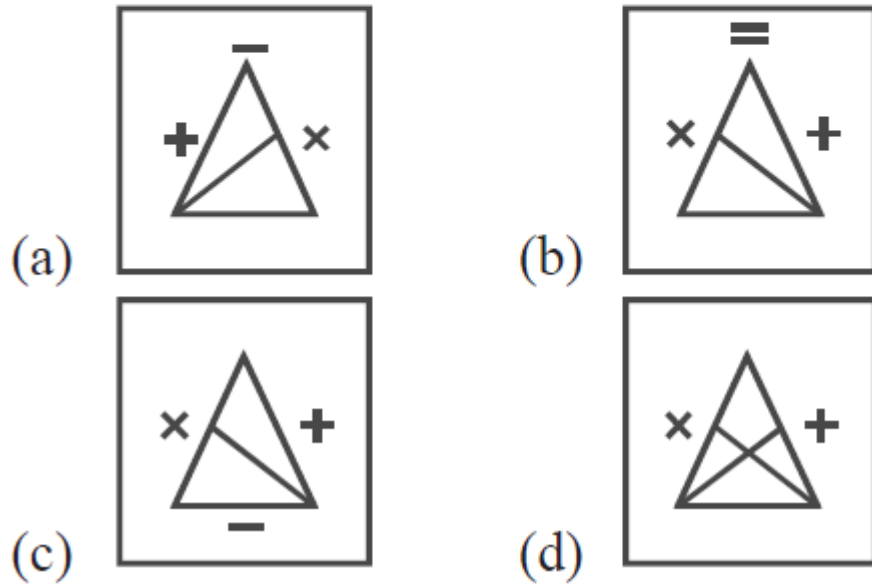

Q) Question Figures

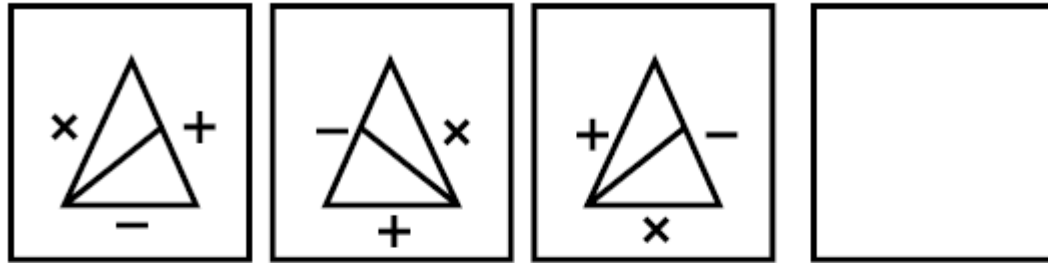

Answer Figures

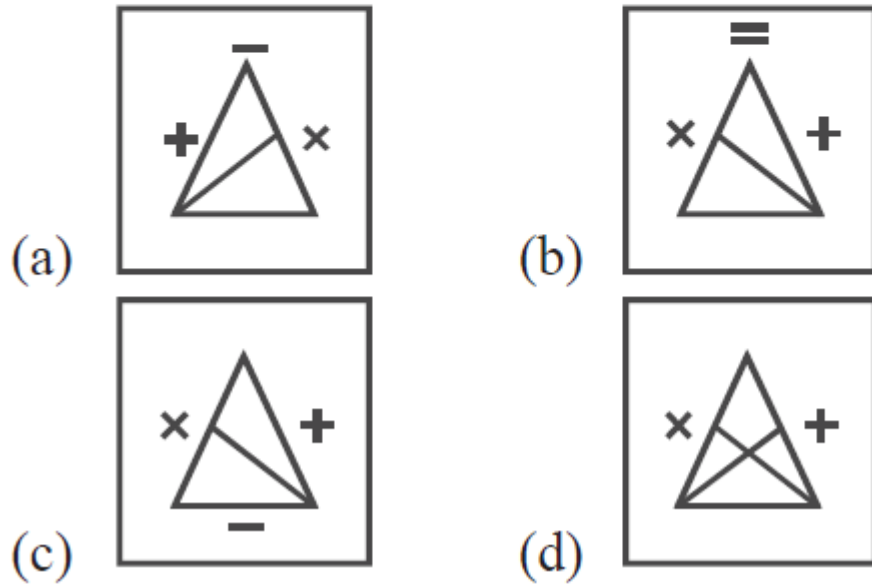

Ans: (c)

Q) Question Figure

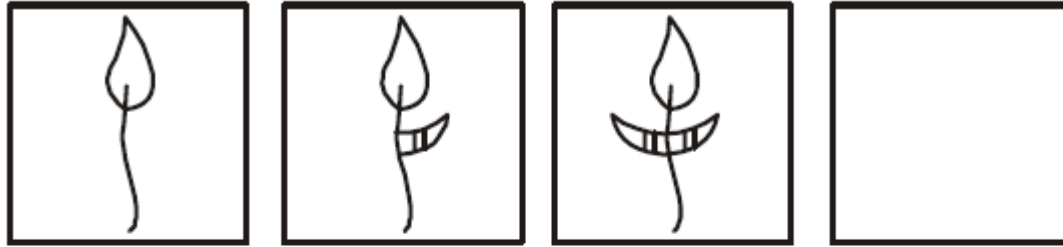

Answer Figures

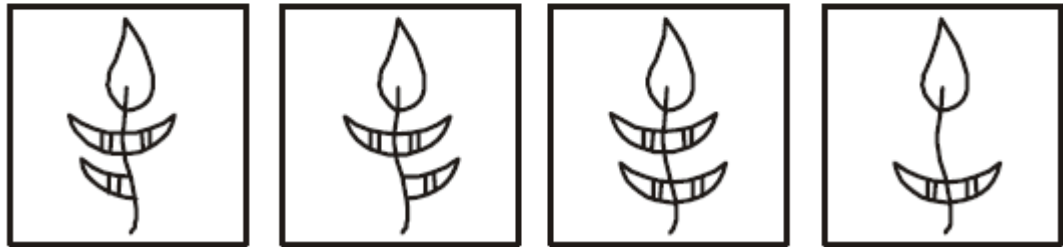

(a)

(b)

(c)

(d)

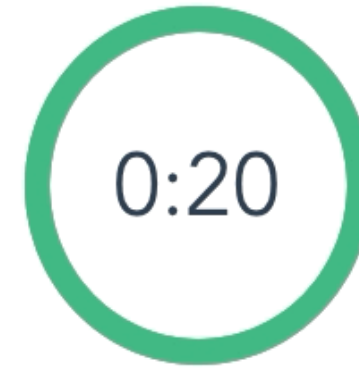

Q) Question Figure

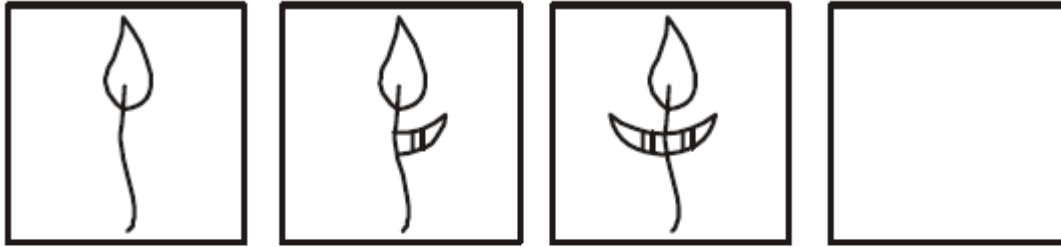

Answer Figures

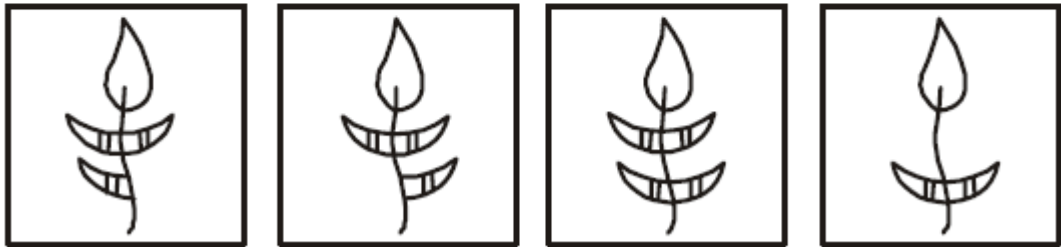

(a)

(b)

(c)

(d)

Ans: (b)

Q) Question Figure

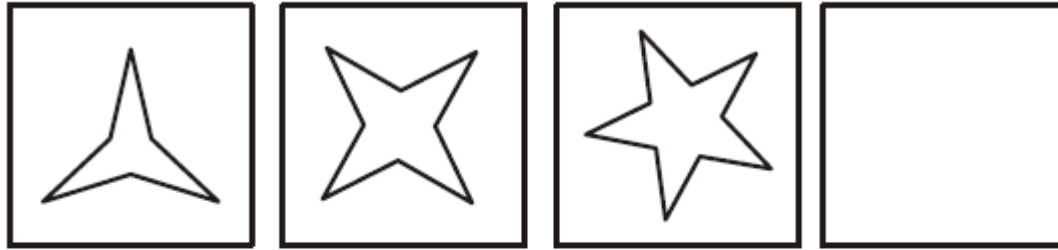

Answer Figures

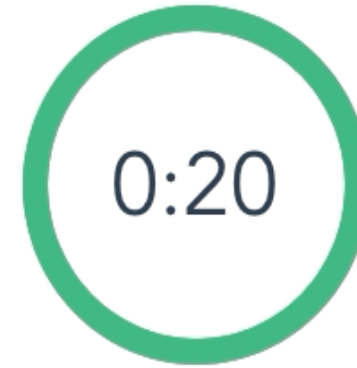
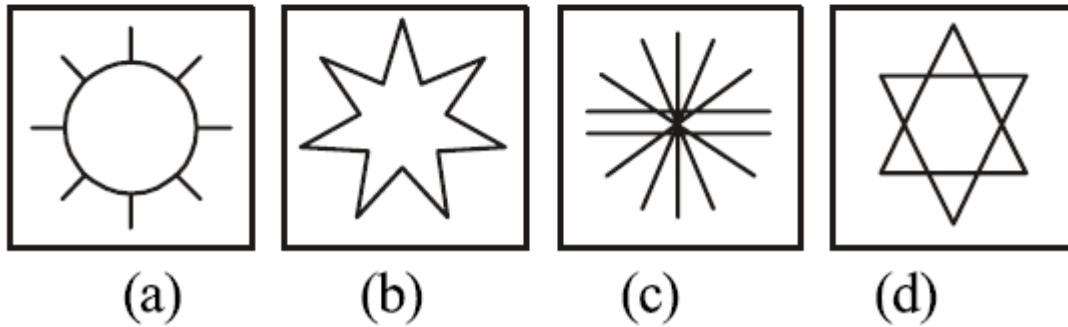

Q) Question Figure

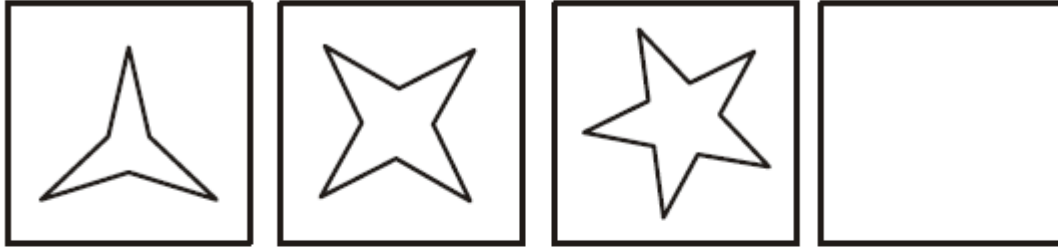

Answer Figures

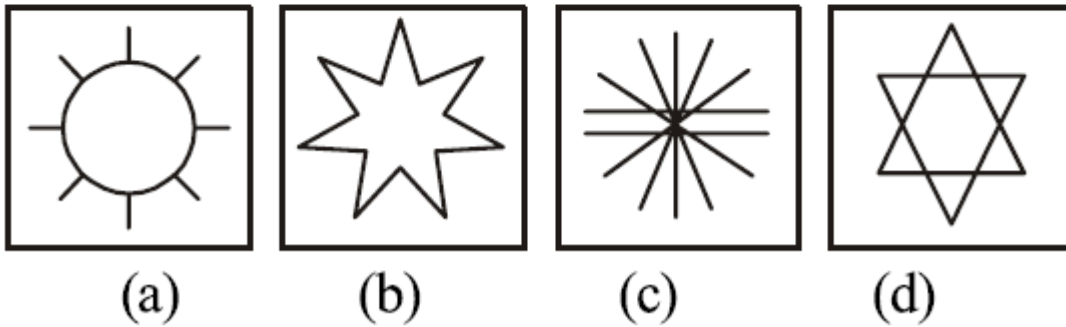

Ans: (d)

Q) Question Figure

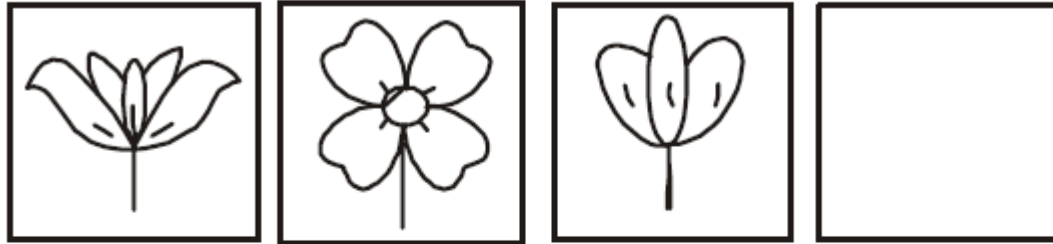

Answer Figures

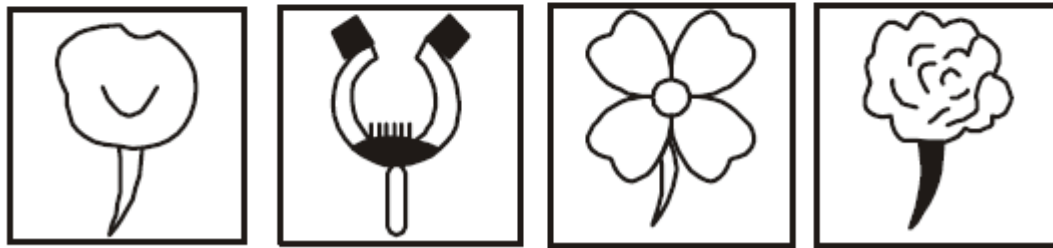

(a)

(b)

(c)

(d)

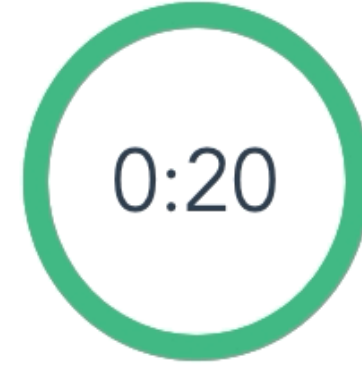

Q) Question Figure

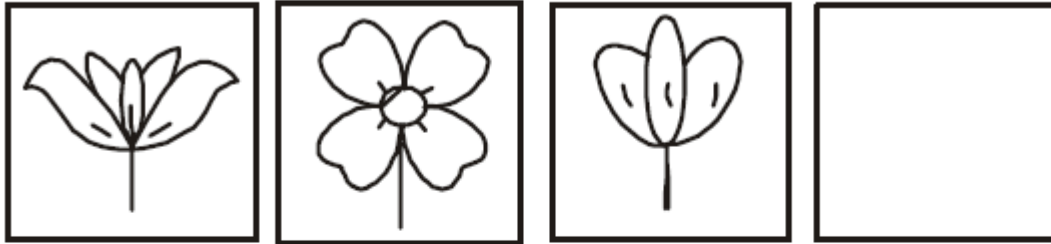

Answer Figures

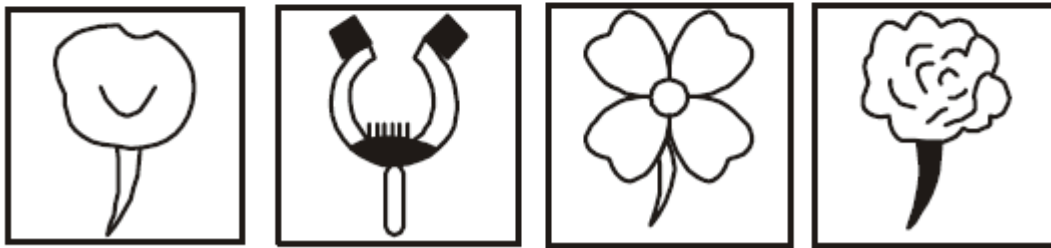

(a)

(b)

(c)

(d)

Ans: (b)

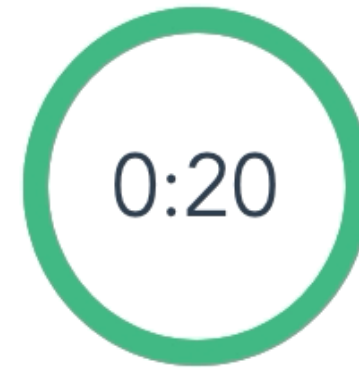
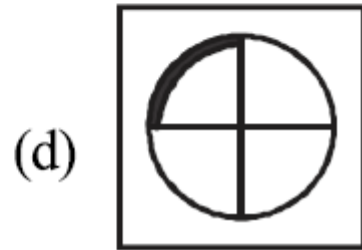
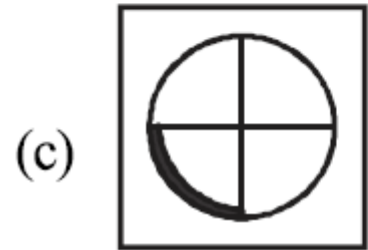
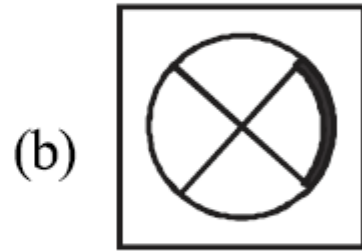
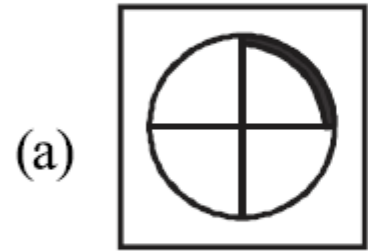
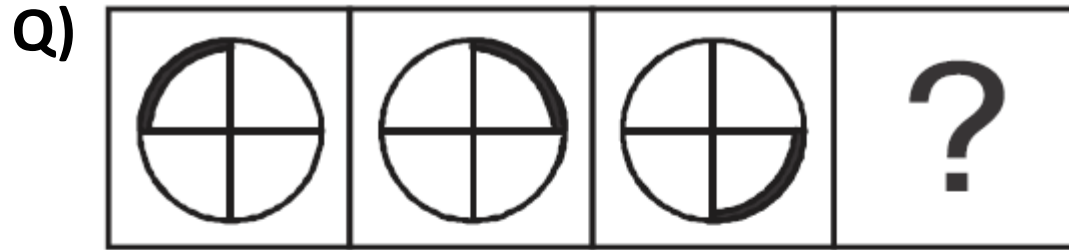

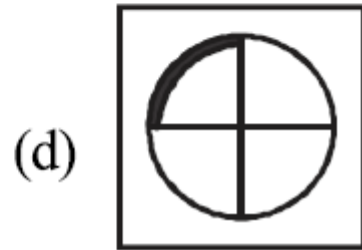
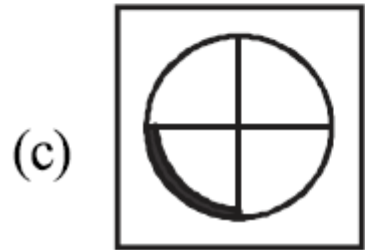
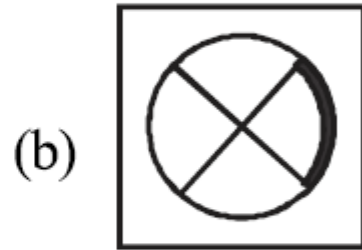
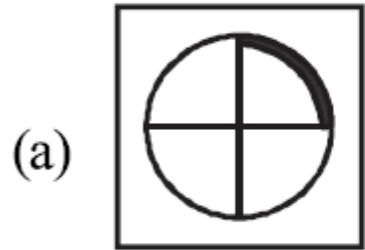
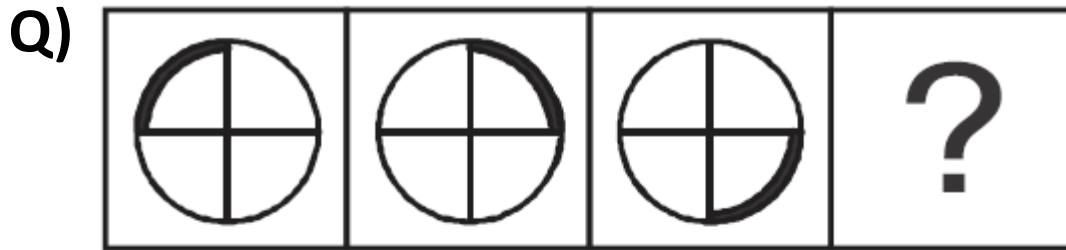

Ans: (c)

Q)

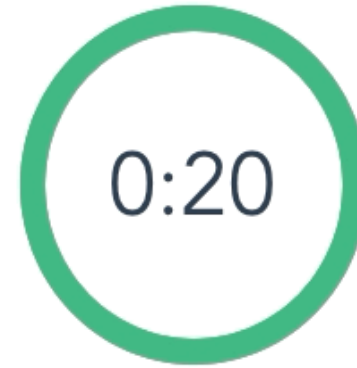
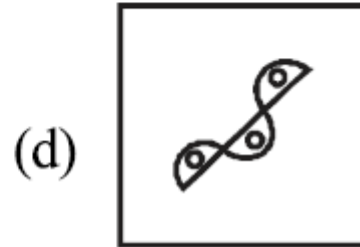
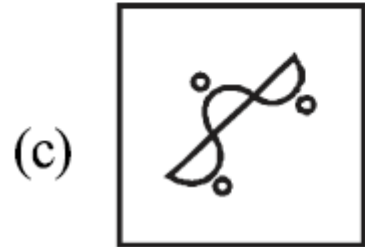
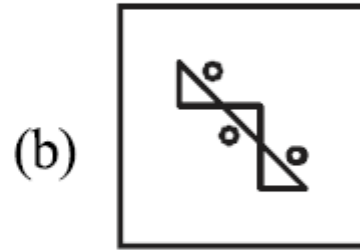
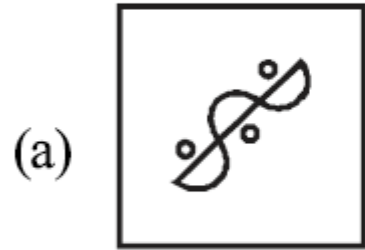
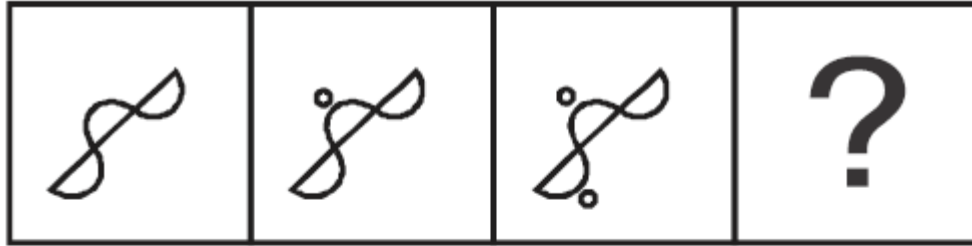

Q)

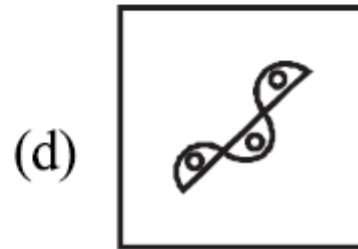
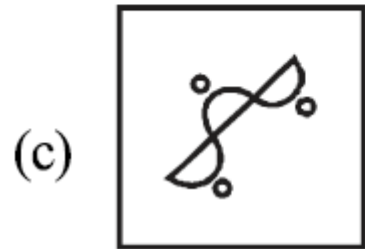
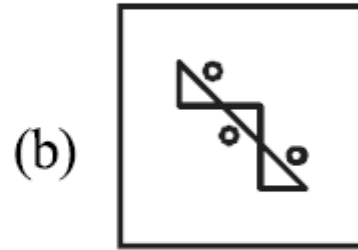
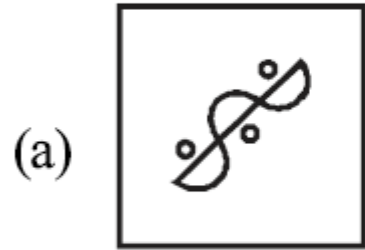
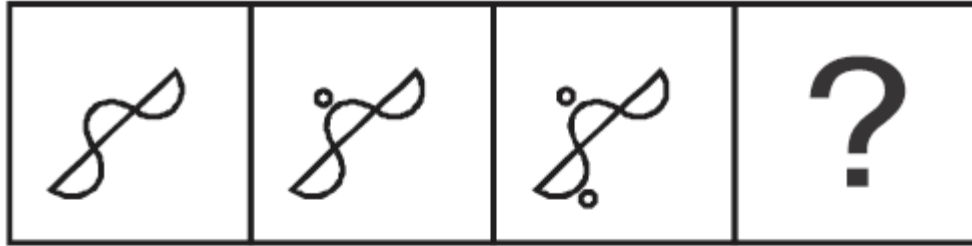

Ans: (c)

Q)

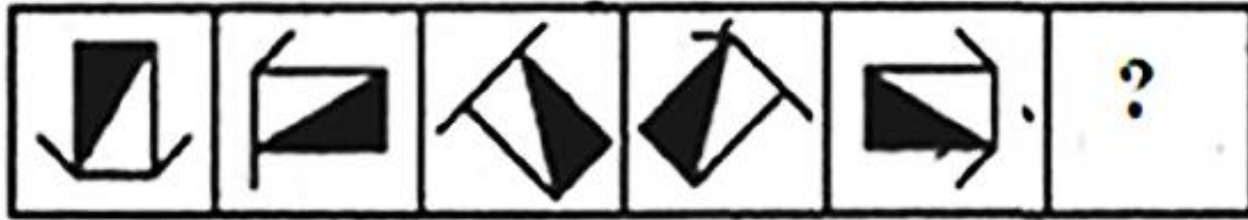

(a)



(b)



(c)



(d)



0:20

Q)

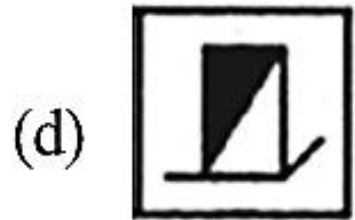
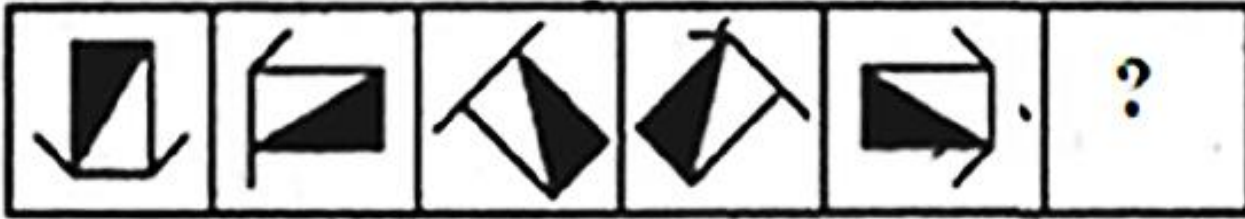

Ans: (c)

Q) Question Figures:

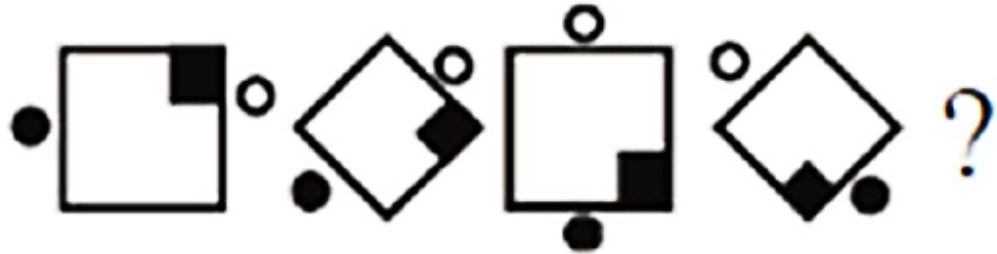

Answer Figures:



(a)

(b)

(c)

(d)

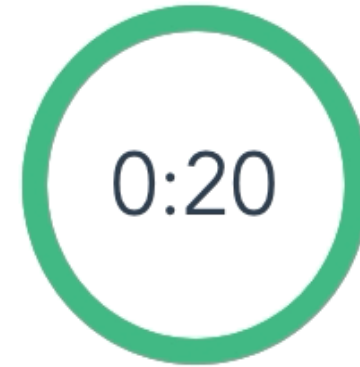

Q) Question Figures:

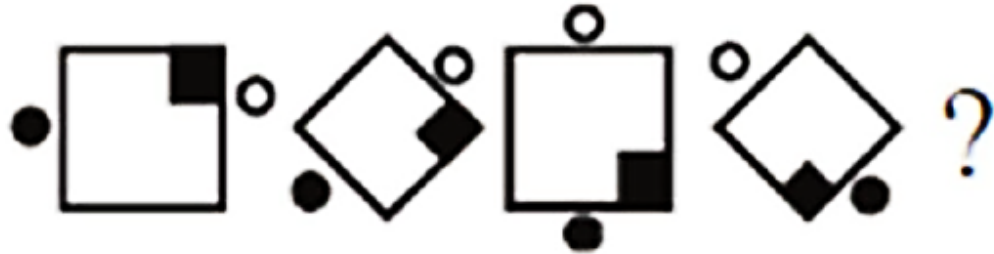

Answer Figures:



(a)

(b)

(c)

(d)

Ans: (c)

Q) Question Figures:



Answer Figures:



(a) (b) (c) (d)

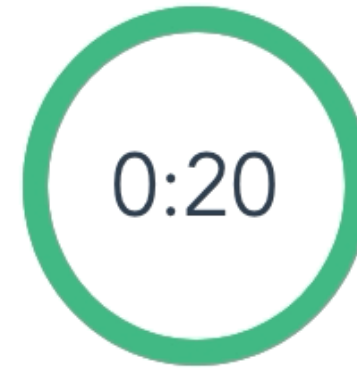

Q) Question Figures:



Answer Figures:



(a) (b) (c) (d)

Ans: (d)

Q) Question Figures:

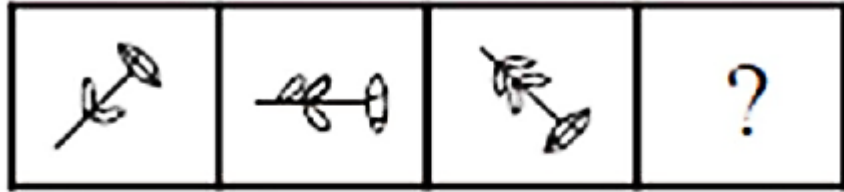

Answer Figures:

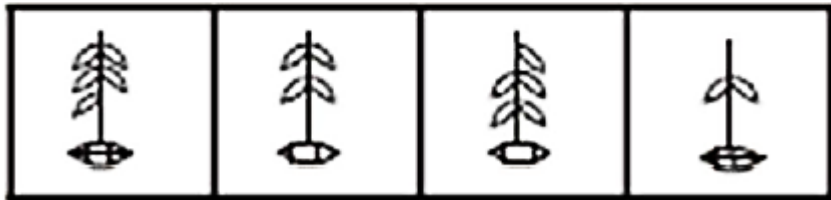

(a)

(b)

(c)

(d)

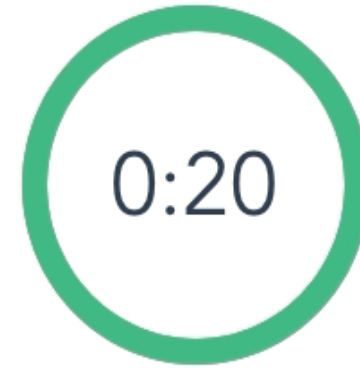

Q) Question Figures:

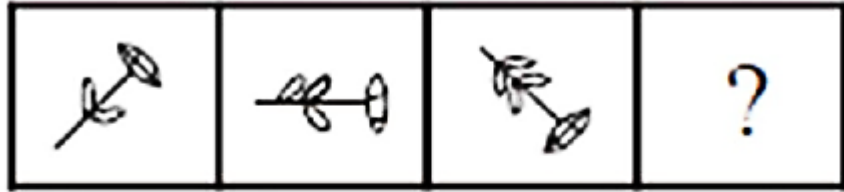

Answer Figures:

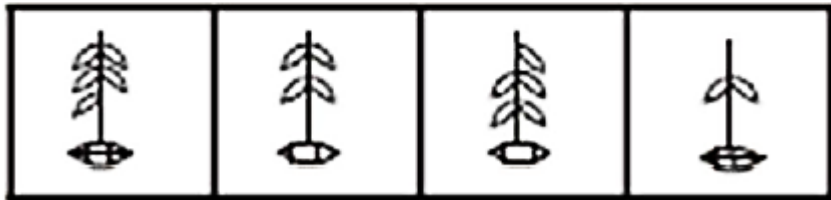

(a)

(b)

(c)

(d)

Ans: (c)

Q) Question Figures:

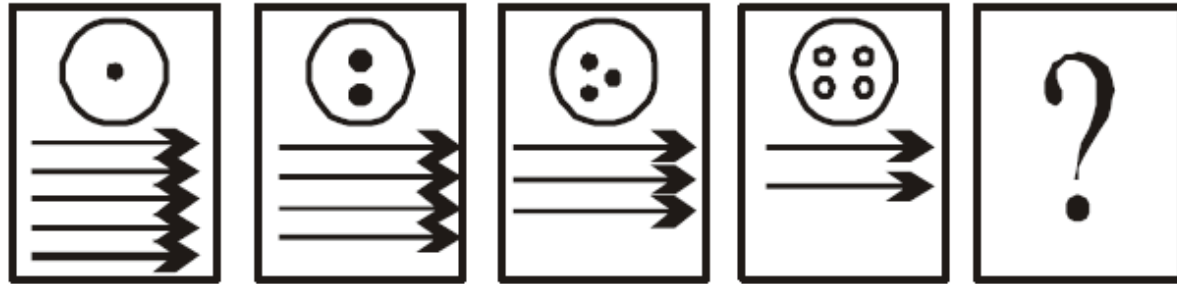

Answer Figures:

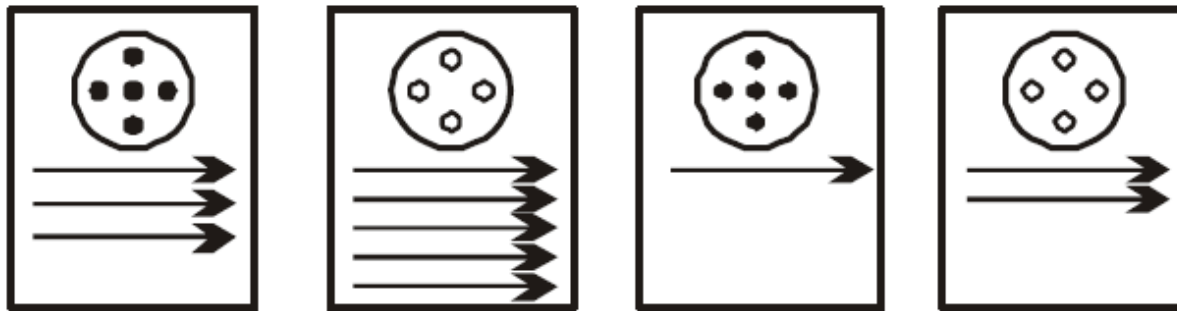

(a)

(b)

(c)

(d)

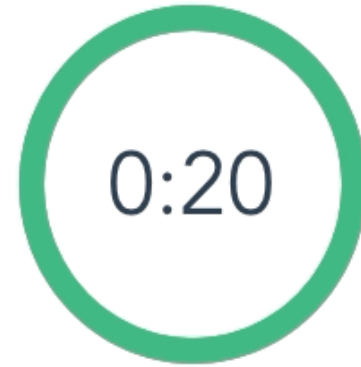

Q) Question Figures:

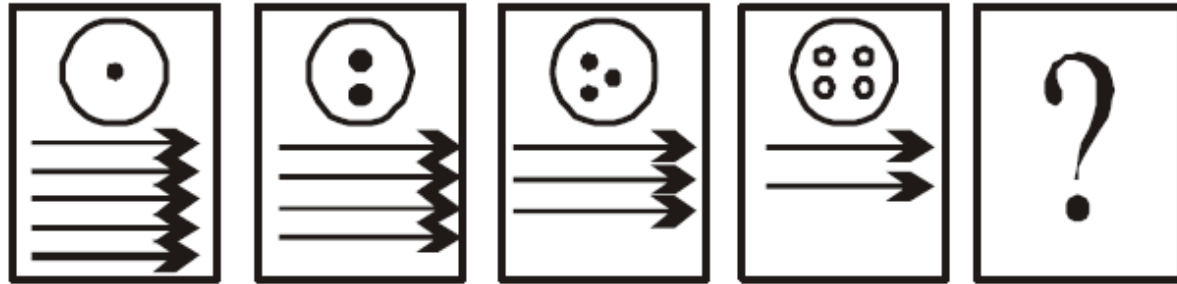

Answer Figures:

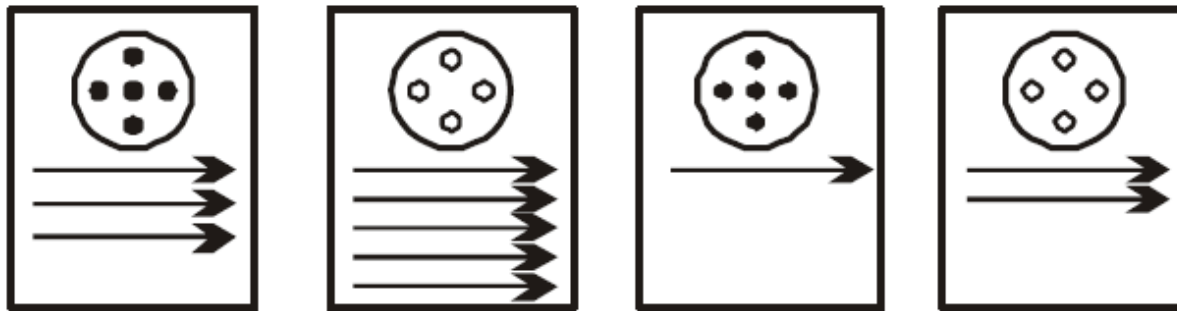

(a)

(b)

(c)

(d)

Ans: (c)

Q) Question Figure:

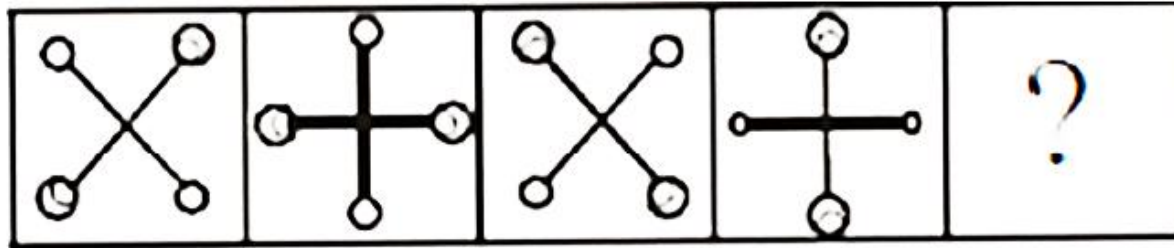

Answer Figure:

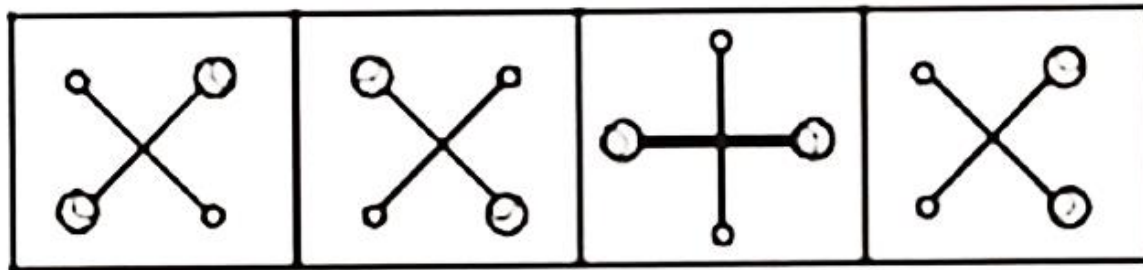

(a)

(b)

(c)

(d)

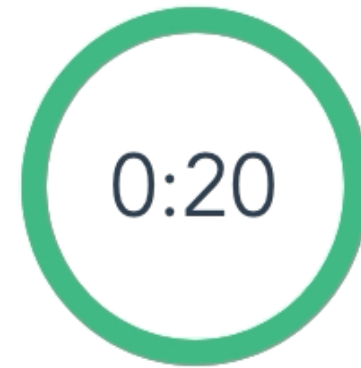

Q) Question Figure:

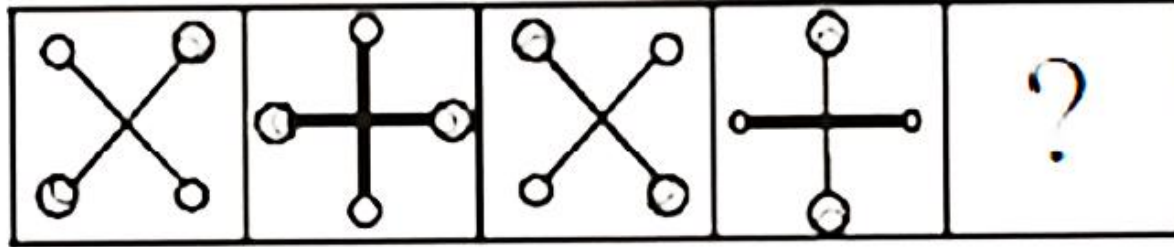

Answer Figure:

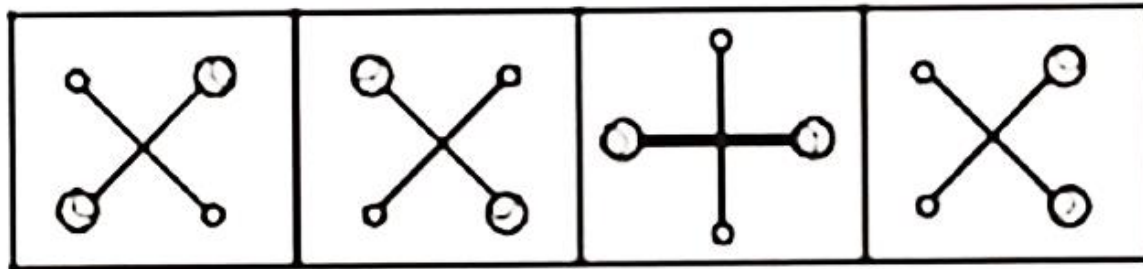

(a)

(b)

(c)

(d)

Ans: (a)

Q) Question Figure:

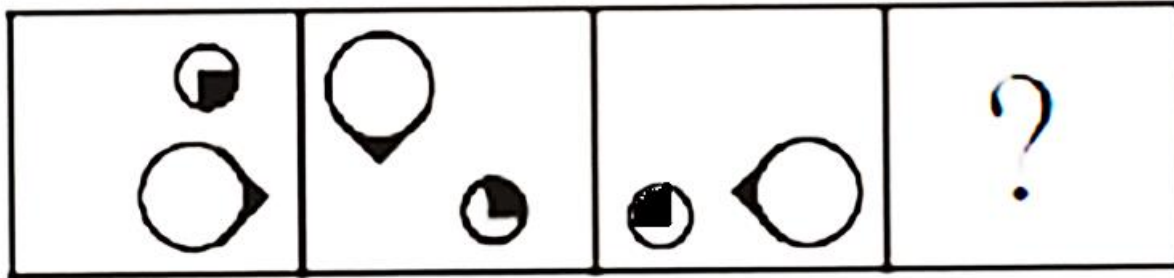

Answer Figure:

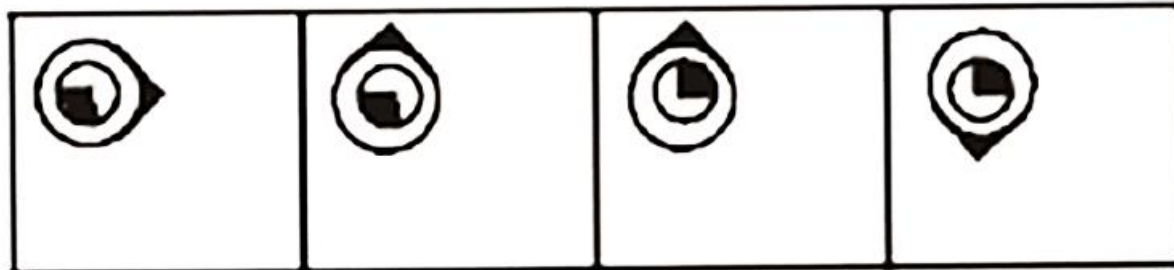

(a)

(b)

(c)

(d)

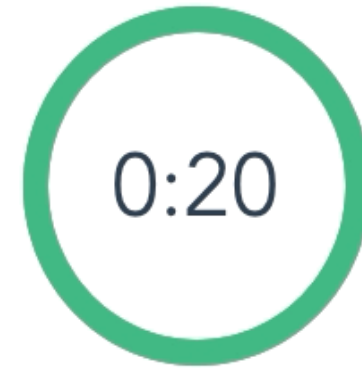

Q) Question Figure:

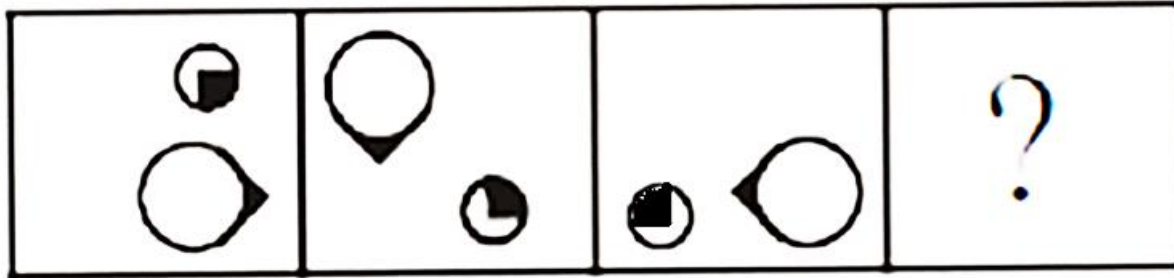

Answer Figure:

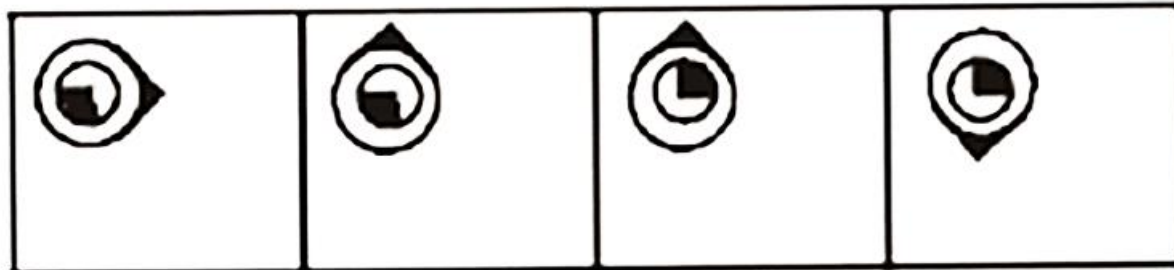

(a)

(b)

(c)

(d)

Ans: (b)

Q) Question Figure:

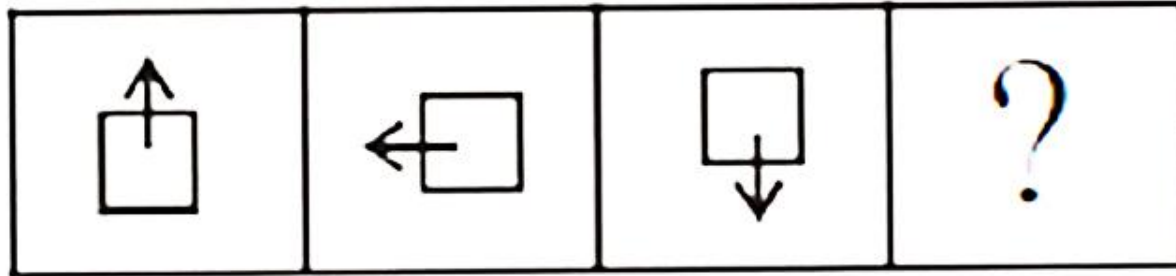

Answer Figure:

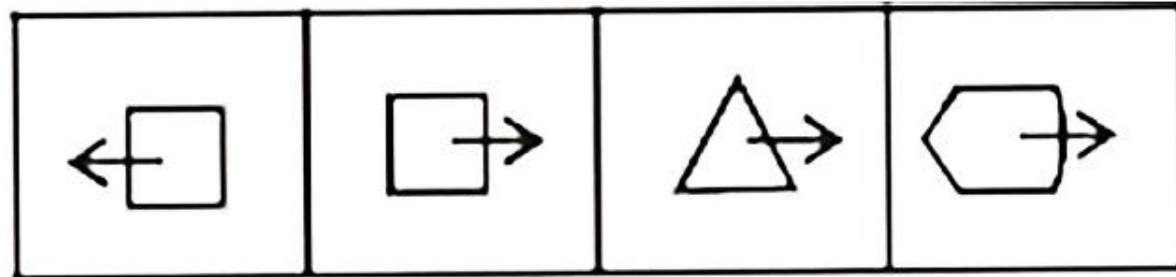

(a)

(b)

(c)

(d)

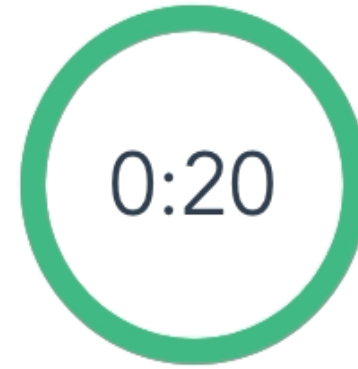

Q) Question Figure:

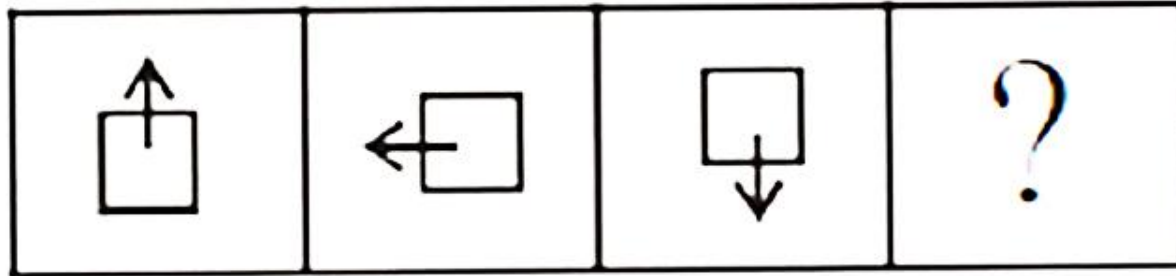

Answer Figure:

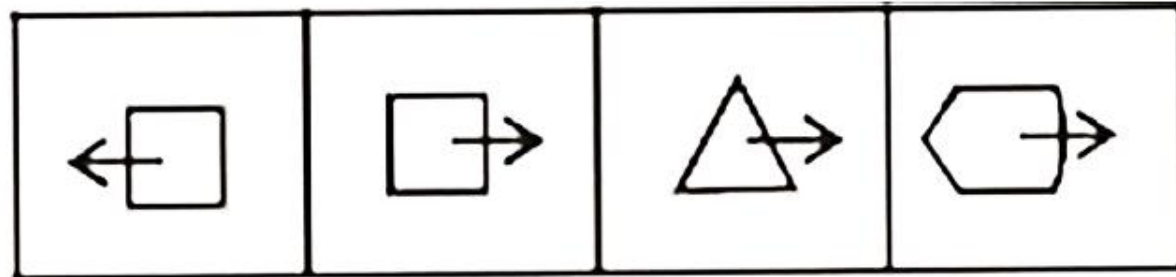

(a)

(b)

(c)

(d)

Ans: (b)

Q) Question Figures :

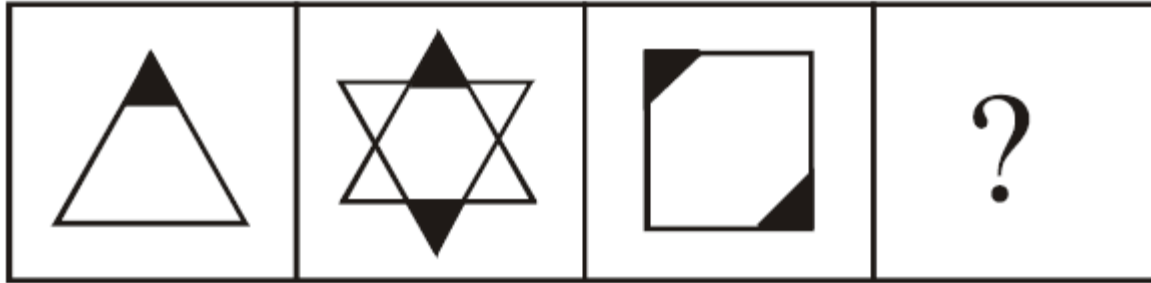

Answer Figures :

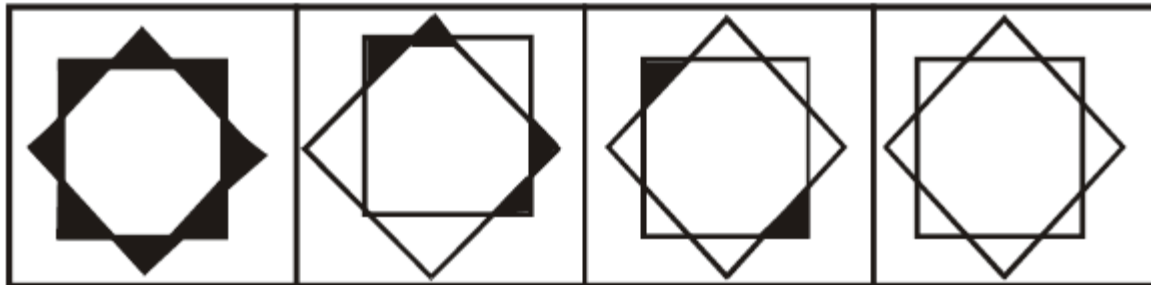

(a)

(b)

(c)

(d)

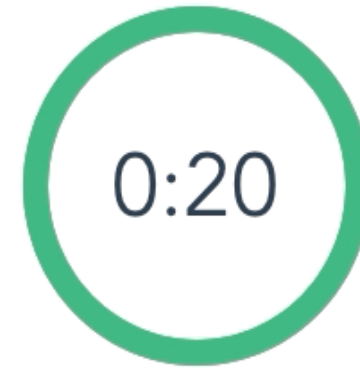

Q) Question Figures :

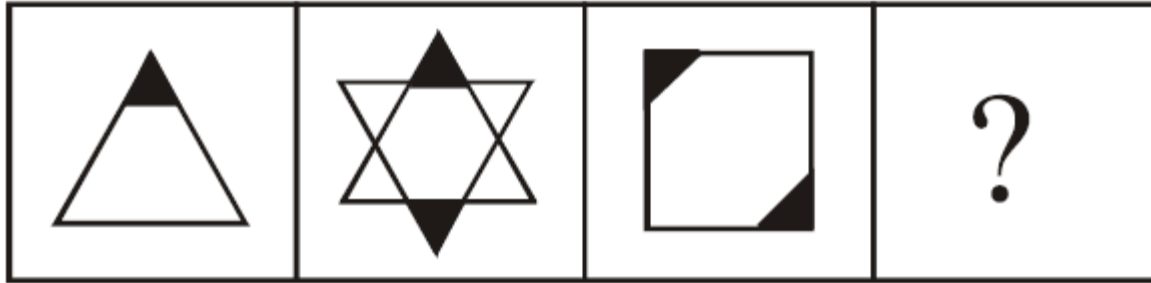

Answer Figures :

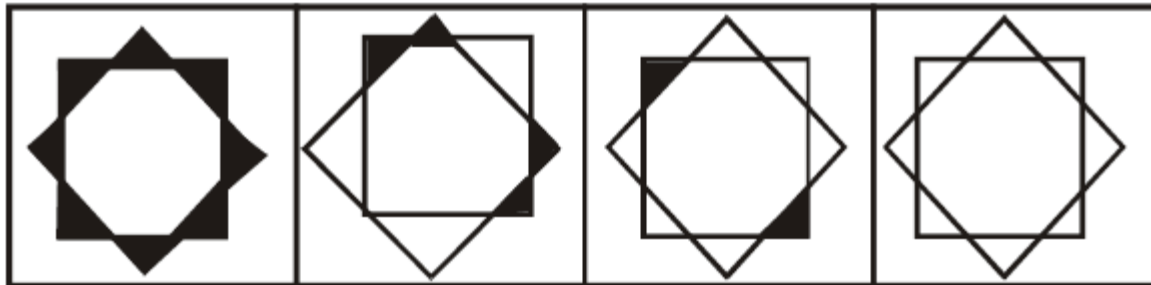

(a)

(b)

(c)

(d)

Ans: (c)

Q) Question Figures :

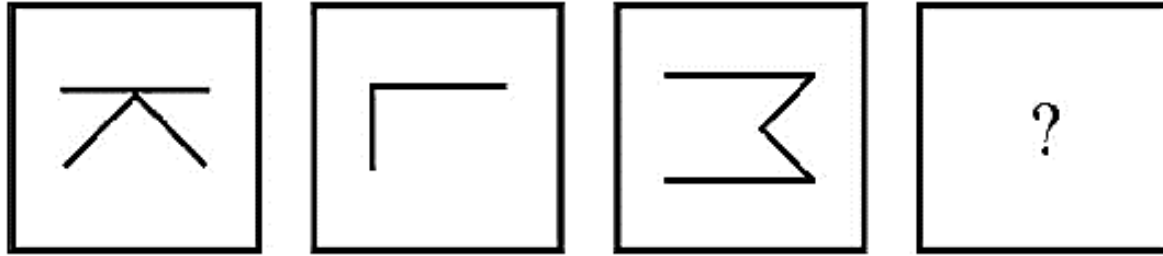

Answer Figures :

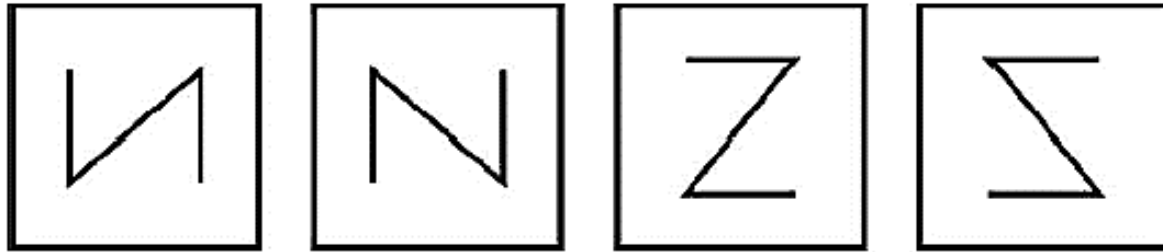

(a)

(b)

(c)

(d)

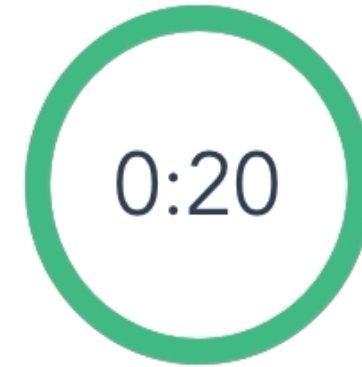

Q) Question Figures :

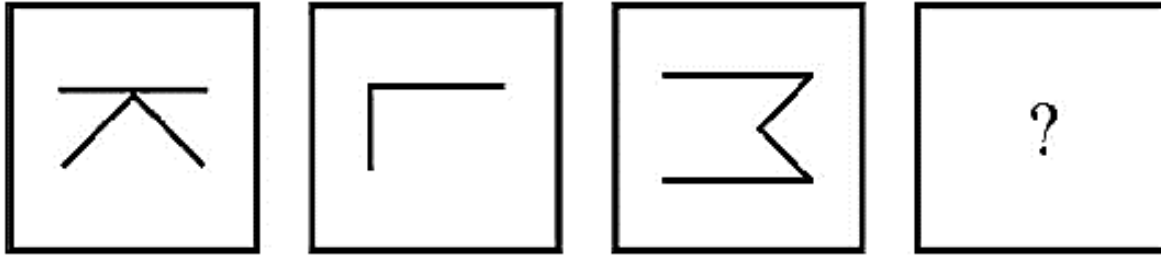

Answer Figures :

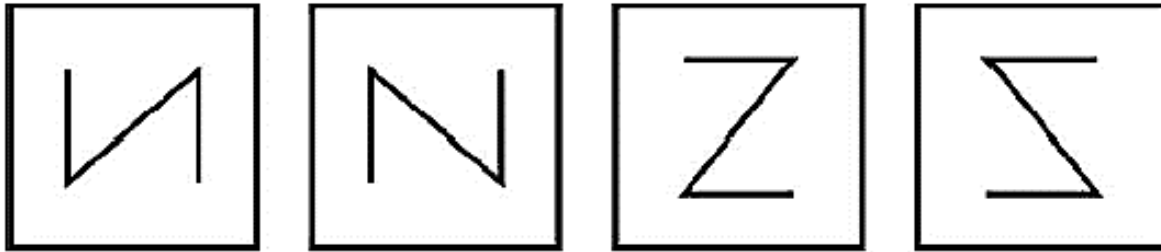

(a)

(b)

(c)

(d)

Ans: (c)

Q) Problem Figures:

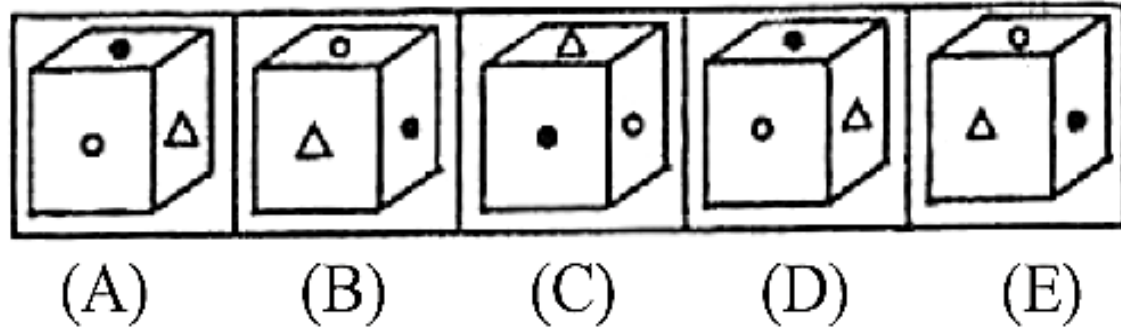

Answer Figures:

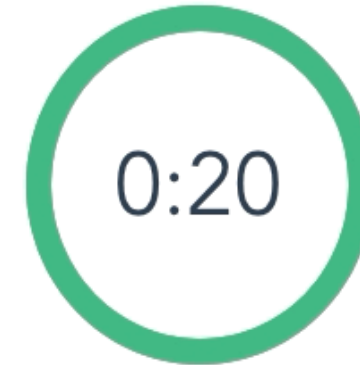
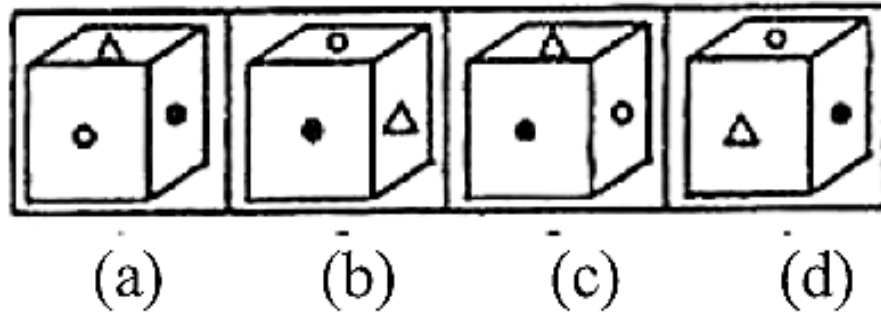

Q) Problem Figures:

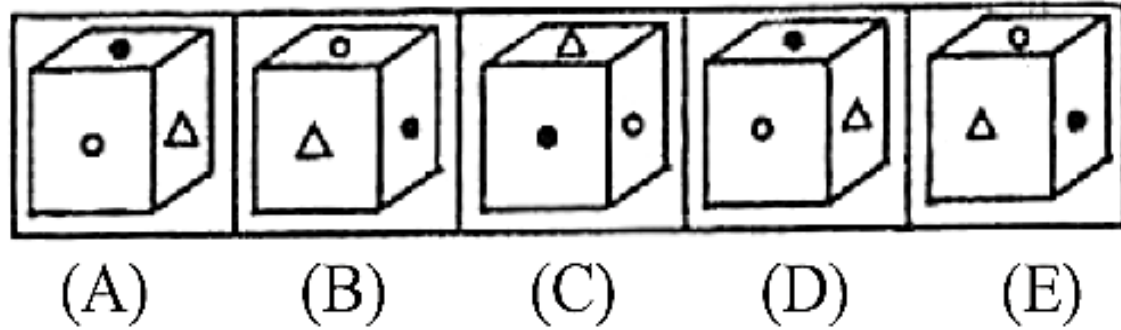

Answer Figures:

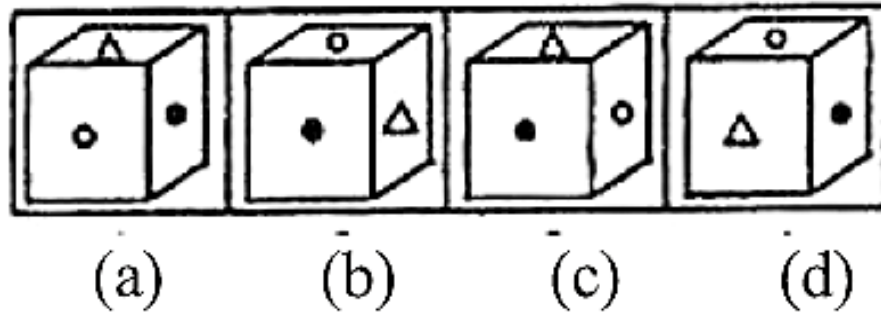

Ans: (c)

Q) Problem Figures:

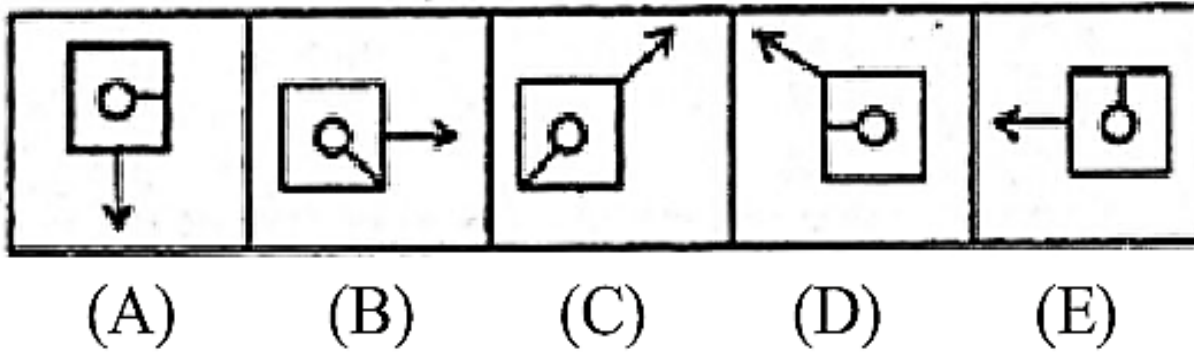

Answer Figures:

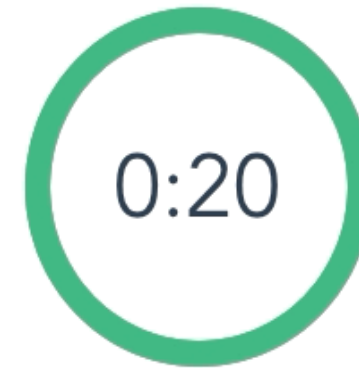
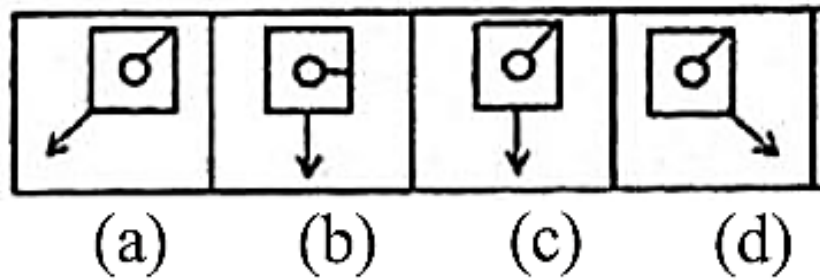

Q) Problem Figures:

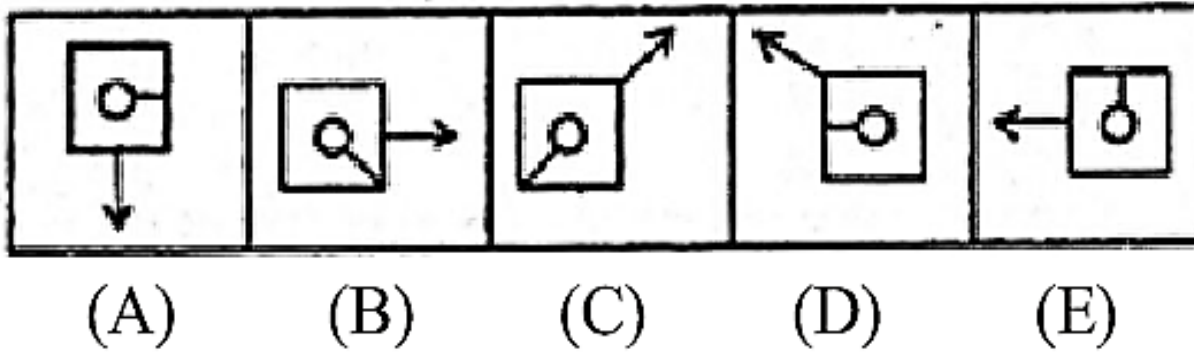

Answer Figures:

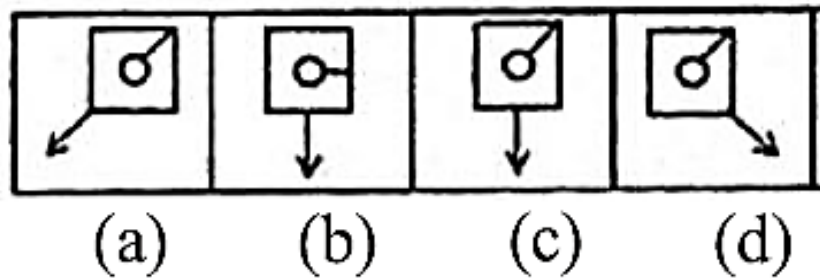

Ans: (c)

Q) Problem Figures:

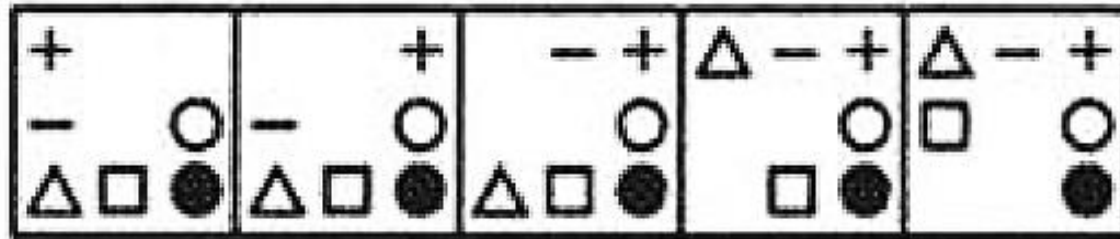

(A) (B) (C) (D) (E)

Answer Figures:

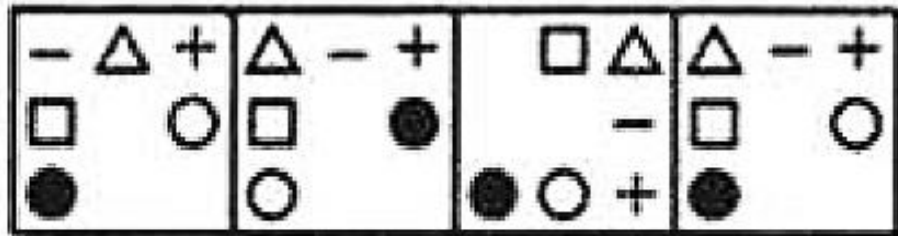

(a) (b) (c) (d)

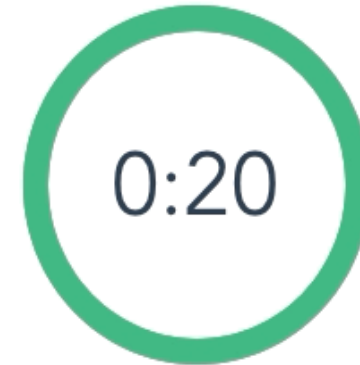

Q) Problem Figures:

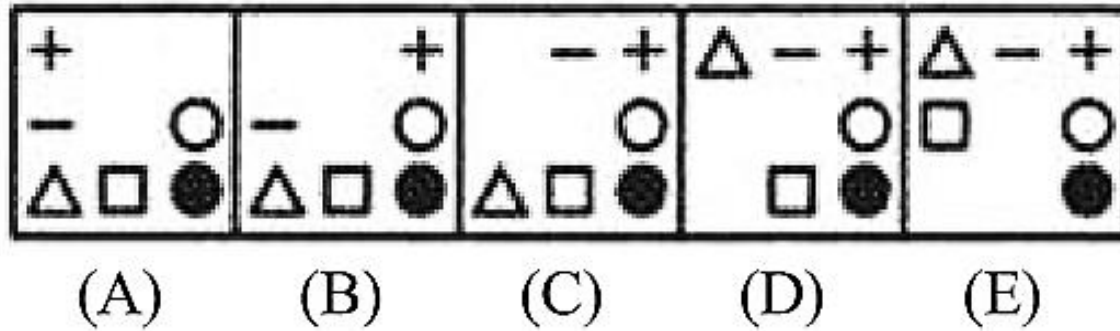

Answer Figures:

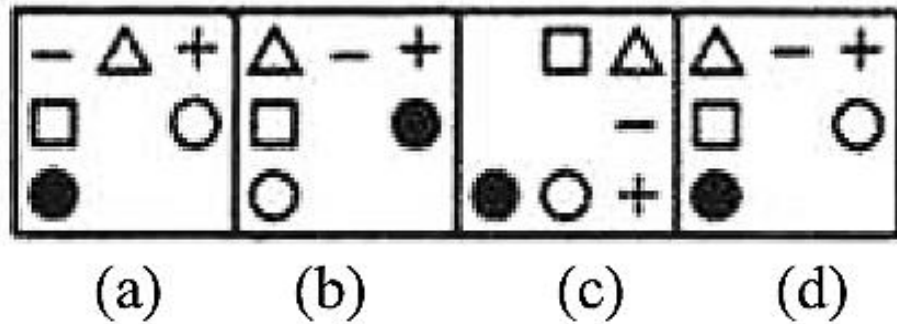

Ans: (d)

Q) Problem Figures:

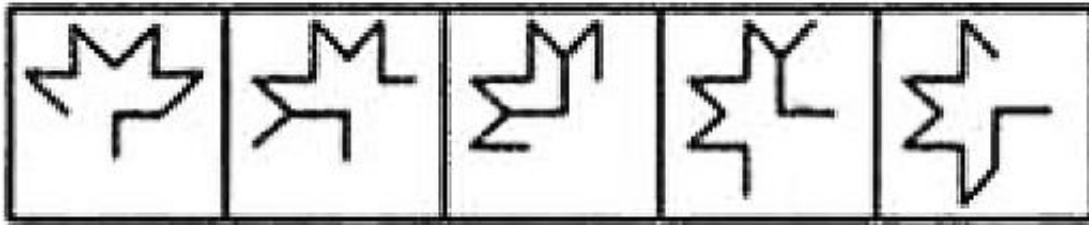

(A) (B) (C) (D) (E)

Answer Figures:

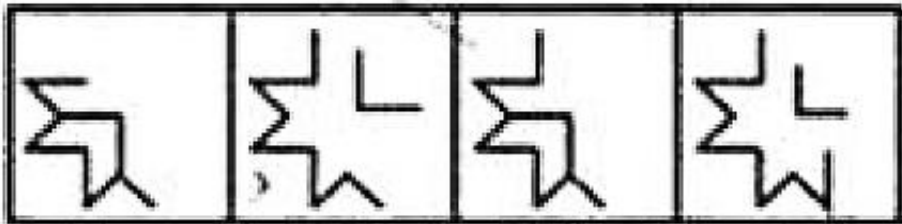

(a) (b) (c) (d)

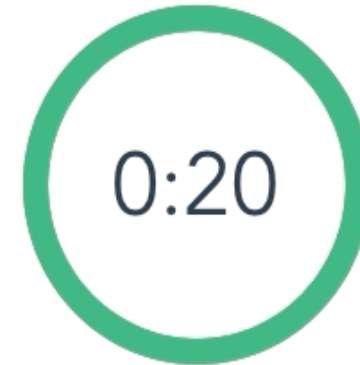

Q) Problem Figures:

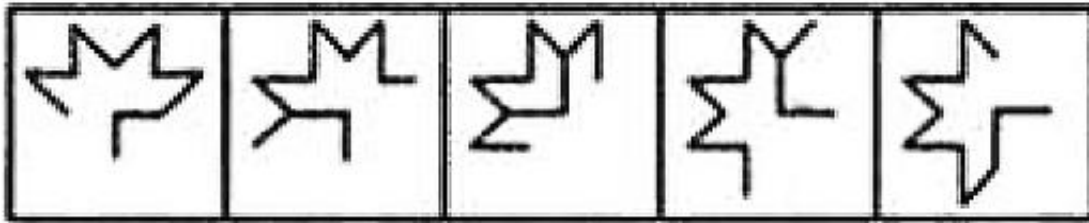

(A) (B) (C) (D) (E)

Answer Figures:

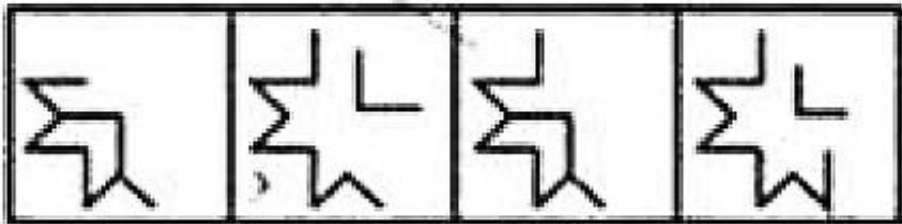

(a) (b) (c) (d)

Ans: (c)

Q) Problem Figures:

Answer Figures:

★ Z	D ○	□ Z	△ D	Z ⊠
S ○	□ ○	★ △	○ ⊠	T □
D ○	★ Z	D ○	Z □	△ D

T D	D T	△ D	△ □
△ =	= △	U =	U D
Z ⊠	⊠ Z	Z ⊠	Z ⊠

(1)

(2)

(3)

(4)

(5)

(a)

(b)

(c)

(d)

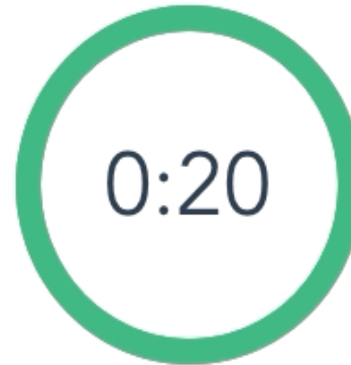

Q) Problem Figures:

Answer Figures:

★ Z	D ○	□ Z	△ D	Z ⊠
S ○	□ ○	★ △	○ ⊠	T □
D ○	★ Z	D ○	Z □	△ D

T D	D T	△ D	△ □
△ =	= △	U =	U D
Z ⊠	⊠ Z	Z ⊠	Z ⊠

(1)

(2)

(3)

(4)

(5)

(a)

(b)

(c)

(d)

Ans: (a)

Q) Problem Figures:

Answer Figures:

(1)	(2)	(3)	(4)	(5)

(a)	(b)	(c)	(d)

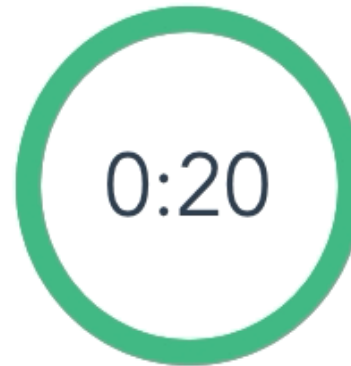

Q) Problem Figures:

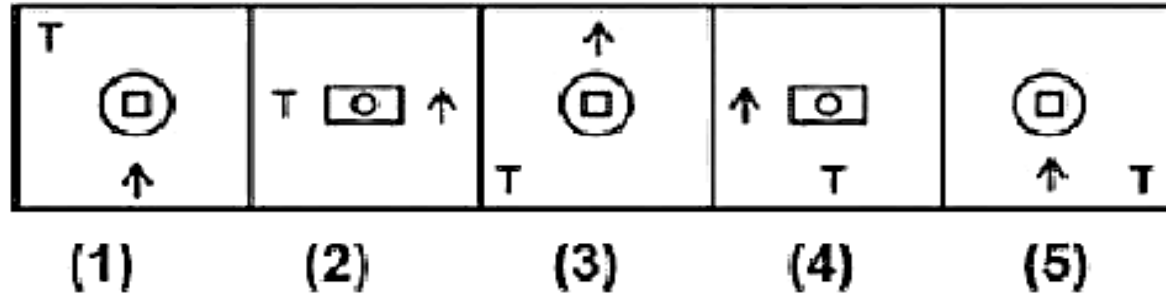

Answer Figures:

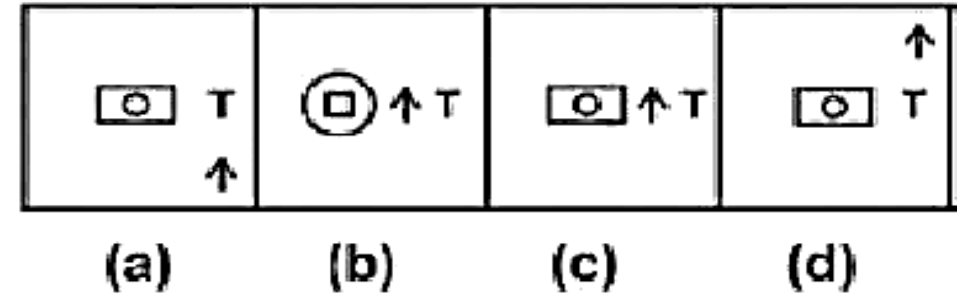

Ans: (c)

Q) Problem Figures:

Answer Figures

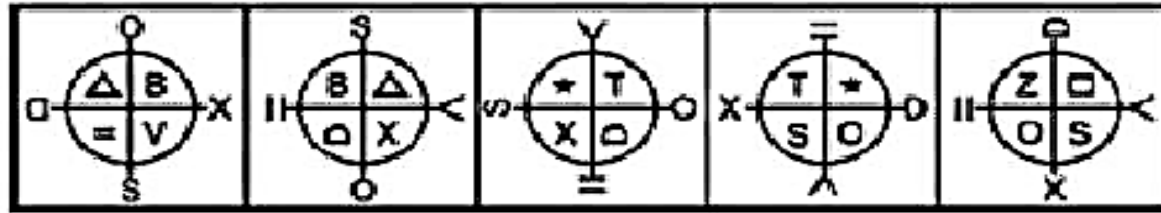

(1)

(2)

(3)

(4)

(5)

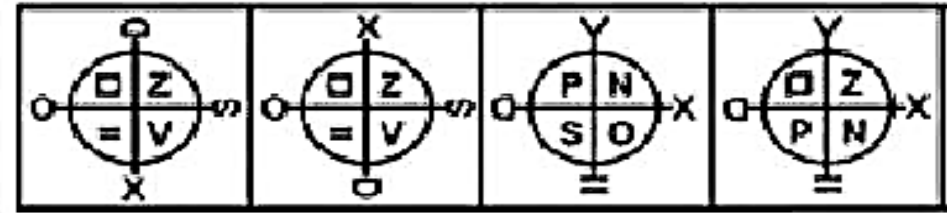

(a)

(b)

(c)

(d)

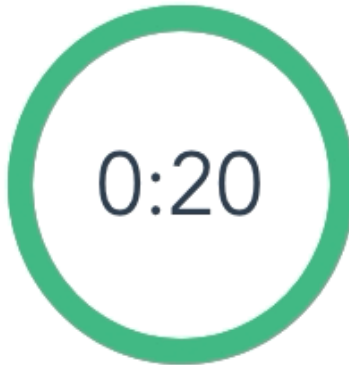

0:20

Q) Problem Figures:

Answer Figures

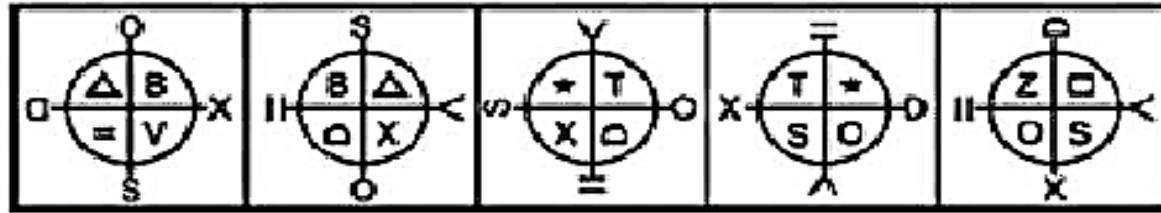

(1)

(2)

(3)

(4)

(5)

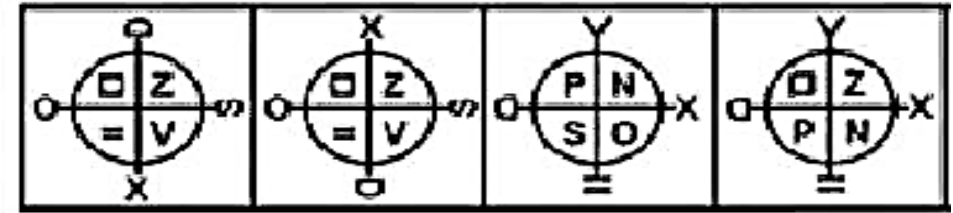

(a)

(b)

(c)

(d)

Ans: (b)

Q) Problem Figures:

Answer Figures:

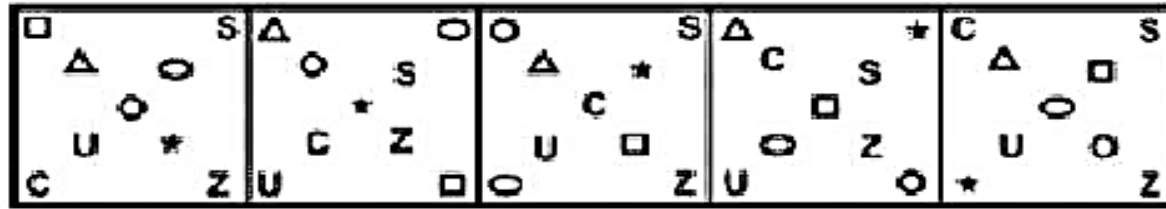

(1)

(2)

(3)

(4)

(5)

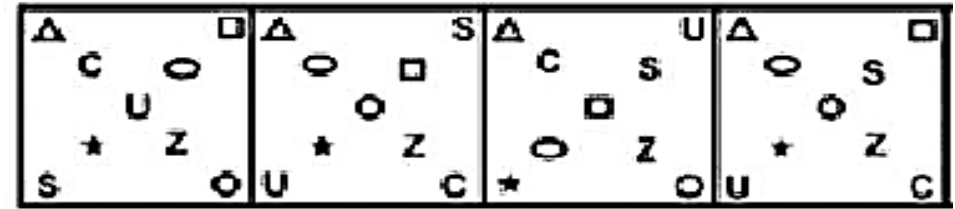

(a)

(b)

(c)

(d)

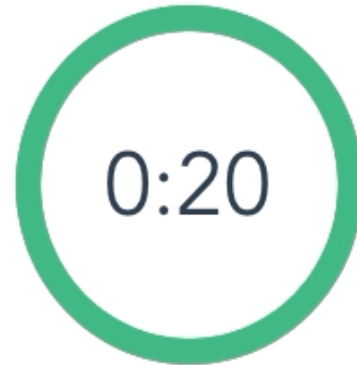

Q) Problem Figures:

Answer Figures:

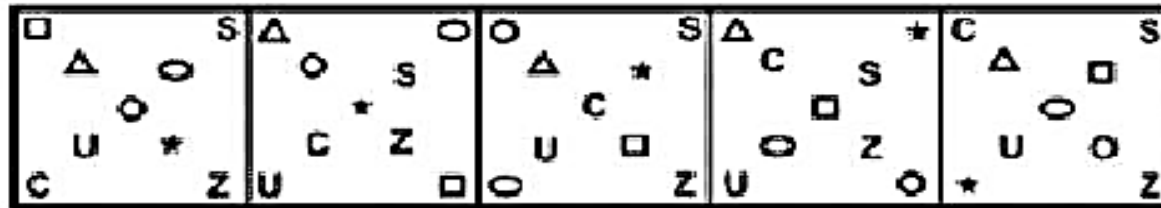

(1)

(2)

(3)

(4)

(5)

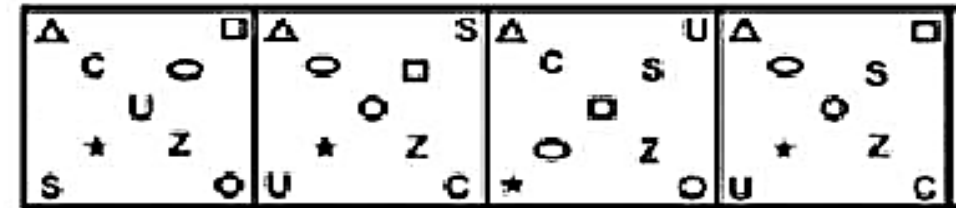

(a)

(b)

(c)

(d)

Ans: (d)

Q)

Problem Figures:

Answer Figures:

P A S T E	T S A P O	A Z T D P	D T Z A V	Z O D V A
-----------	-----------	-----------	-----------	-----------

(1)

(2)

(3)

(4)

(5)

V D O Z L	D O Z A V	V O D Z L	D L Z A V
-----------	-----------	-----------	-----------

(a)

(b)

(c)

(d)

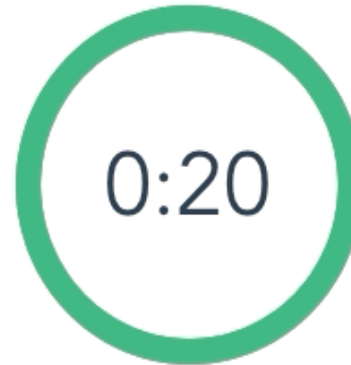

Q) Problem Figures:

P A S T E	T S A P O	A Z T D P	D T Z A V	Z O D V A
(1)	(2)	(3)	(4)	(5)

Answer Figures:

V D O Z L	D O Z A V	V O D Z L	D L Z A V
(a)	(b)	(c)	(d)

Ans: (a)

Q) Problem Figures:

Answer Figures:

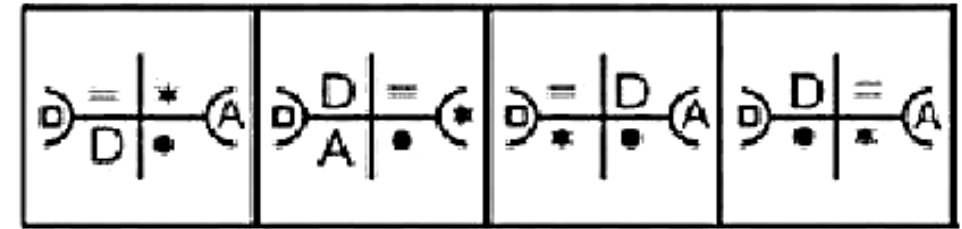
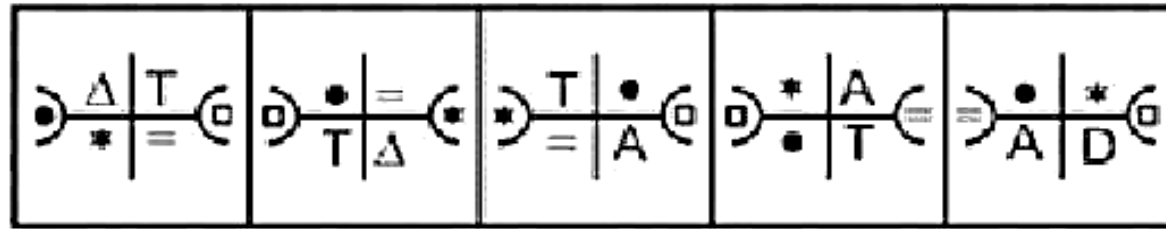

(1)

(2)

(3)

(4)

(5)

(a)

(b)

(c)

(d)

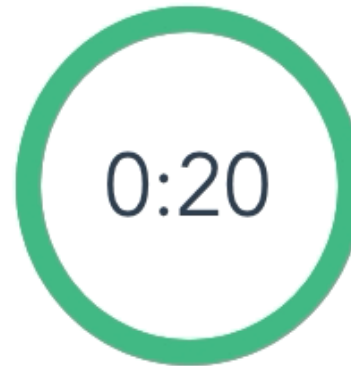

Q) Problem Figures:

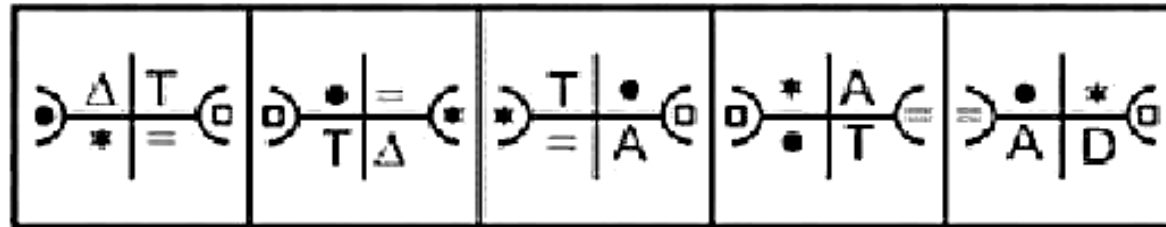

(1) (2) (3) (4) (5)

Answer Figures:

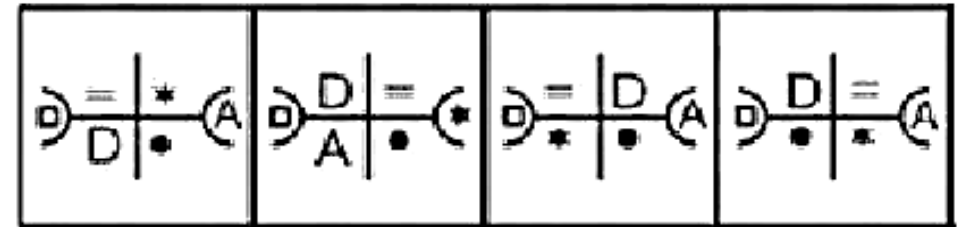

(a) (b) (c) (d)

Ans: (c)

Q) Problem Figures:

Answer Figures:

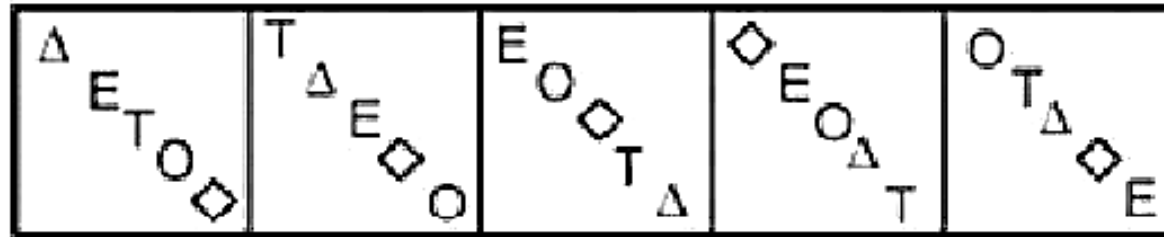

(1) (2) (3) (4) (5)

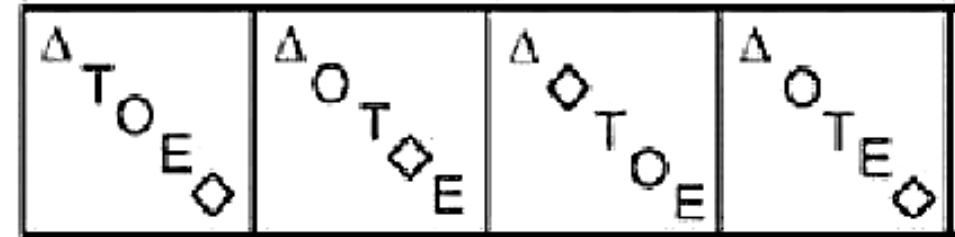

(a) (b) (c) (d)

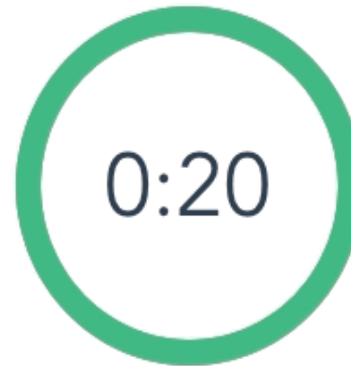

Q) Problem Figures:

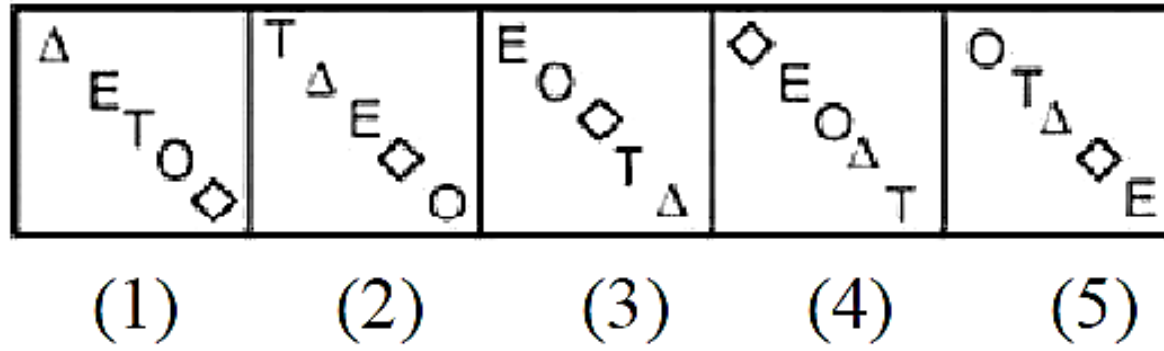

Answer Figures:

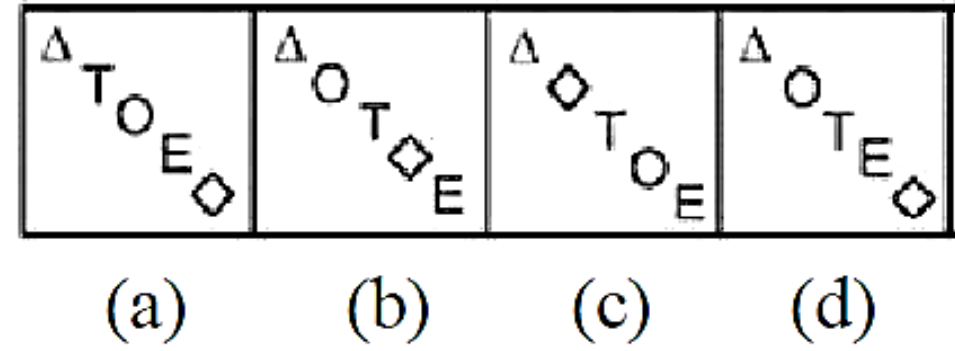

Ans: (d)

Q) Problem Figures:

Answer Figures:

D C ▲	U D C ▲	▲ C O U D	▲ C D = O	D U O C = ▲ ◆
(1)	(2)	(3)	(4)	(5)

= O ◆ U D C ▲	◆ = O U * D C ▲	= O U ◆ * D C ▲	O = ◆ U * D C ▲
(a)	(b)	(c)	(d)

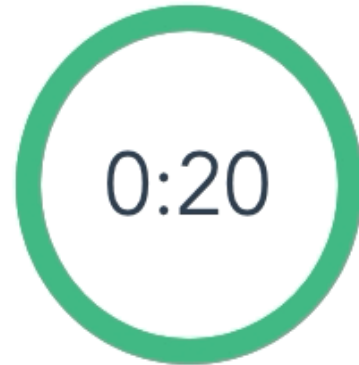

Q) Problem Figures:

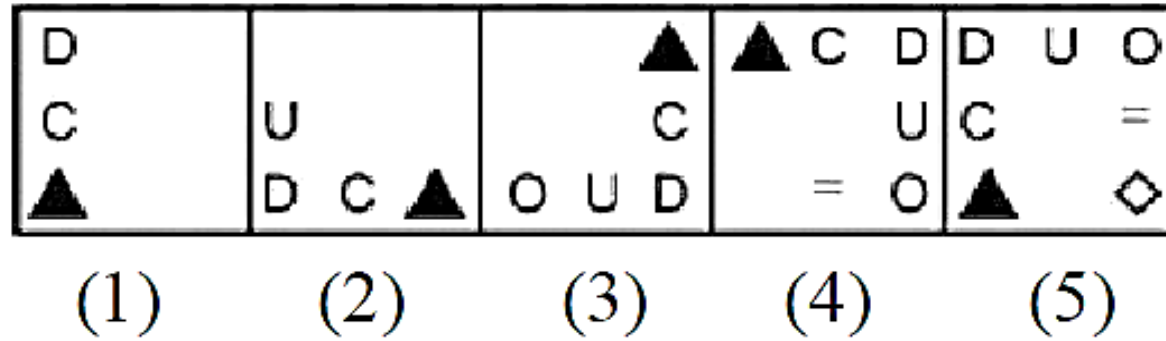

Answer Figures:

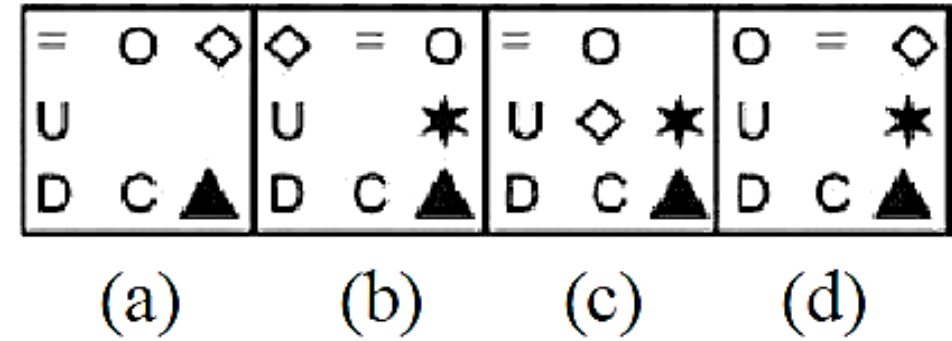

Ans: (d)

Q)

Problem Figures:

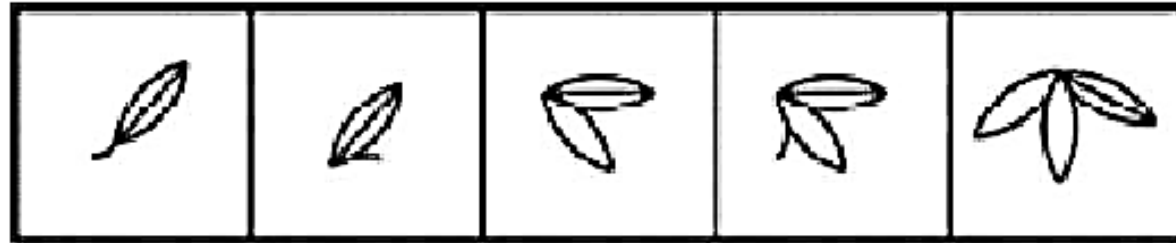

(1)

(2)

(3)

(4)

(5)

Answer Figures:



(a)

(b)

(c)

(d)

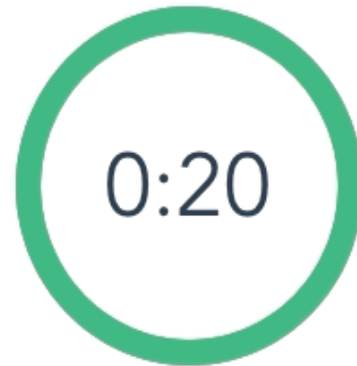

Q)

Problem Figures:

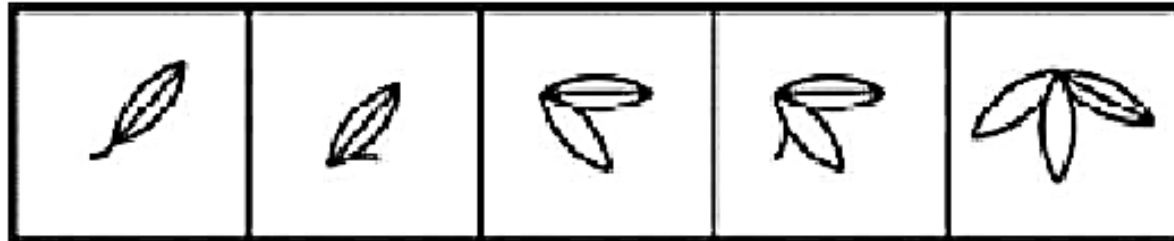

(1)

(2)

(3)

(4)

(5)

Answer Figures:

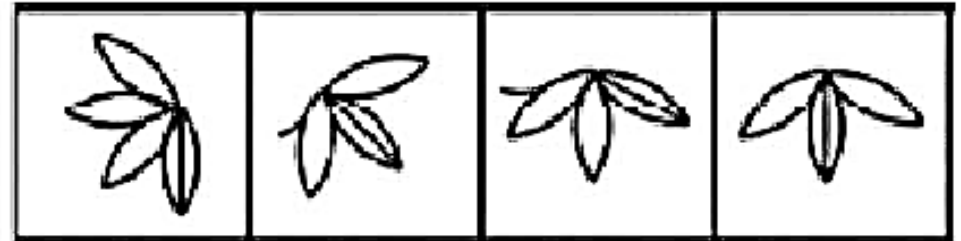

(a)

(b)

(c)

(d)

Ans: (c)

Q)

Problem Figures:

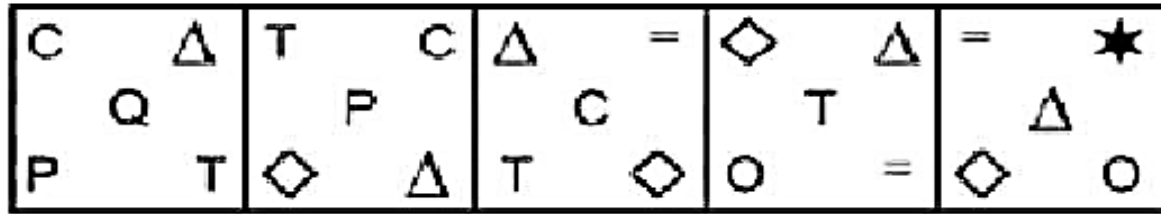

(1)

(2)

(3)

(4)

(5)

Answer Figures:

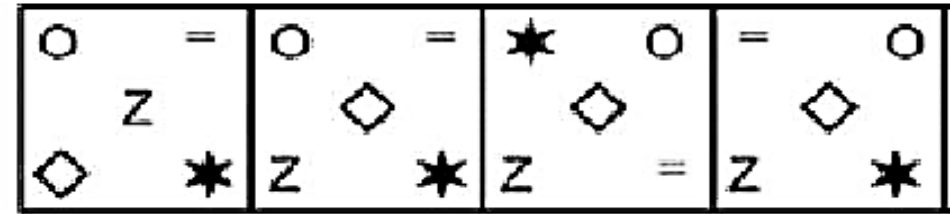

(a)

(b)

(c)

(d)

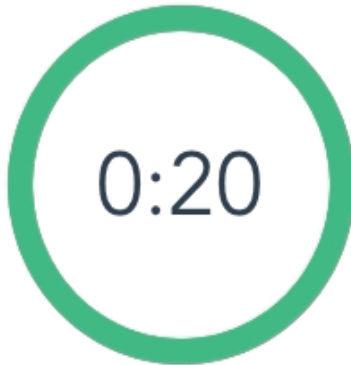

Q) Problem Figures:

C Δ	T C	Δ =	◇ Δ	= ★
Q	P	C	T	Δ
P T	◇ Δ	T ◇	O =	◇ O
(1)	(2)	(3)	(4)	(5)

Answer Figures:

O =	O =	★ O	= O
Z	◇	◇	◇
◇ ★	Z ★	Z =	Z ★
(a)	(b)	(c)	(d)

Ans: (b)

1-YEAR FULL ACCESS SSB ONLINE COURSE 2022

START YOUR SSB INTERVIEW PREPARATION TODAY WITH SSBCRACKEXAMS

HOT & NEW



5 (132 ratings) 17,552 students enrolled

Includes:

 OIR Test

 PPDT

 Psychological Tests

 Personal Interview

 Group Tasks

 Conference

 Medical

 Live Class

 Success Stories

 Personal Guidance

 SSB Trends



Q) Problem Figures:

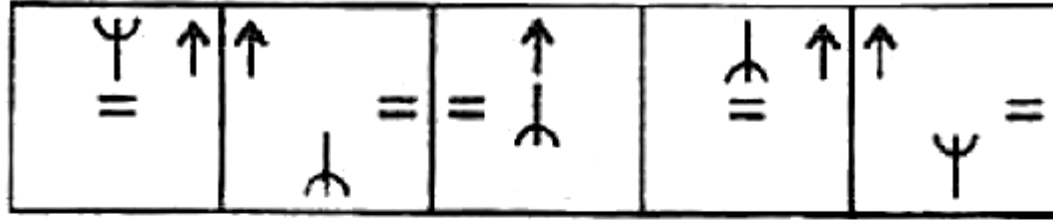

(1) (2) (3) (4) (5)

Answer Figures:

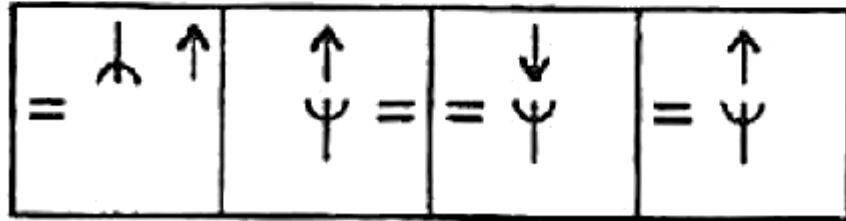

(a) (b) (c) (d)

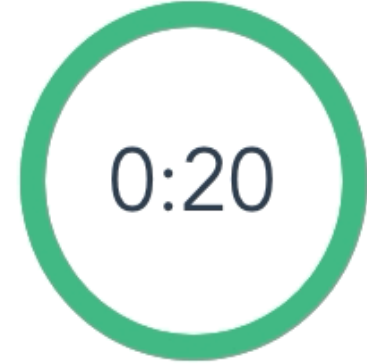

Q) Problem Figures:

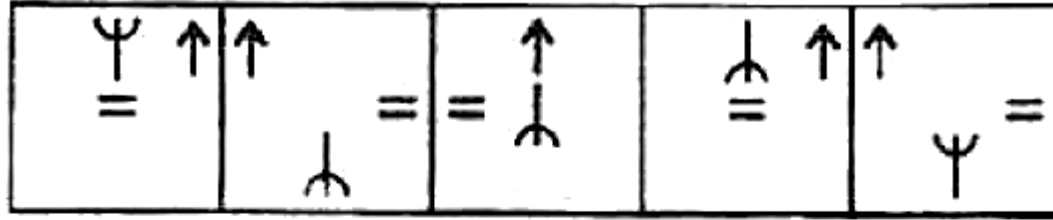

(1) (2) (3) (4) (5)

Answer Figures:

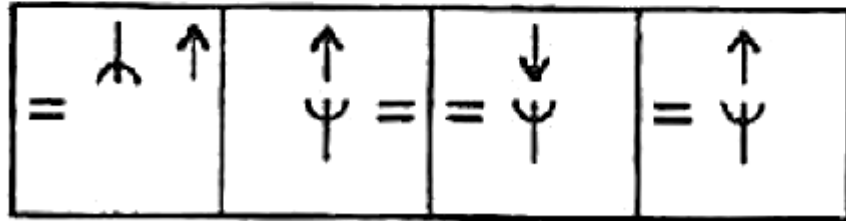

(a) (b) (c) (d)

Ans: (d)

Q) Problem Figures:

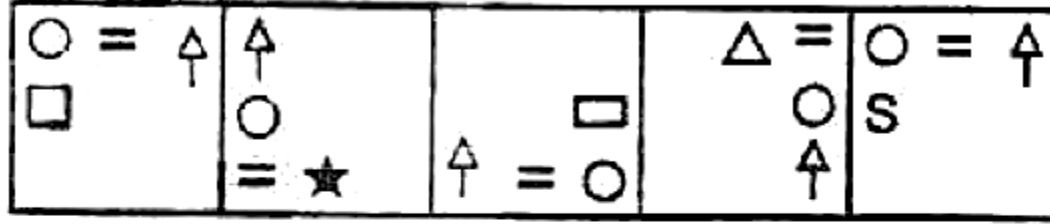

- (1) (2) (3) (4) (5)

Answer Figures:

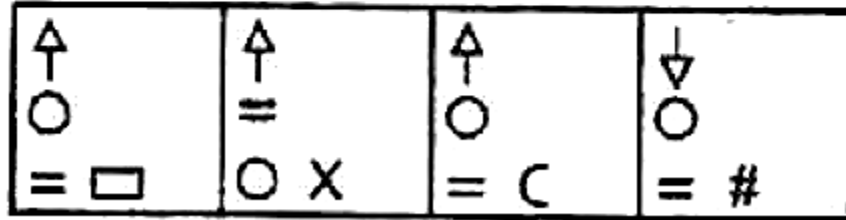

- (a) (b) (c) (d)

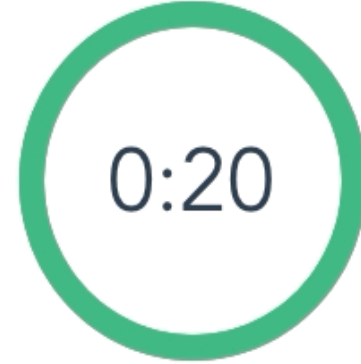

Q) Problem Figures:

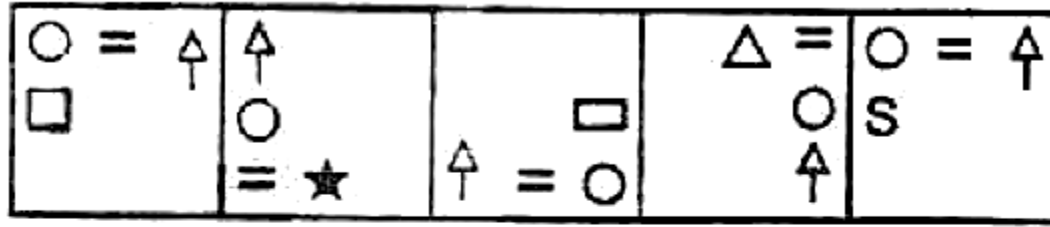

- (1) (2) (3) (4) (5)

Answer Figures:

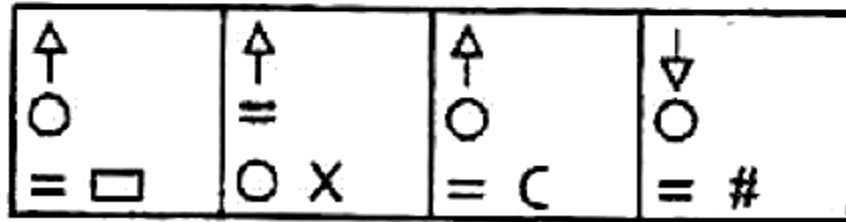

- (a) (b) (c) (d)

Ans: (b)

Q) Problem Figures:

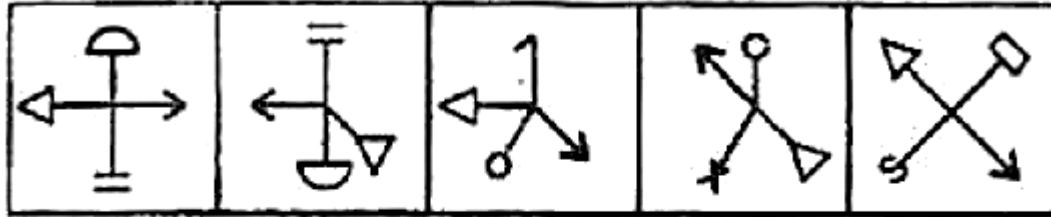

(1) (2) (3) (4) (5)

Answer Figures:

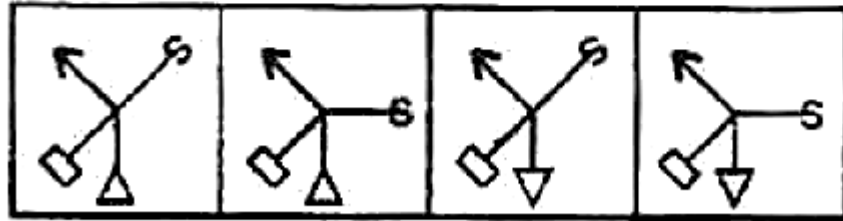

(a) (b) (c) (d)

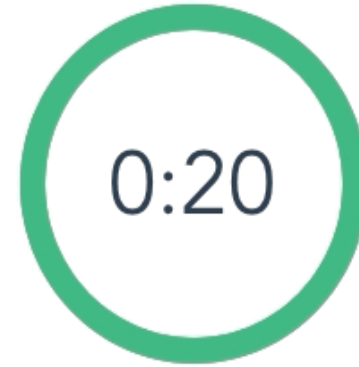

Q) Problem Figures:

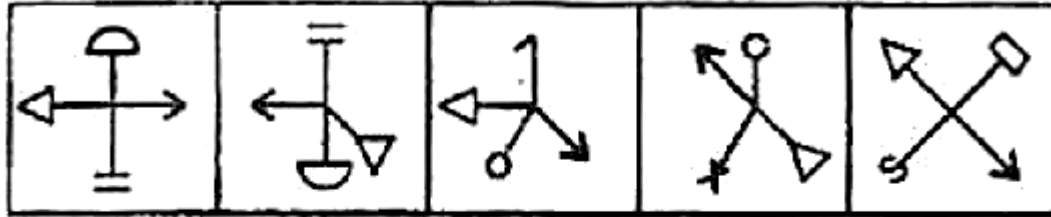

(1) (2) (3) (4) (5)

Answer Figures:

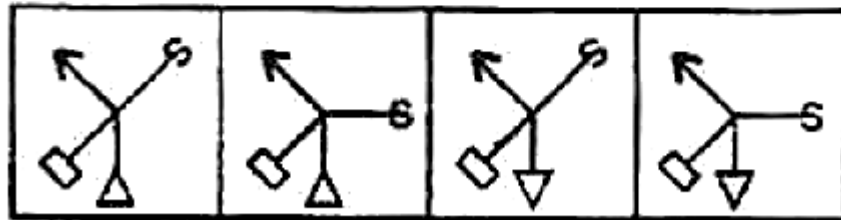

(a) (b) (c) (d)

Ans: (a)

Q) Problem Figures:

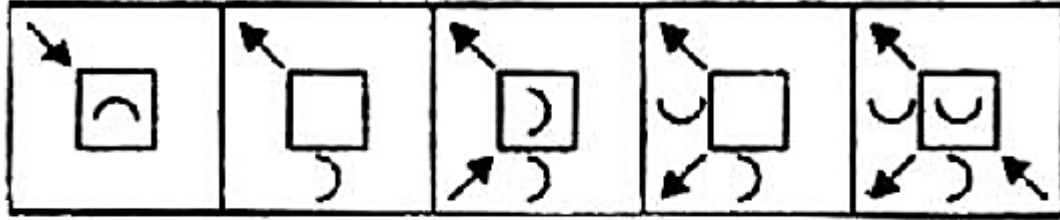

(1) (2) (3) (4) (5)

Answer Figures:

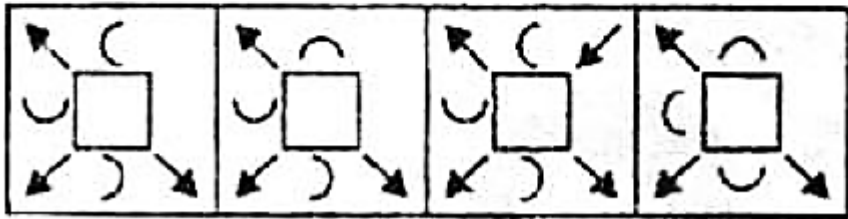

(a) (b) (c) (d)

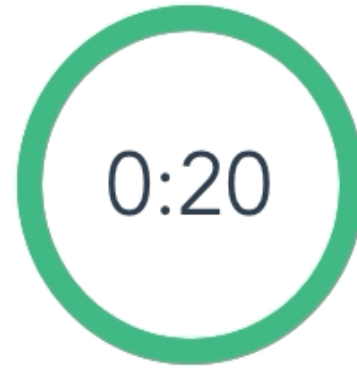

Q) Problem Figures:

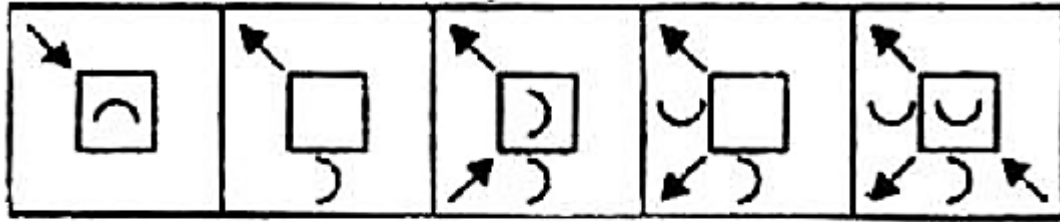

(1) (2) (3) (4) (5)

Answer Figures:

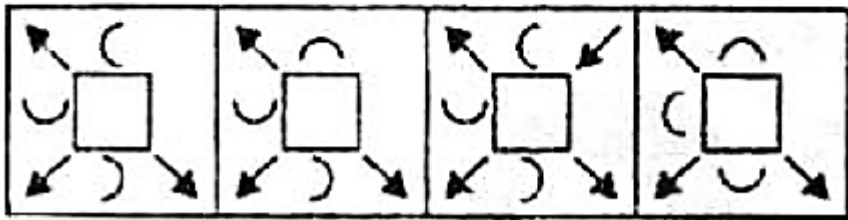

(a) (b) (c) (d)

Ans: (a)

Q) Problem Figures:

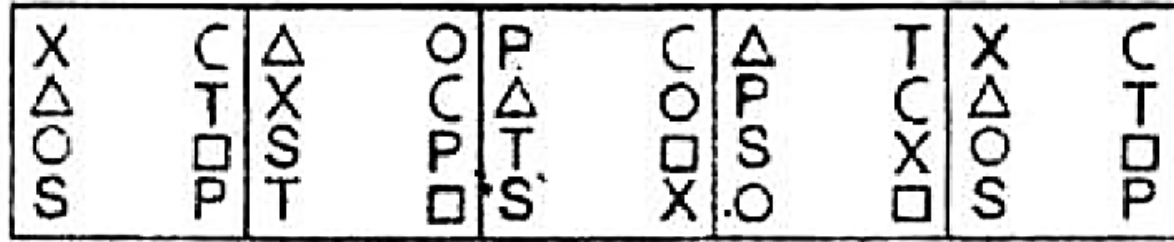

(1)

(2)

(3)

(4)

(5)

Answer Figures:

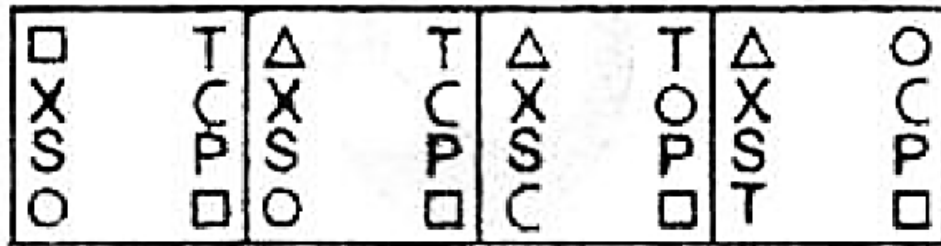

(a)

(b)

(c)

(d)

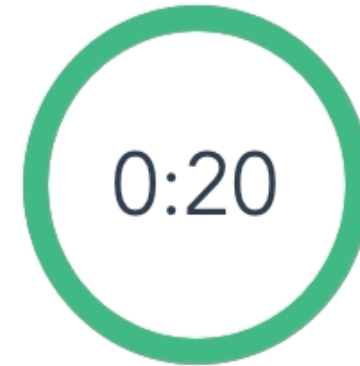

Q) Problem Figures:

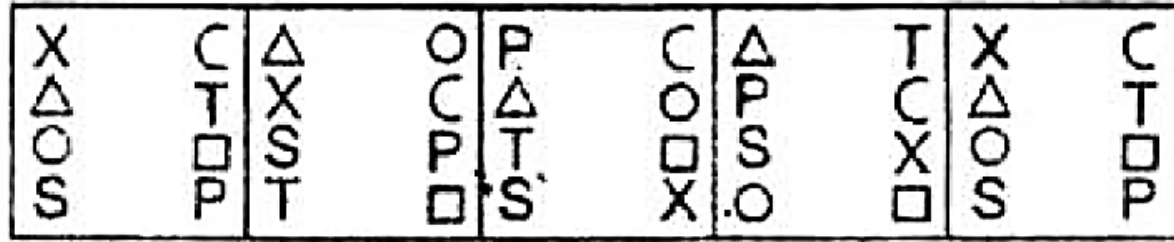

- (1) (2) (3) (4) (5)

Answer Figures:

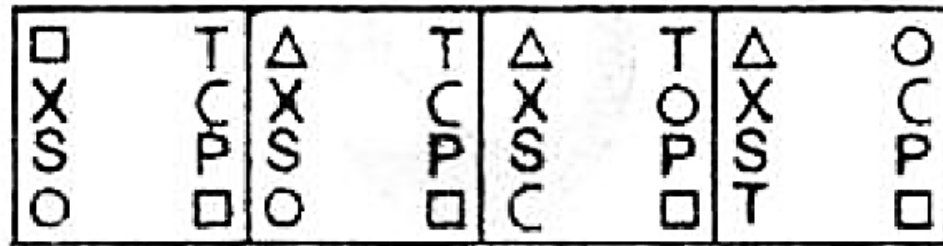

- (a) (b) (c) (d)

Ans: (d)

Q) Problem Figures:

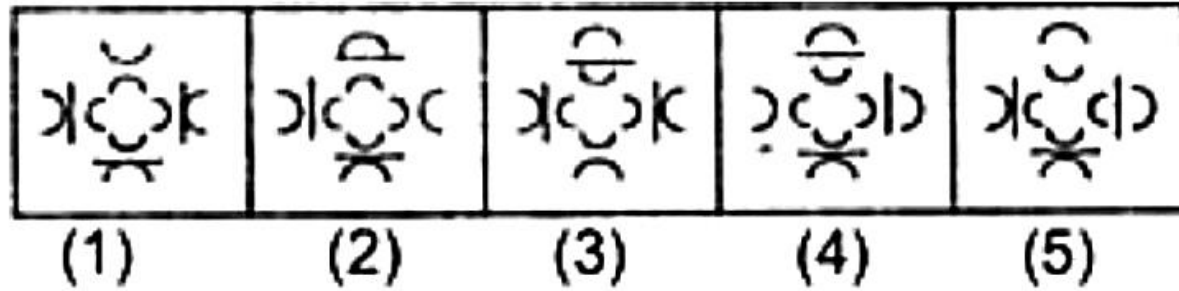

Answer Figures:

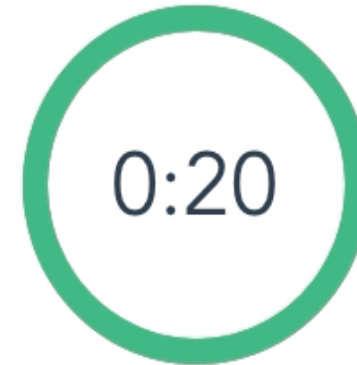
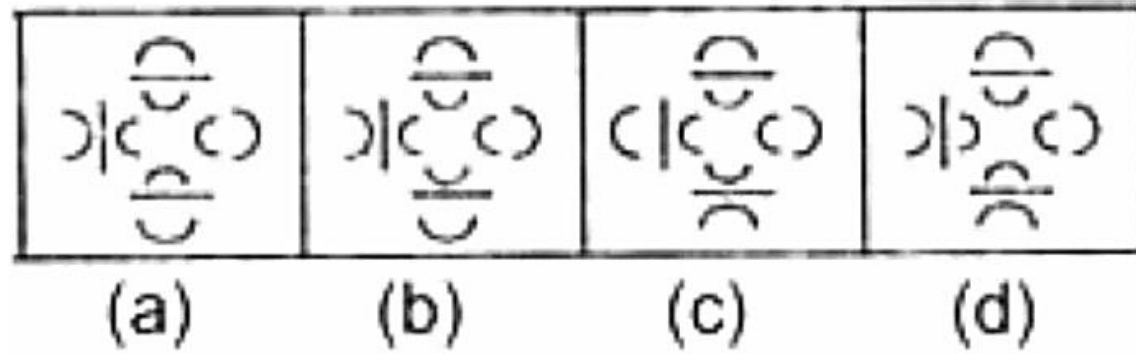

Q) Problem Figures:

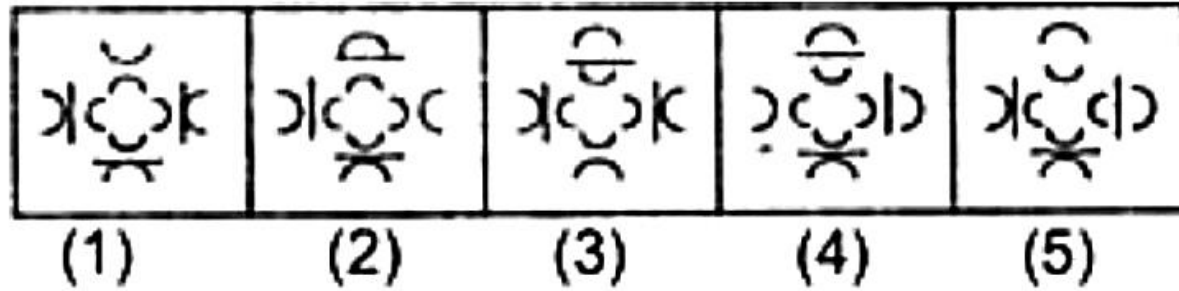

Answer Figures:

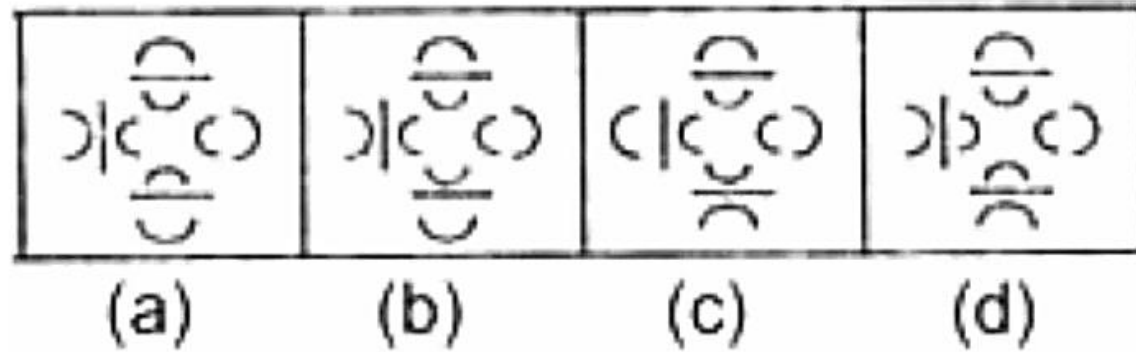

Ans: (b)

Q) Problem Figures :

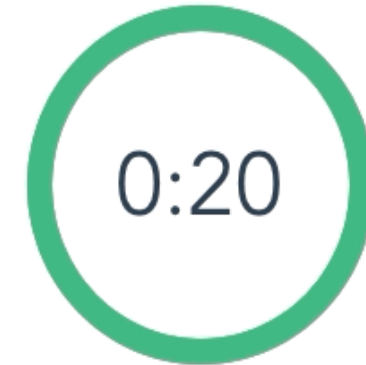
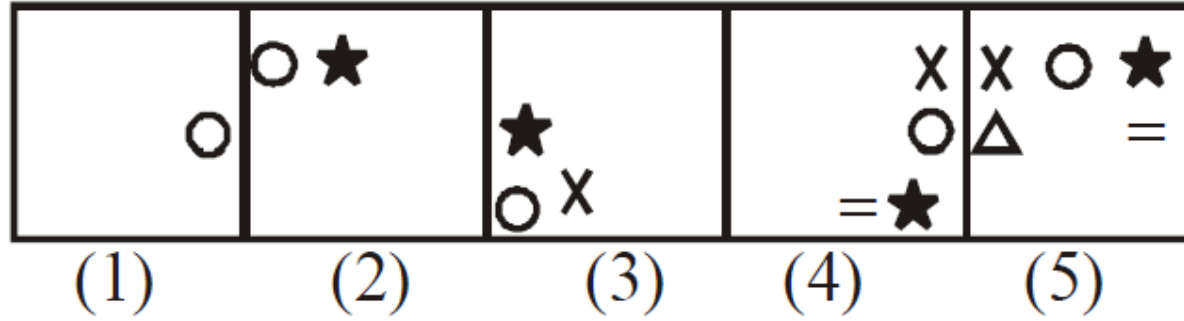

Answer Figures :

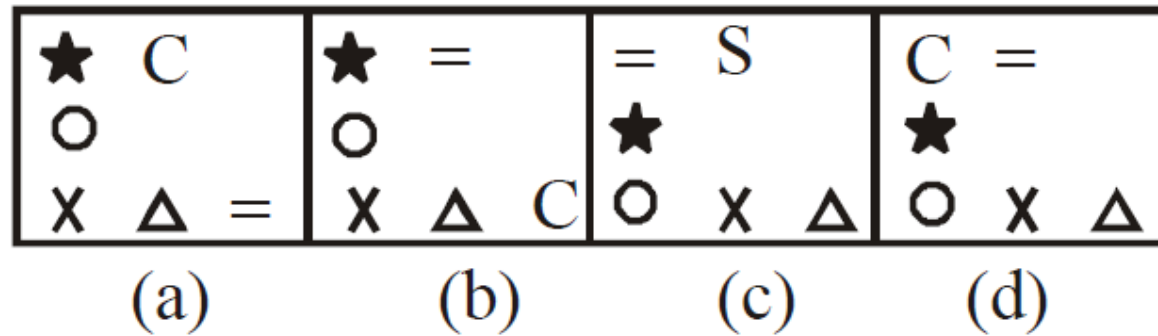

Q) Problem Figures :

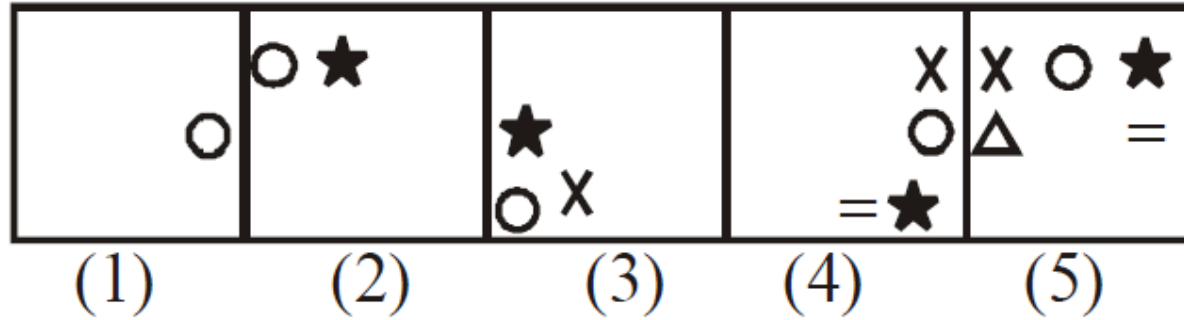

Answer Figures :

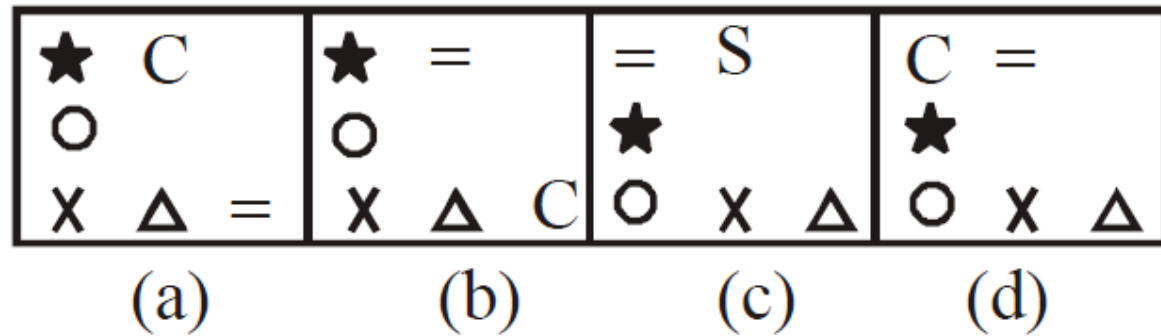

Ans: (c)

Q) **Problem Figures :**

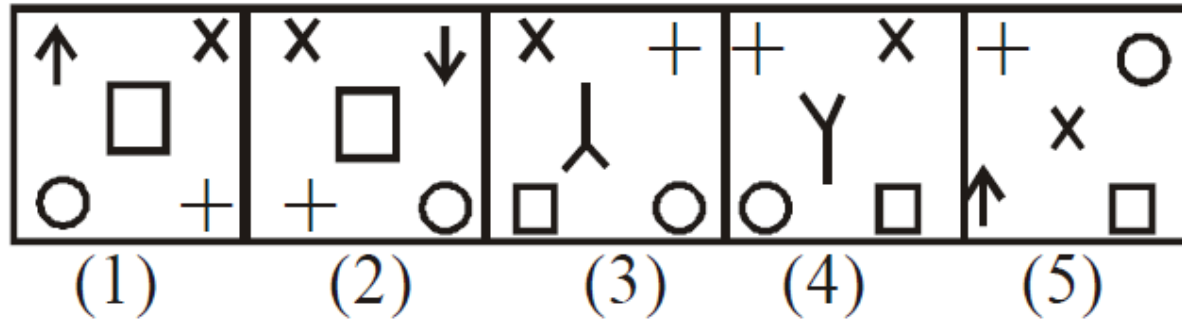

Answer Figures :

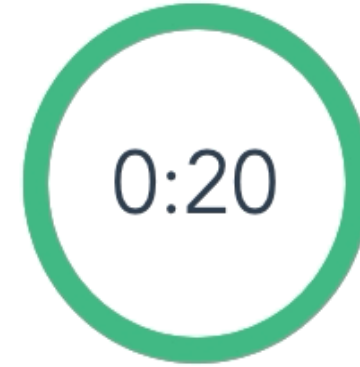
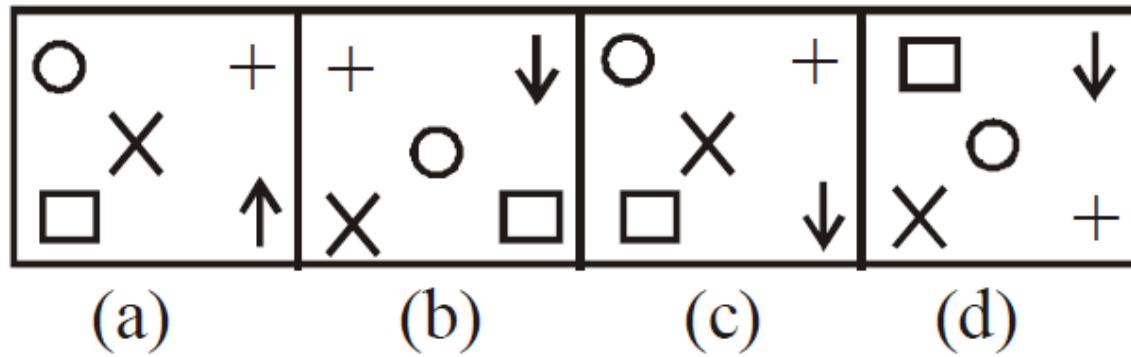

Q) Problem Figures :

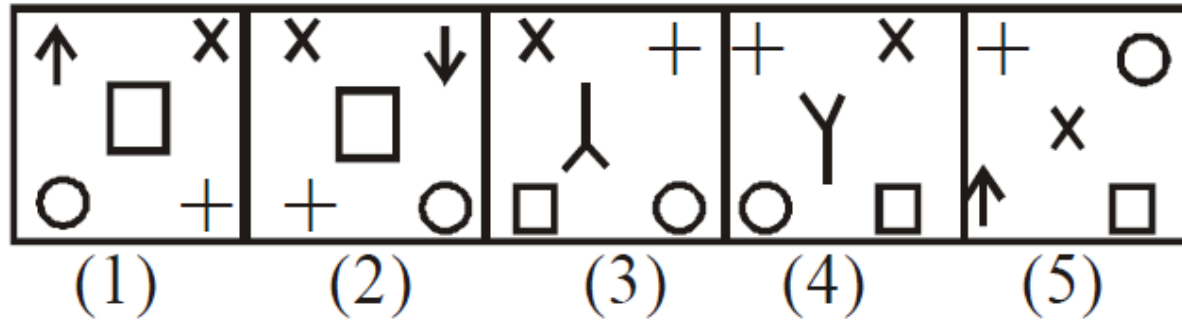

Answer Figures :

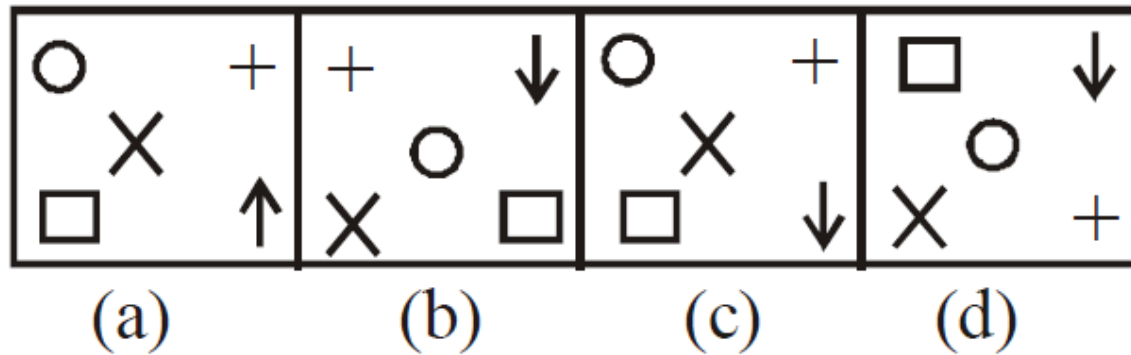

Ans: (c)

Q) Problem Figures:

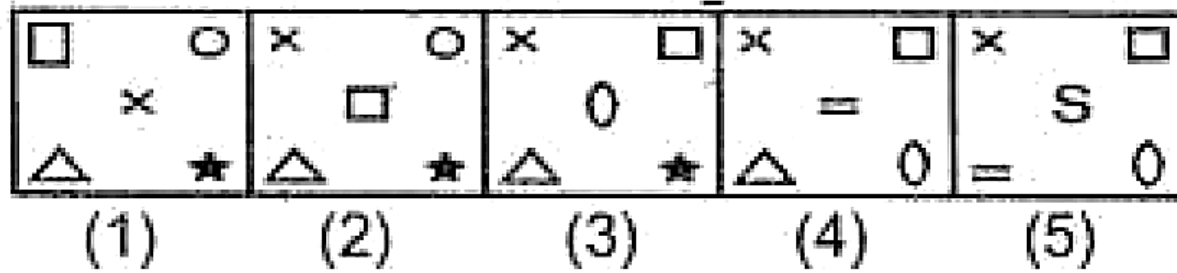

Answer Figures:

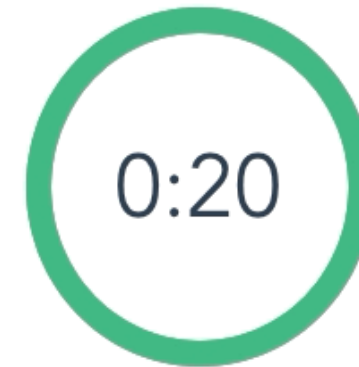
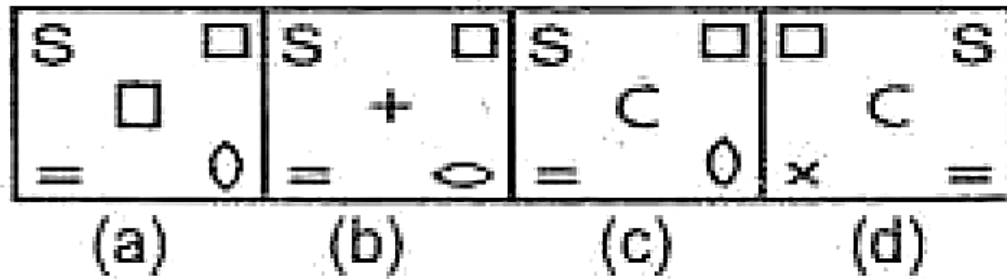

Q) Problem Figures:

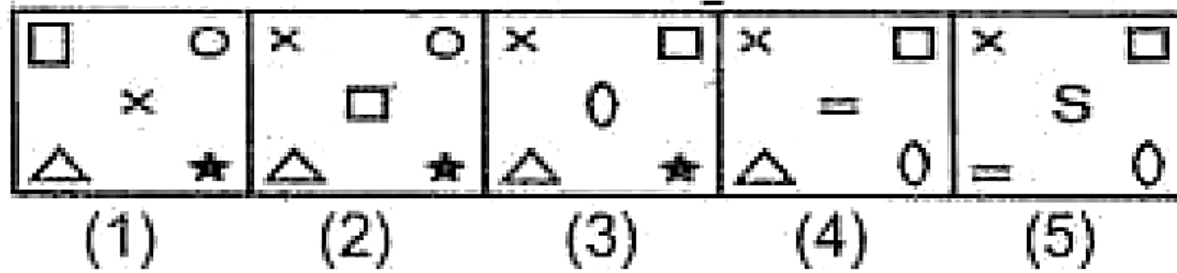

Answer Figures:

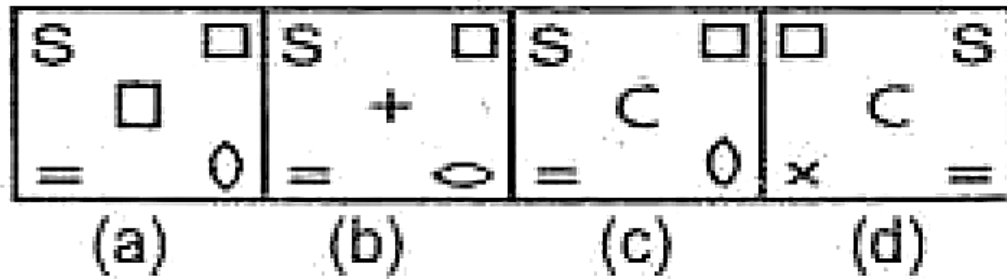

Ans: (c)

Q) Problem Figures:

Δ \circ x $S =$	Δ $= \circ$ $S x$	\circ $= S$ Δx	\circ $x =$ ΔS	x $S =$ $\Delta \circ$
(1)	(2)	(3)	(4)	(5)

Answer Figures:

S $\circ =$ Δx	x $\circ S$ $\Delta =$	\circ $x =$ ΔS	Δ $S x$ $= \circ$
(a)	(b)	(c)	(d)

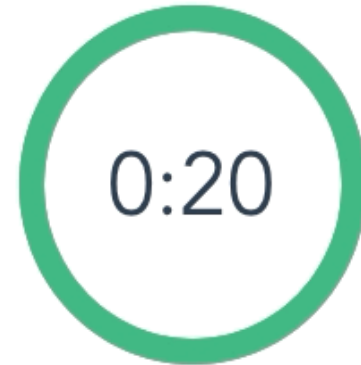

Q) Problem Figures:

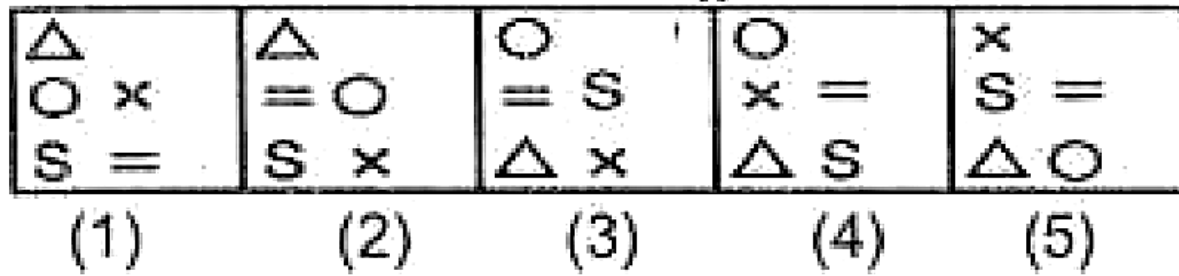

Answer Figures:

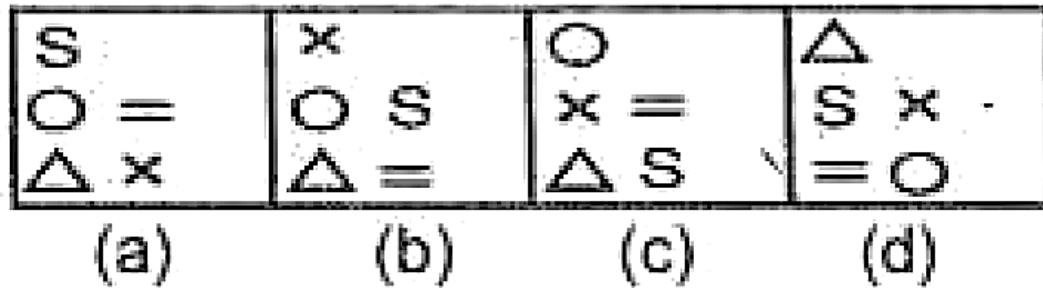

Ans: (b)

Q) Question Figure



Answer Figures



(a)



(b)



(c)



(d)

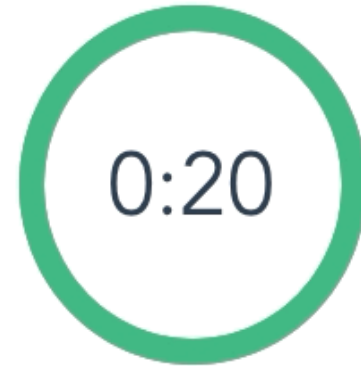

Q) Question Figure



Answer Figures



(a)



(b)



(c)



(d)

Ans: (c)

Q)

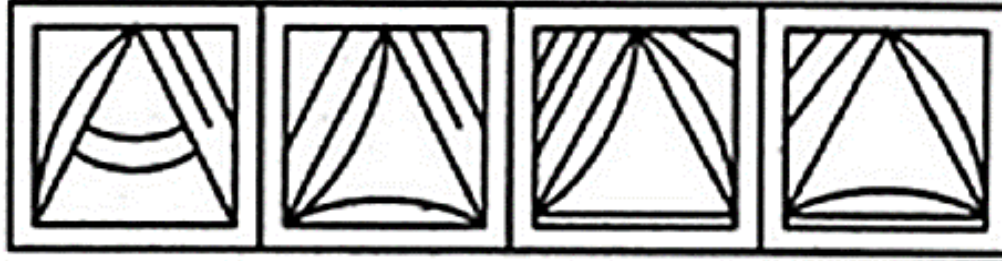

(X)

(1)

(2)

(3)

(4)

(a) 1

(b) 2

(c) 3

(d) 4

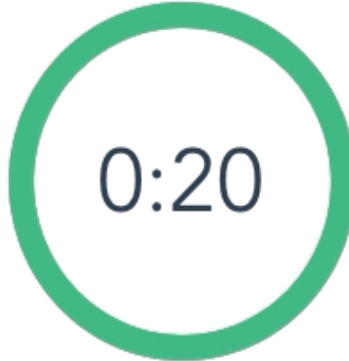

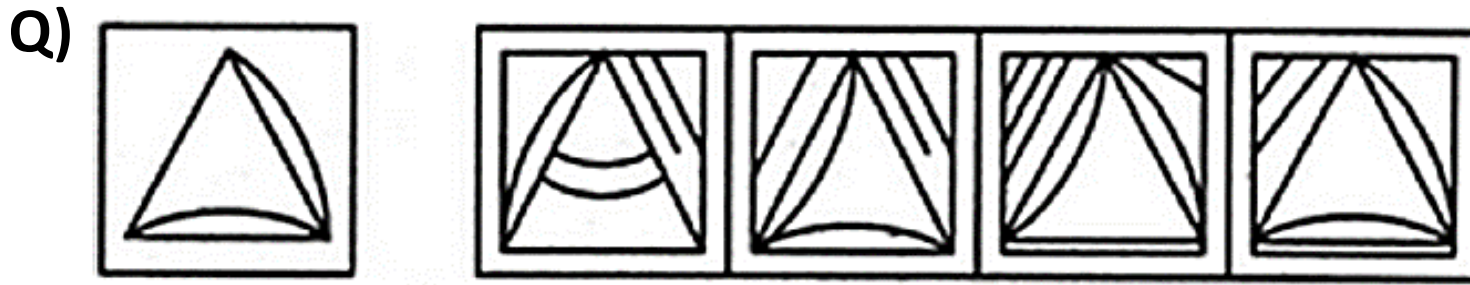

(X)

(1)

(2)

(3)

(4)

(a) 1

(b) 2

(c) 3

(d) 4

Ans: (d)

Q)

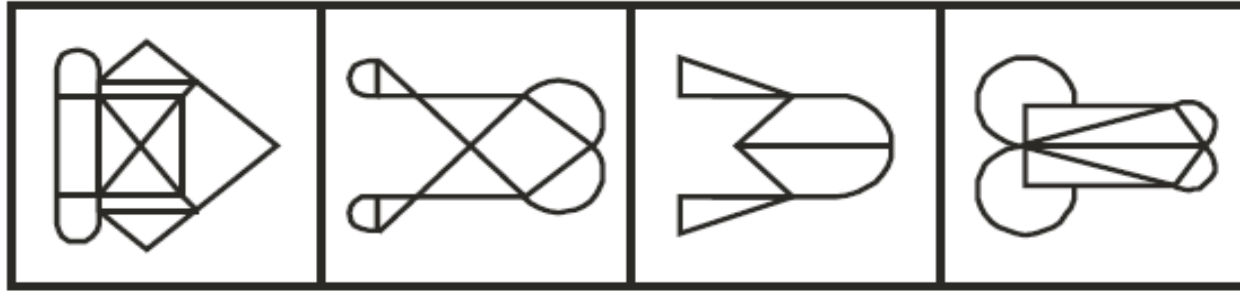
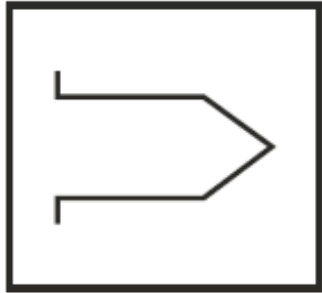

(a)

(b)

(c)

(d)

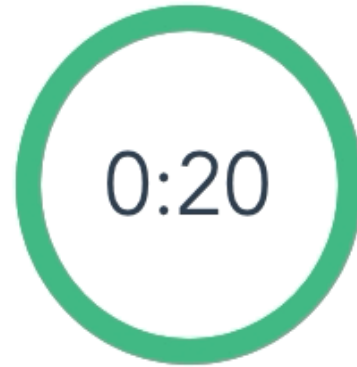

Q)

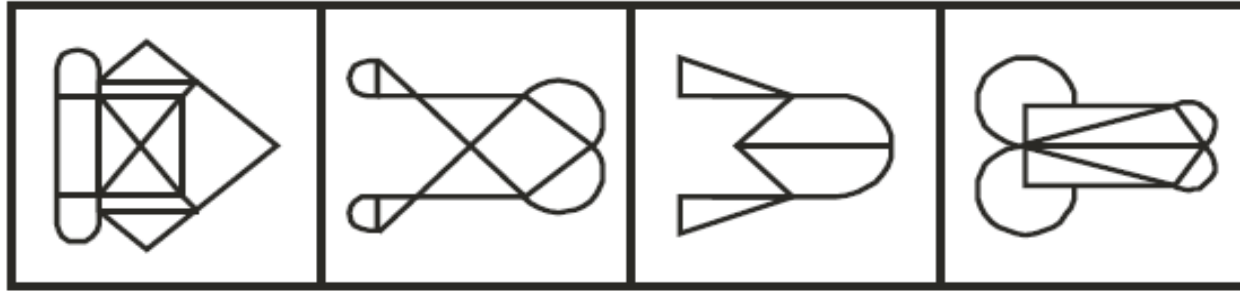
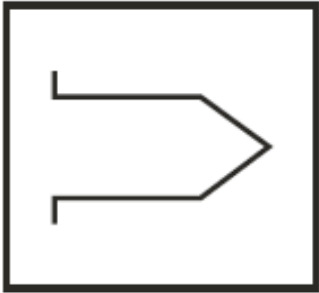

(a)

(b)

(c)

(d)

Ans: (b)

Q)

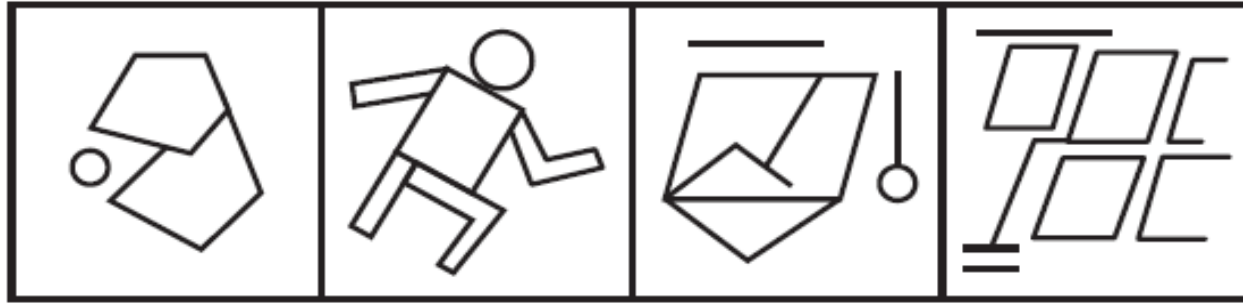

(a)

(b)

(c)

(d)

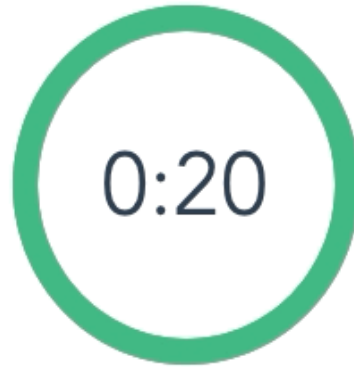

Q)

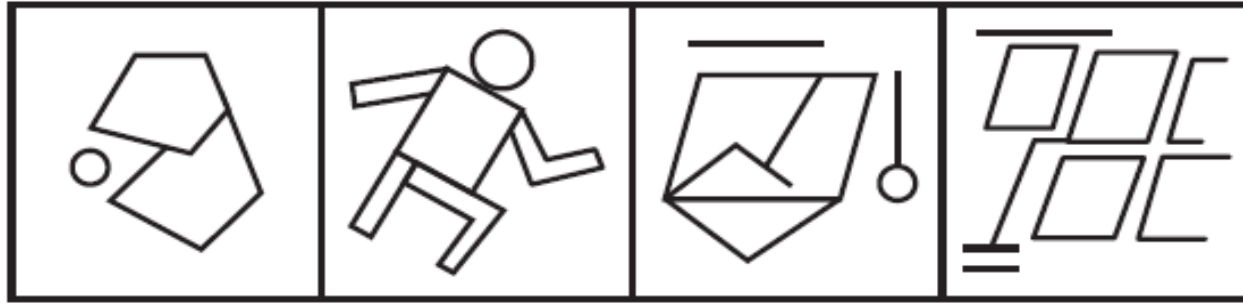

(a)

(b)

(c)

(d)

Ans: (b)

Q)

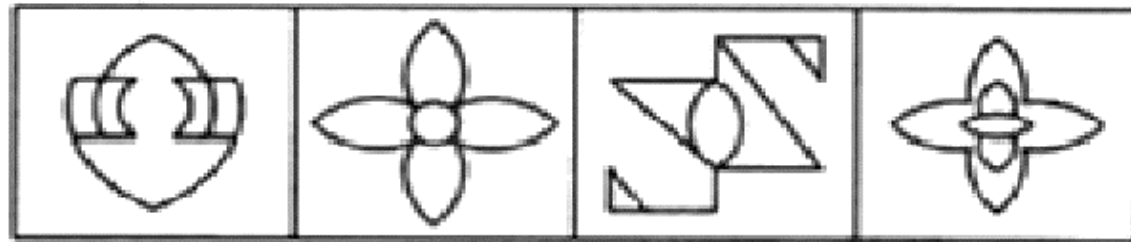
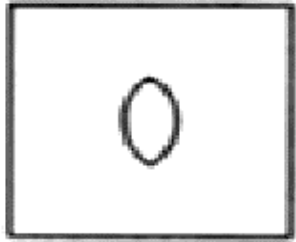

(X)

(1)

(2)

(3)

(4)

(a) 1

(b) 2

(c) 3

(d) 4

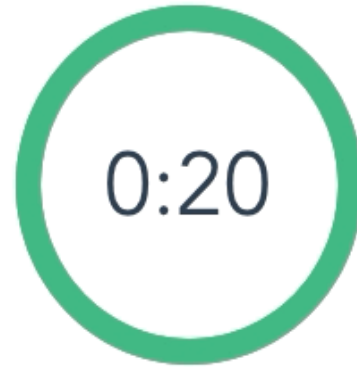

Q)

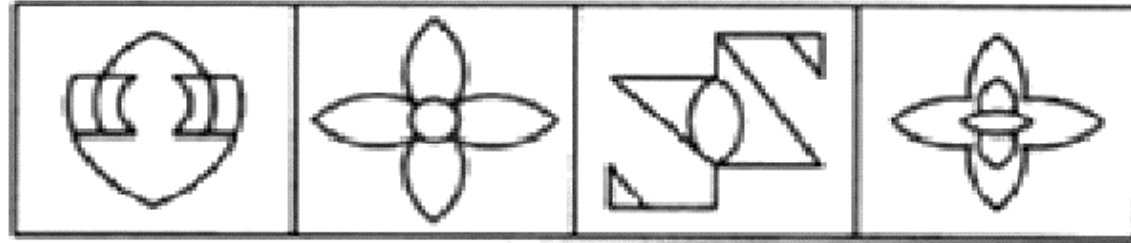
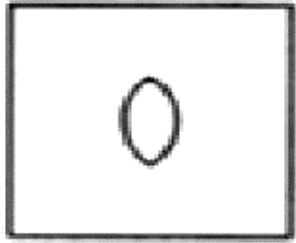

(X)

(1)

(2)

(3)

(4)

(a) 1

(b) 2

(c) 3

(d) 4

Ans: (c)

Q) Question Figure:

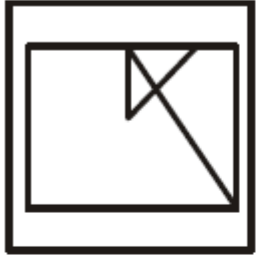

Answer Figures:

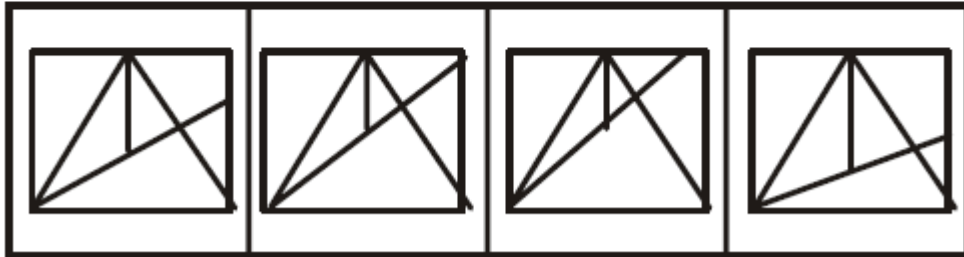

(a)

(b)

(c)

(d)

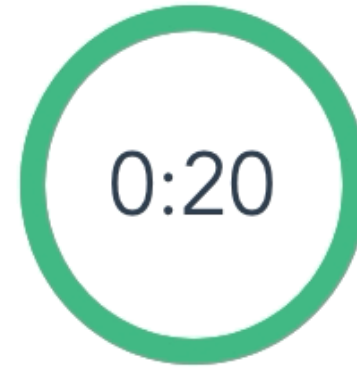

Q) Question Figure:

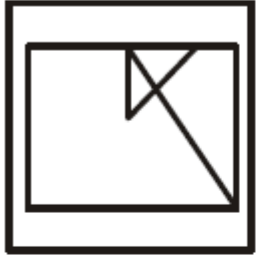

Answer Figures:

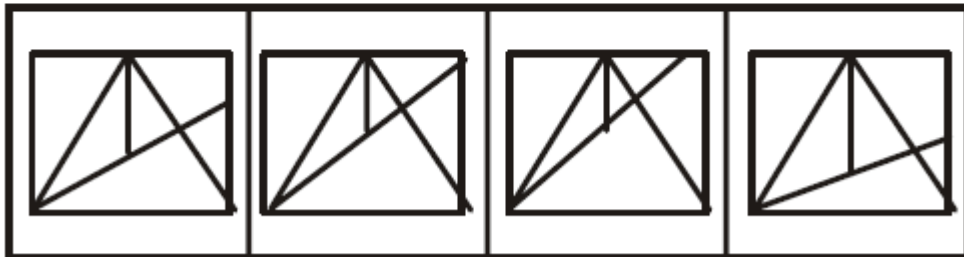

(a)

(b)

(c)

(d)

Ans: (c)

Q) Question Figure



Answer Figures

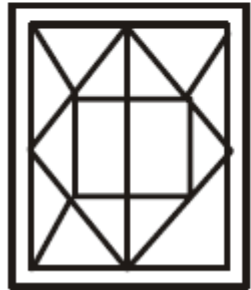

(a)



(b)

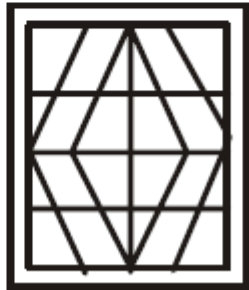

(c)

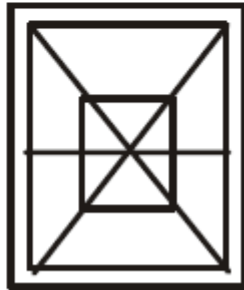

(d)

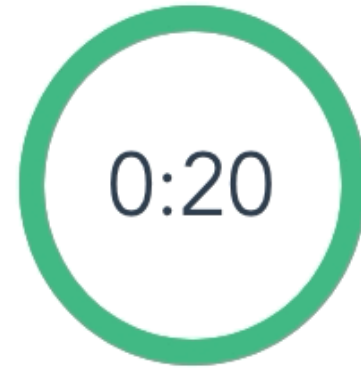

Q) Question Figure



Answer Figures

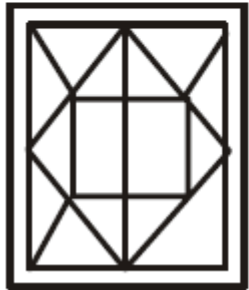

(a)



(b)

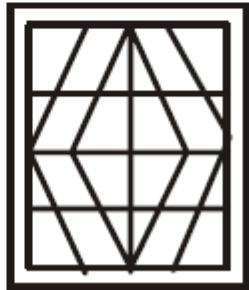

(c)

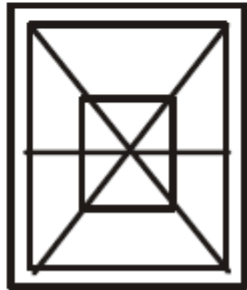

(d)

Ans: (c)

Q) Question Figure



Answer Figures

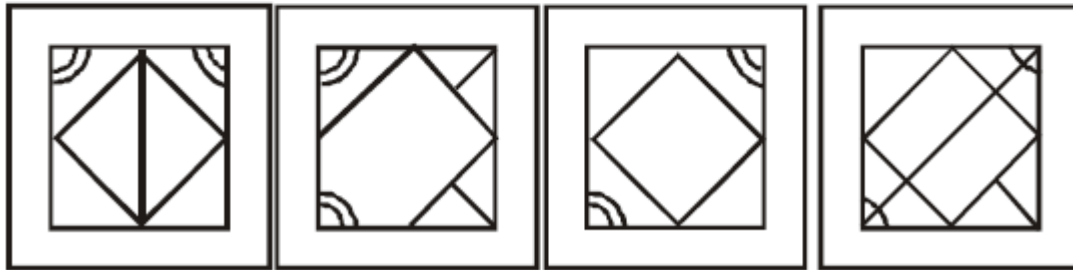

(a)

(b)

(c)

(d)

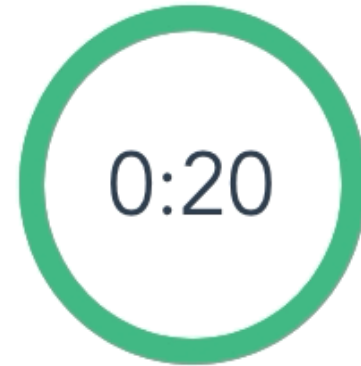

Q) Question Figure



Answer Figures

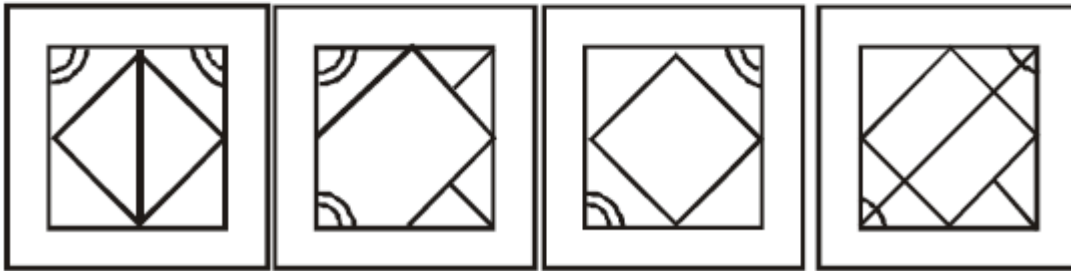

(a)

(b)

(c)

(d)

Ans: (b)

Q) Question Figure:



Answer Figures :

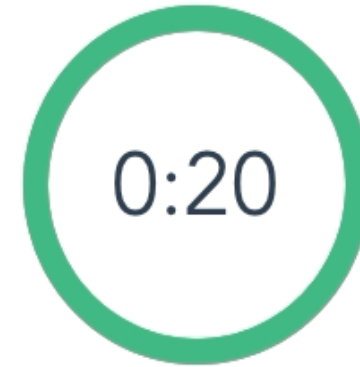
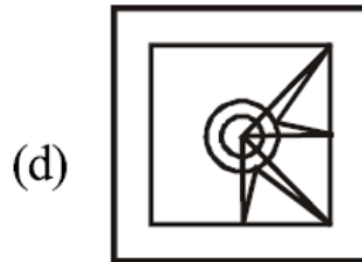
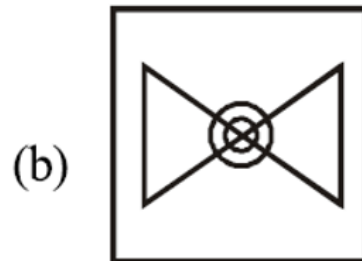
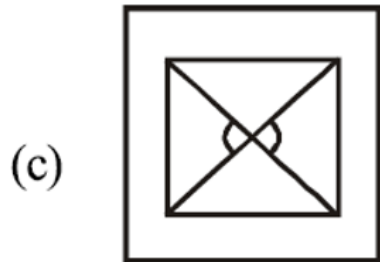
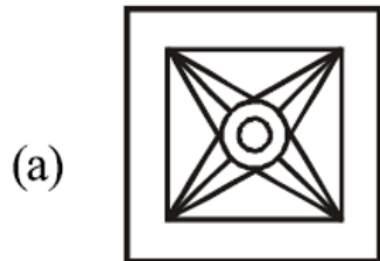

Q) Question Figure:



Answer Figures :

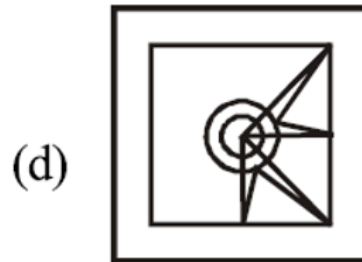
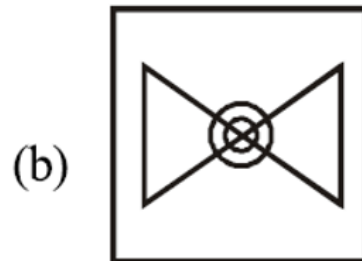
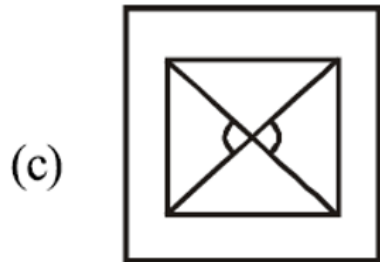
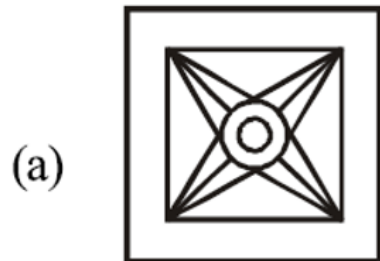

Ans: (a)

Q)

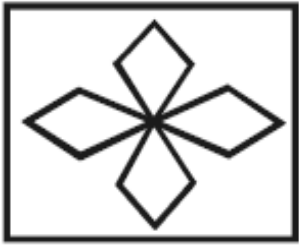

(X)

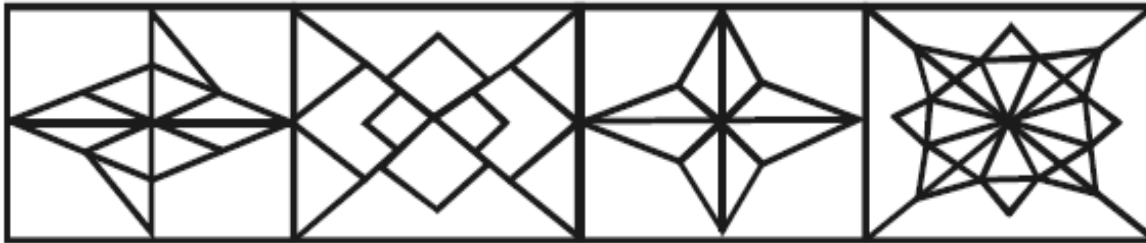

(a)

(b)

(c)

(d)

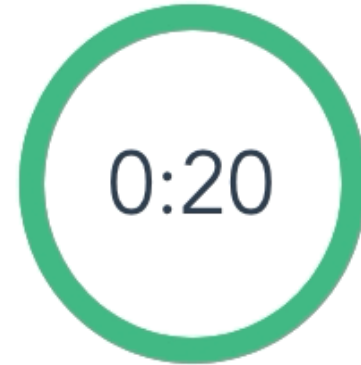

Q)

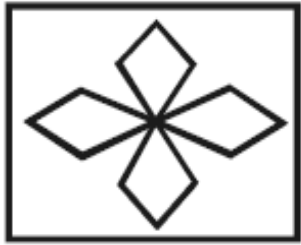

(X)

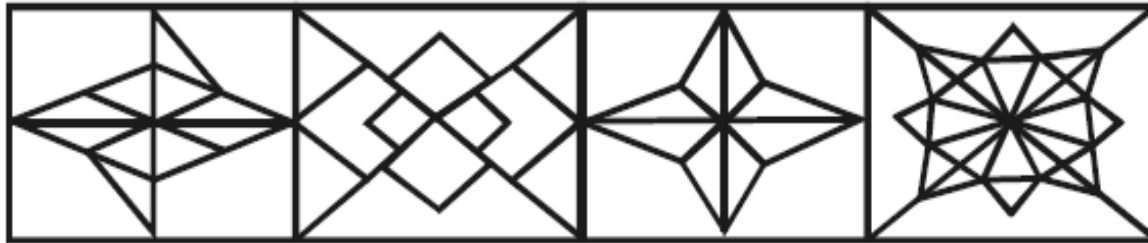

(a)

(b)

(c)

(d)

Ans: (d)

Q)

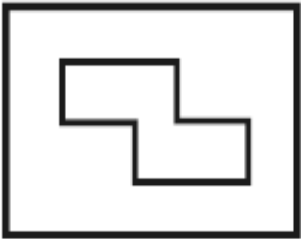

(X)



(a)

(b)

(c)

(d)

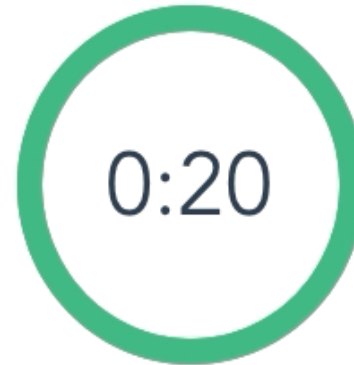

Q)

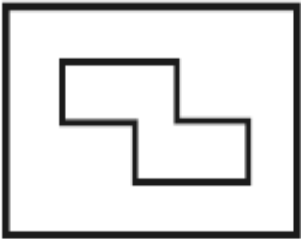

(X)



(a)

(b)

(c)

(d)

Ans: (c)

Q)



(X)

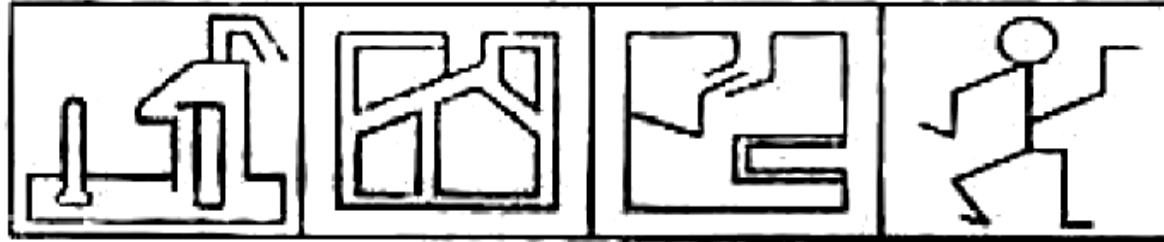

(a)

(b)

(c)

(d)

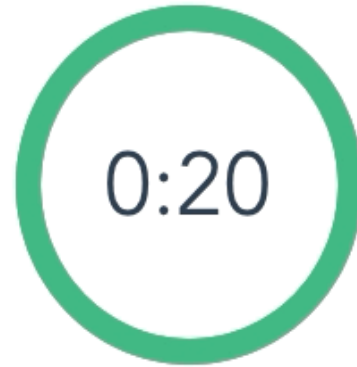

Q)



(X)

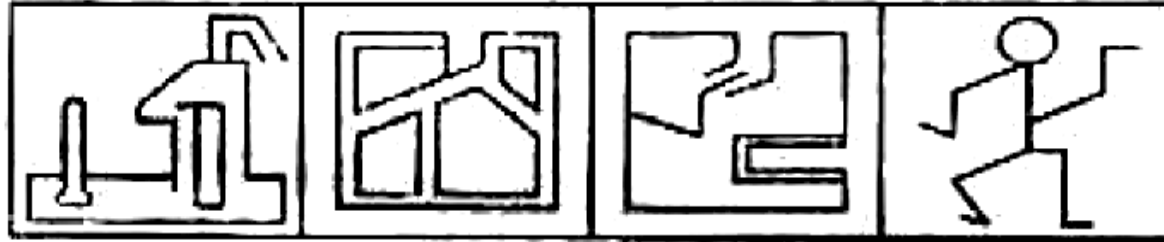

(a)

(b)

(c)

(d)

Ans: (d)

Q)



(X)

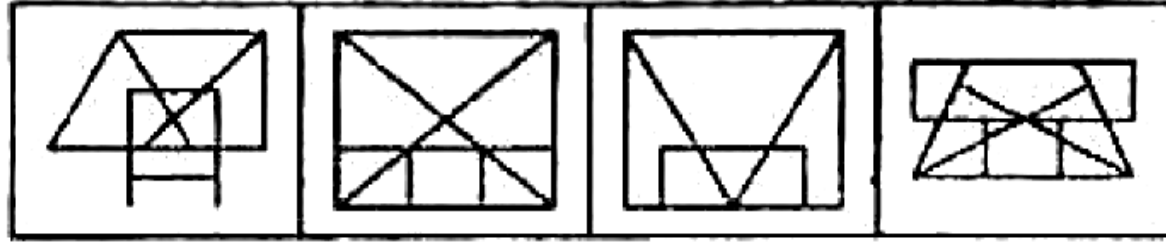

(a)

(b)

(c)

(d)

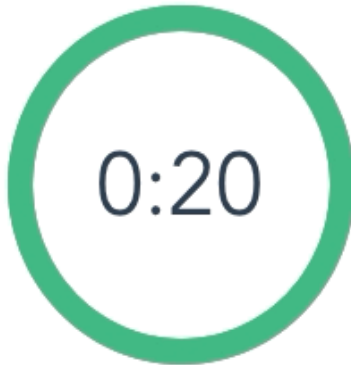

Q)



(X)

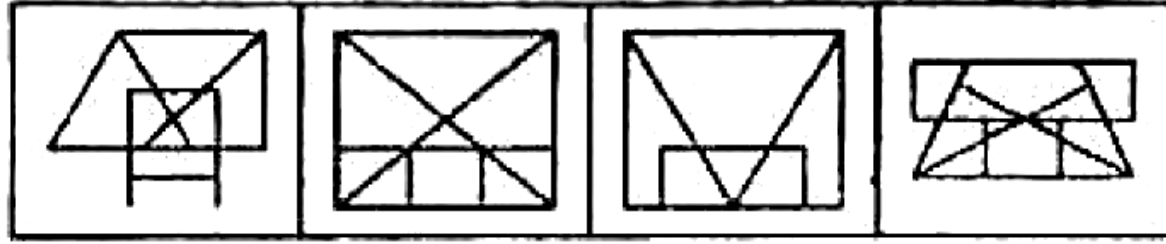

(a)

(b)

(c)

(d)

Ans: (d)

Q)

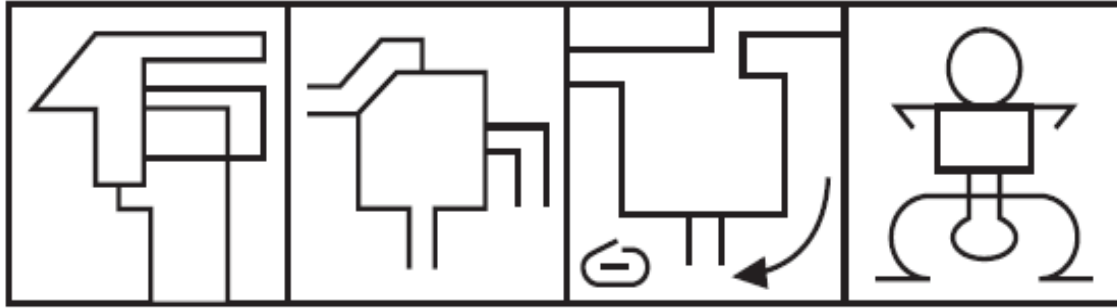
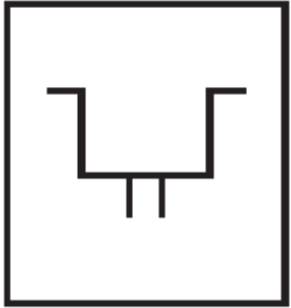

(a)

(b)

(c)

(d)

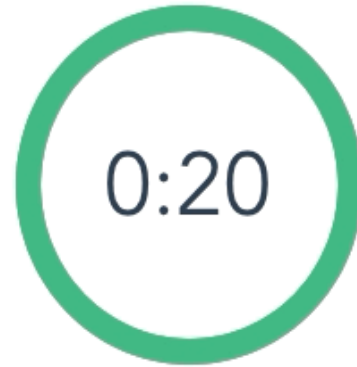

Q)

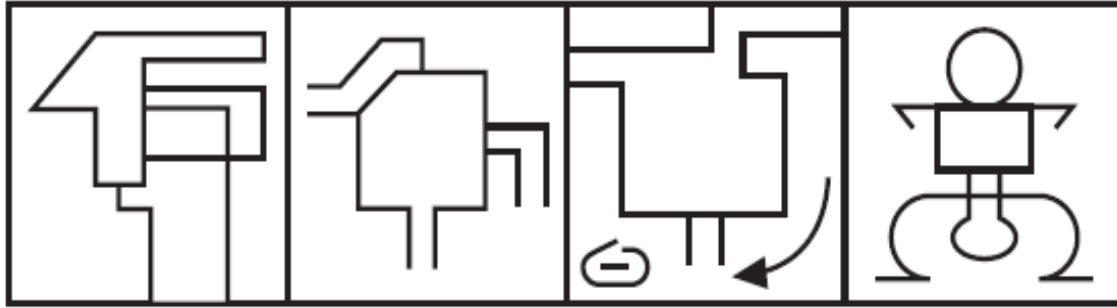
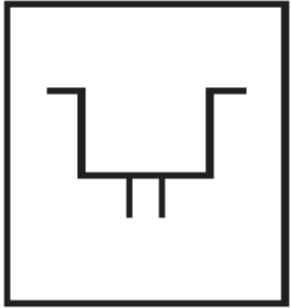

(a)

(b)

(c)

(d)

Ans: (d)

AFCAT Exam Online Course 2022 – 2023

Start your AFCAT Exam preparation today with SSB Crack Exams.

★★★★★ 5.0 (114)

Content 24

Search in bundle



FILTER BY TYPE



AFCAT 2 2022 Exam Overview

Course • 27 Lessons



Success Stories

Course • 39 Lessons



AFCAT 2 2022 Study Plan And Analysis

Course • 24 Lessons



Notifications & Exam Dates

Course • 182 Lessons



90 Days validity

[Change Validity](#)

₹3,999 ~~₹4,999~~ 20% OFF

BUY BUNDLE

START A FREE TRIAL

What's included

24 Courses

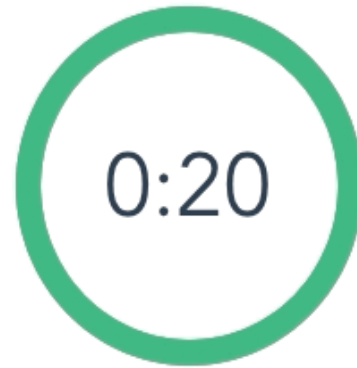
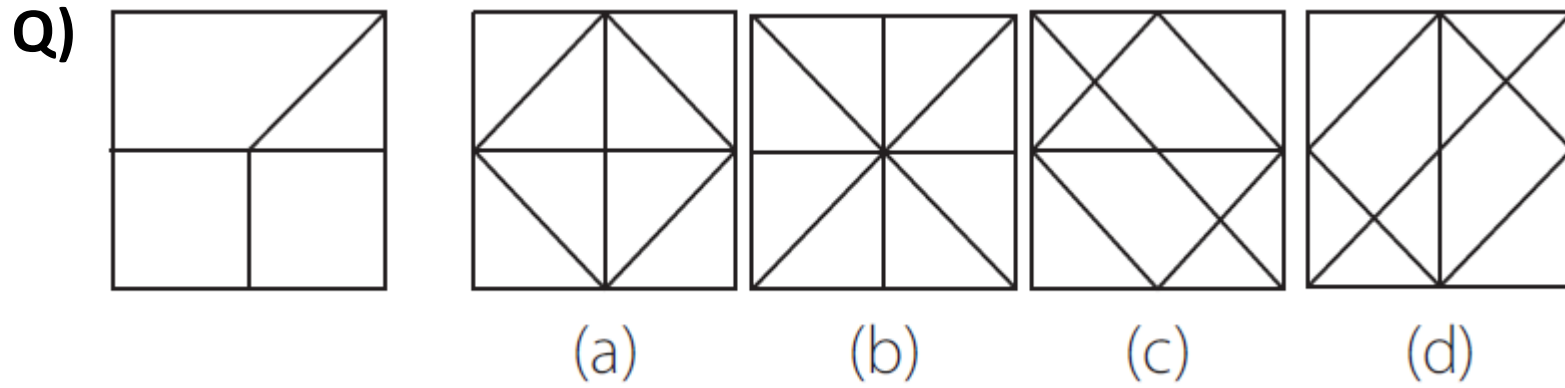

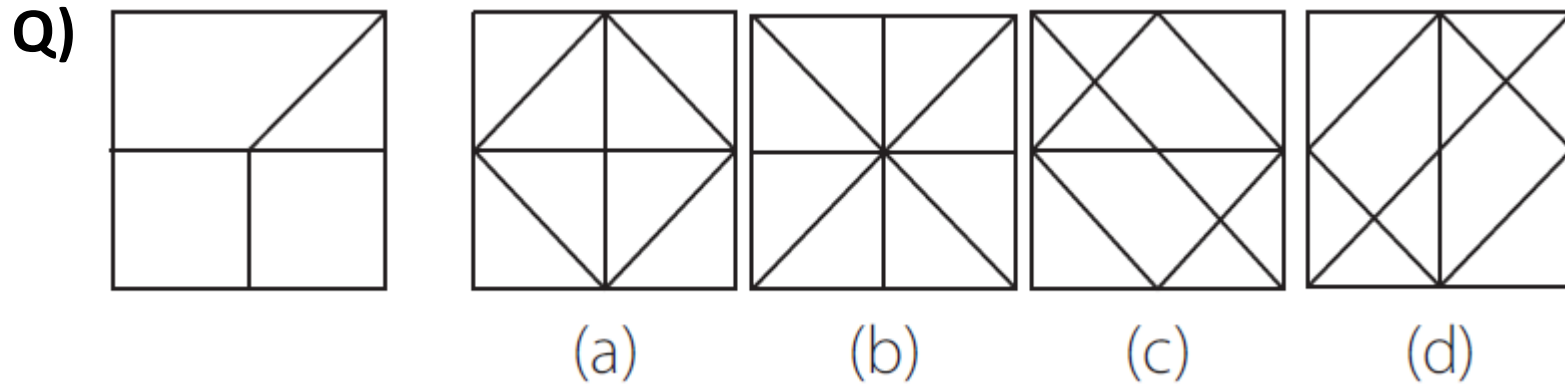

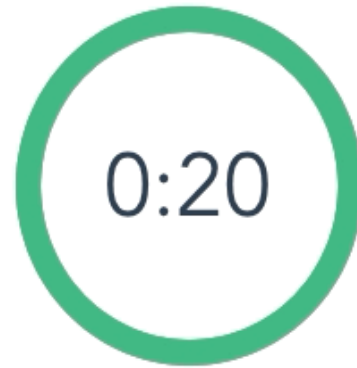
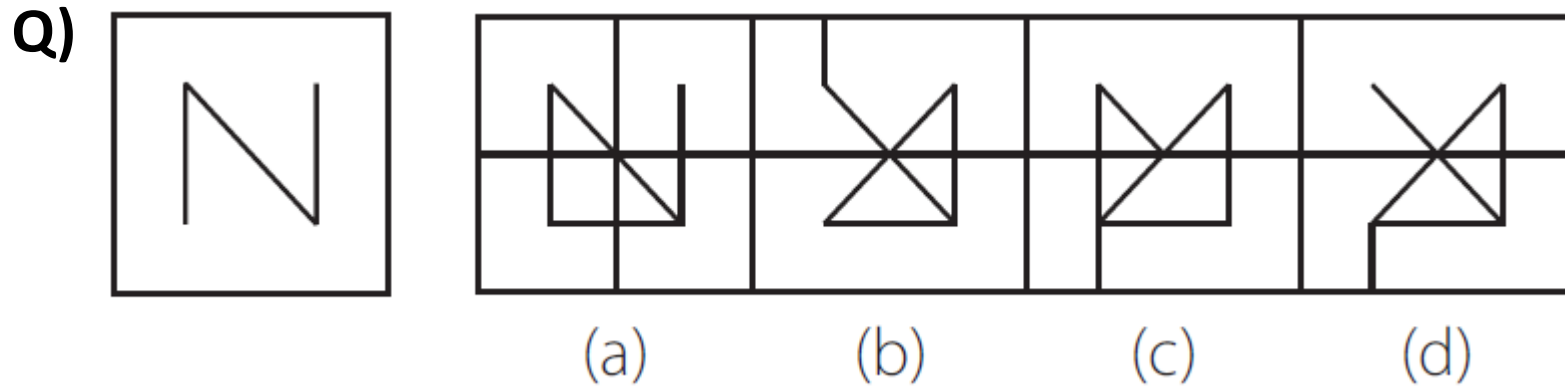

Ans: (b)

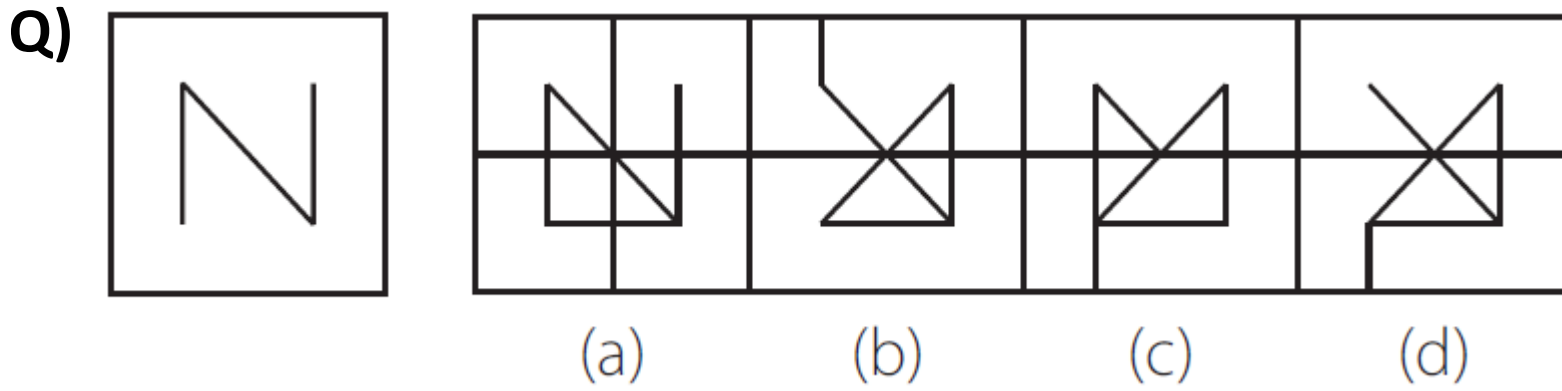

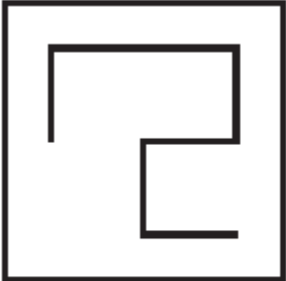

Ans: (a)

Q) 

(a) 

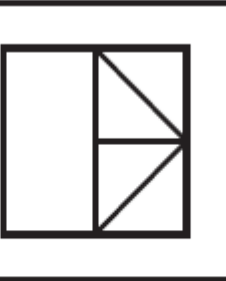
(b) 

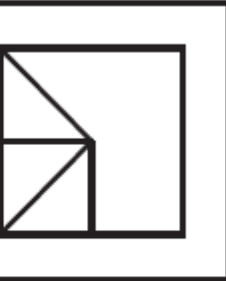
(c) 

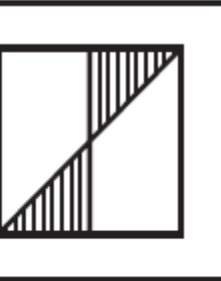
(d) 



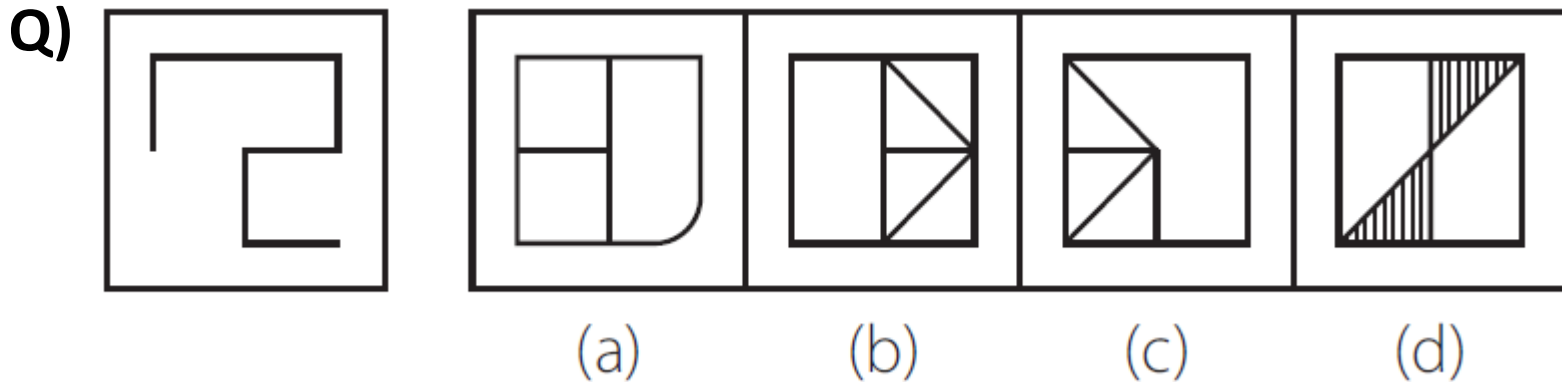

Ans: (b)

Q)

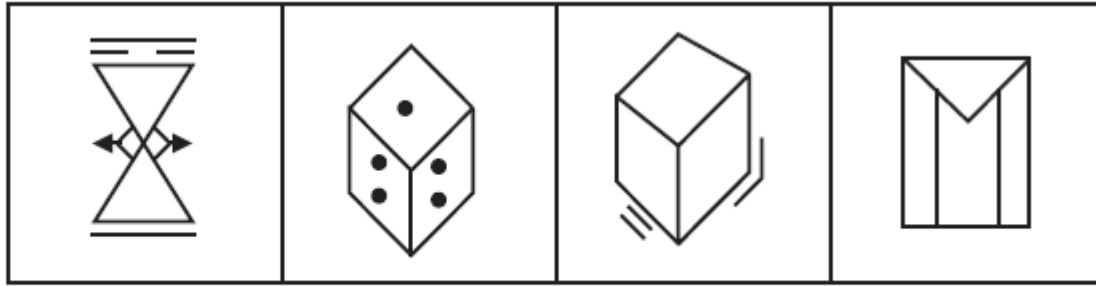
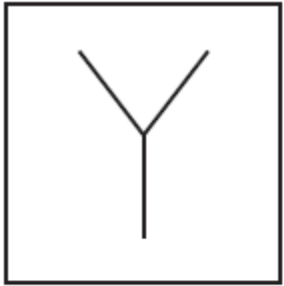



(a)

(b)

(c)

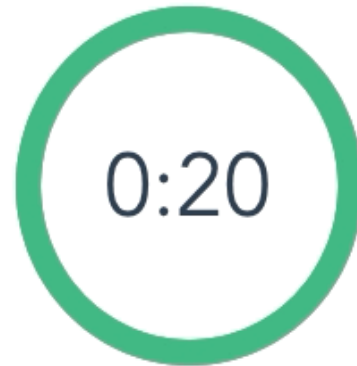
(d)



Q) 

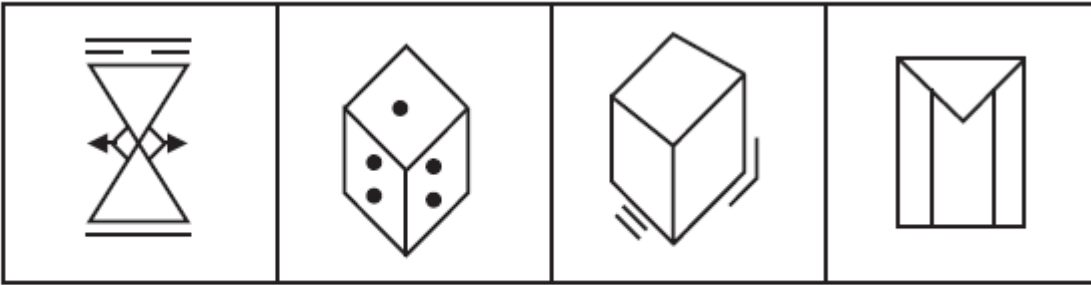

(a) (b) (c) (d)

Ans: (b)

Q)

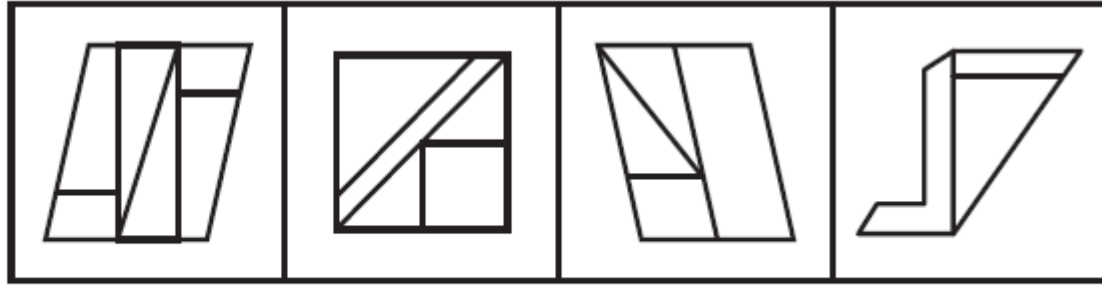

(a)

(b)

(c)

(d)

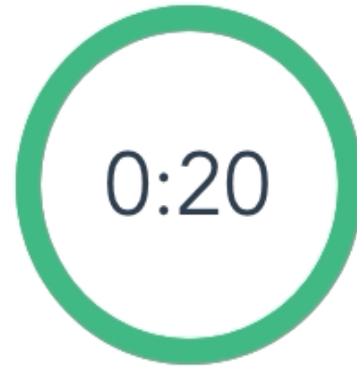

Q)

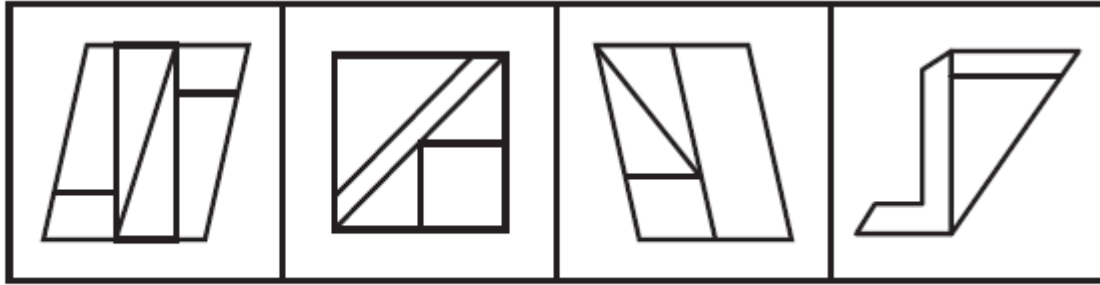

(a)

(b)

(c)

(d)

Ans: (d)

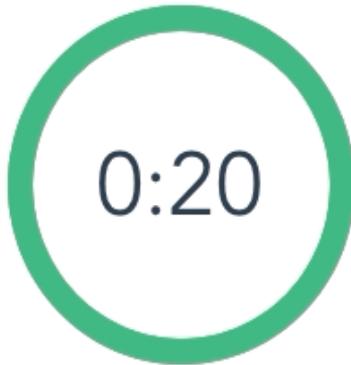
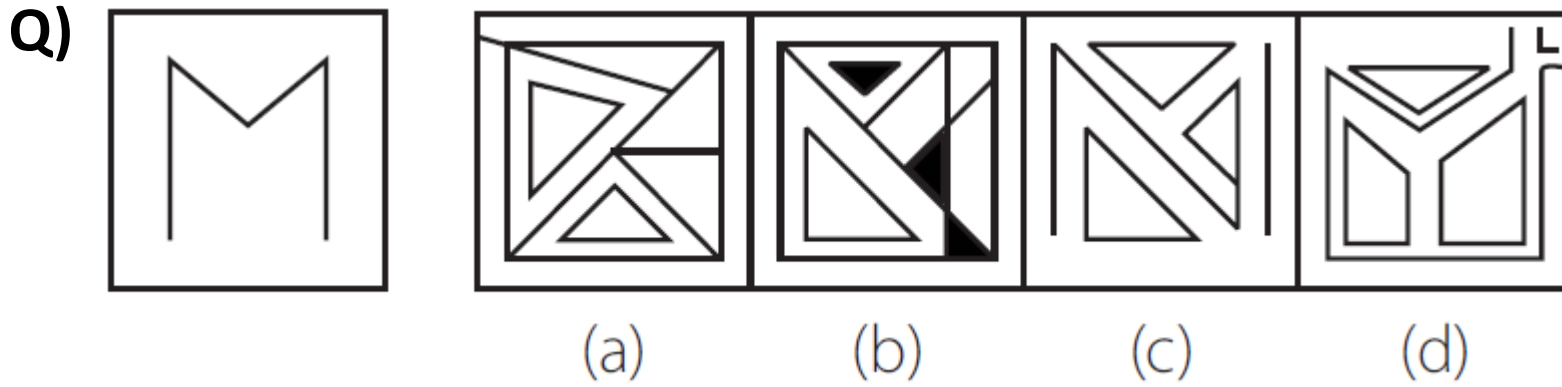

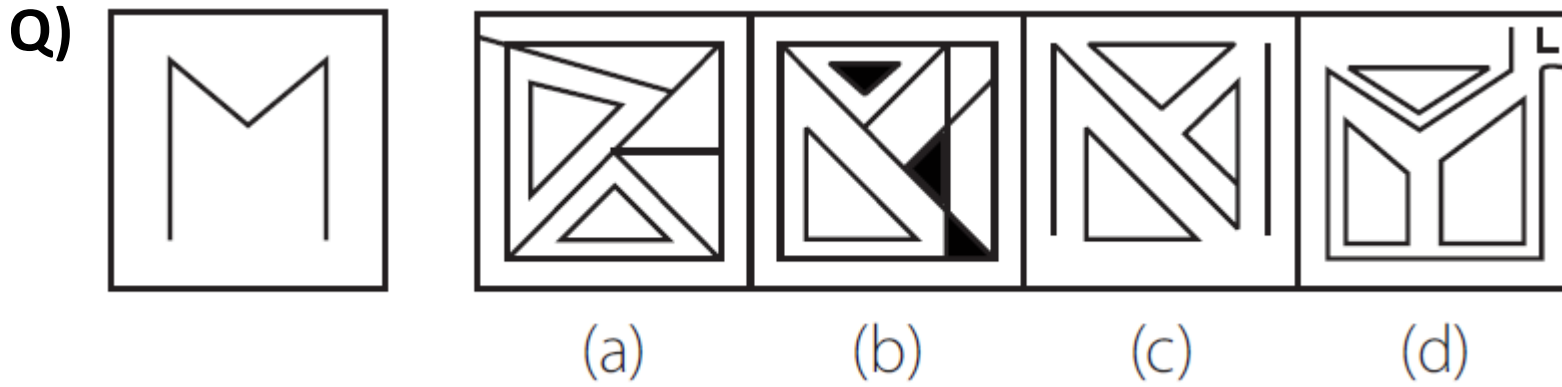

Ans: (b)

Q) 

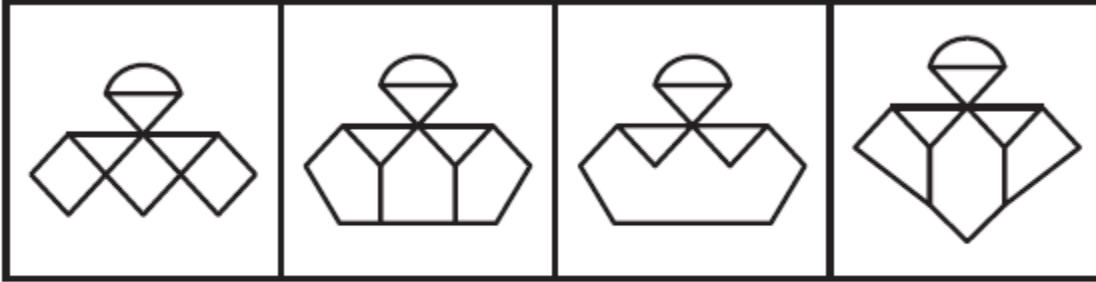

(a) (b) (c) (d)

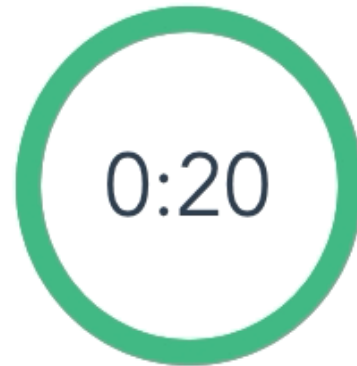

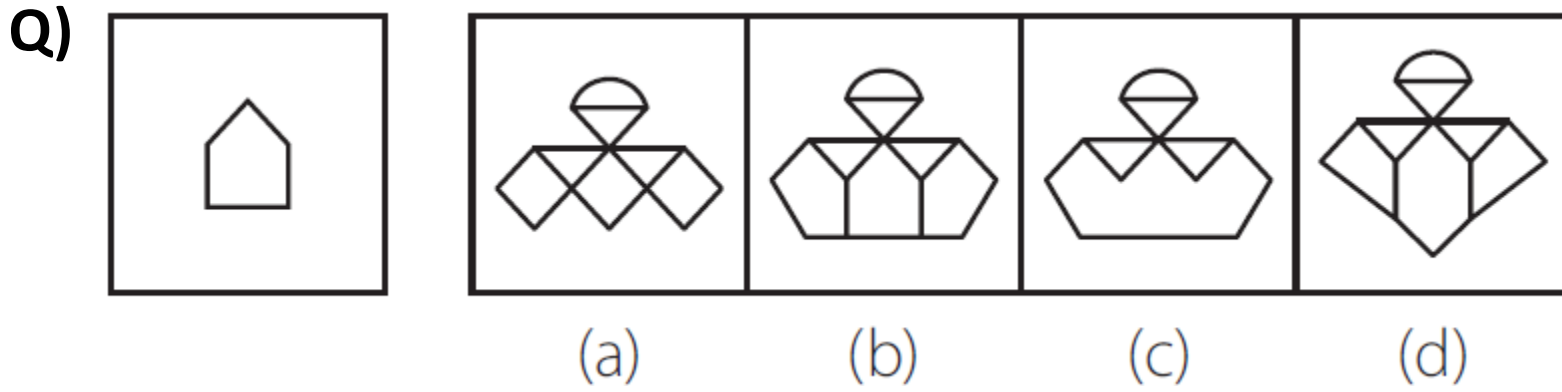

Ans: (b)

Q)

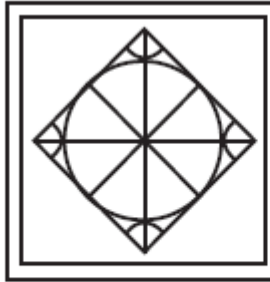
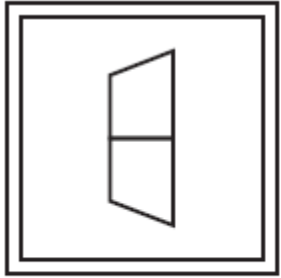

(a)

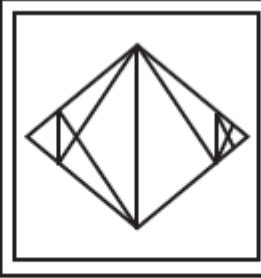

(b)

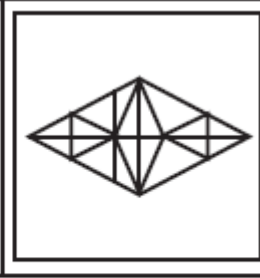

(c)

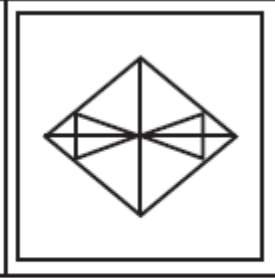

(d)

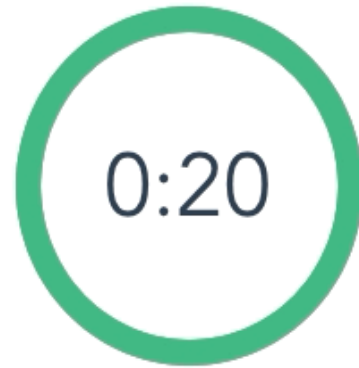

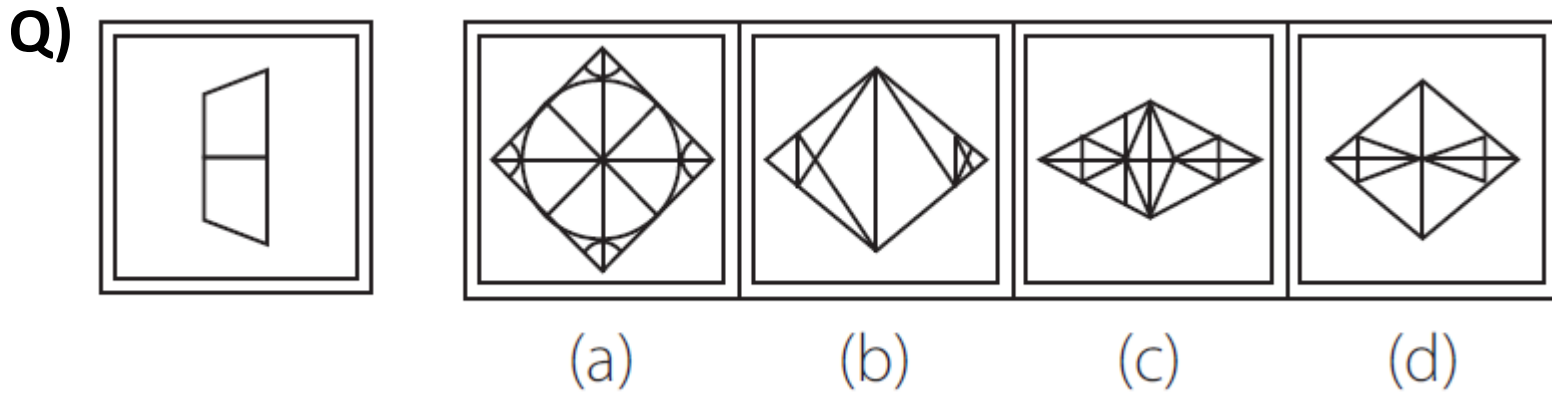

Ans: (c)

Q)

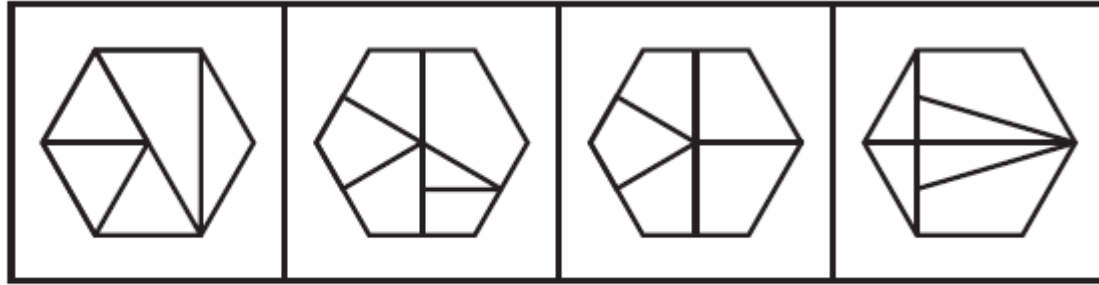



(a)

(b)

(c)

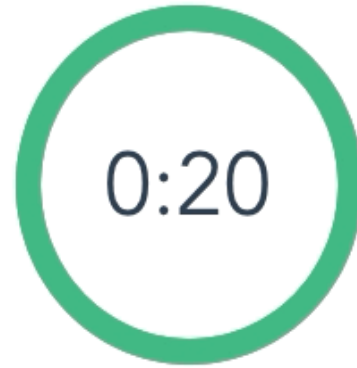
(d)



Q) 

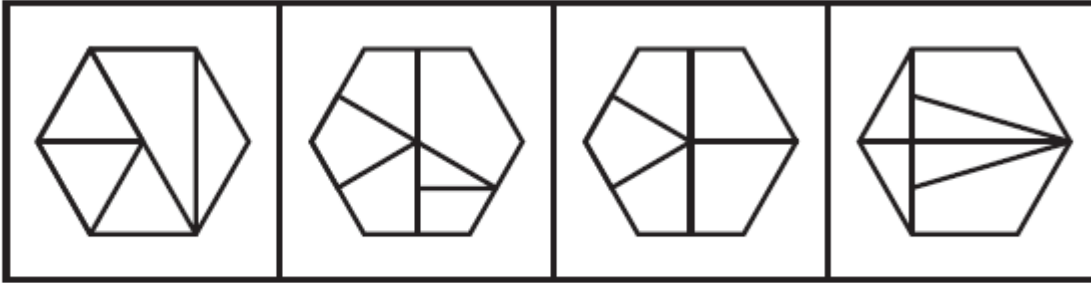

(a) (b) (c) (d)

Ans: (d)

Q)

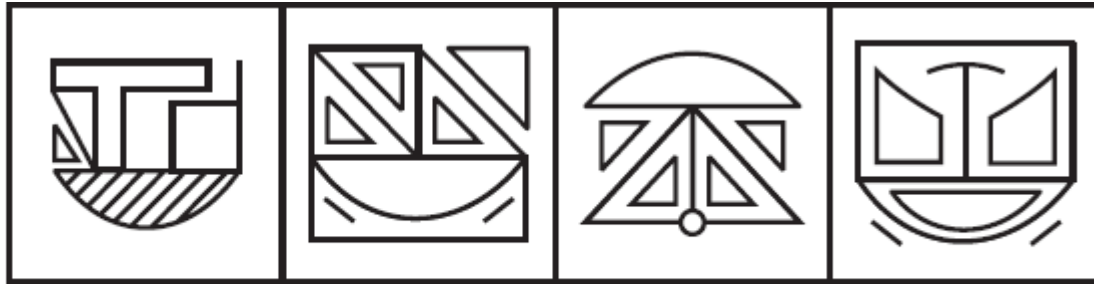

(a)

(b)

(c)

(d)

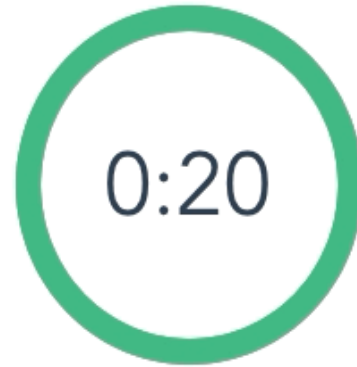

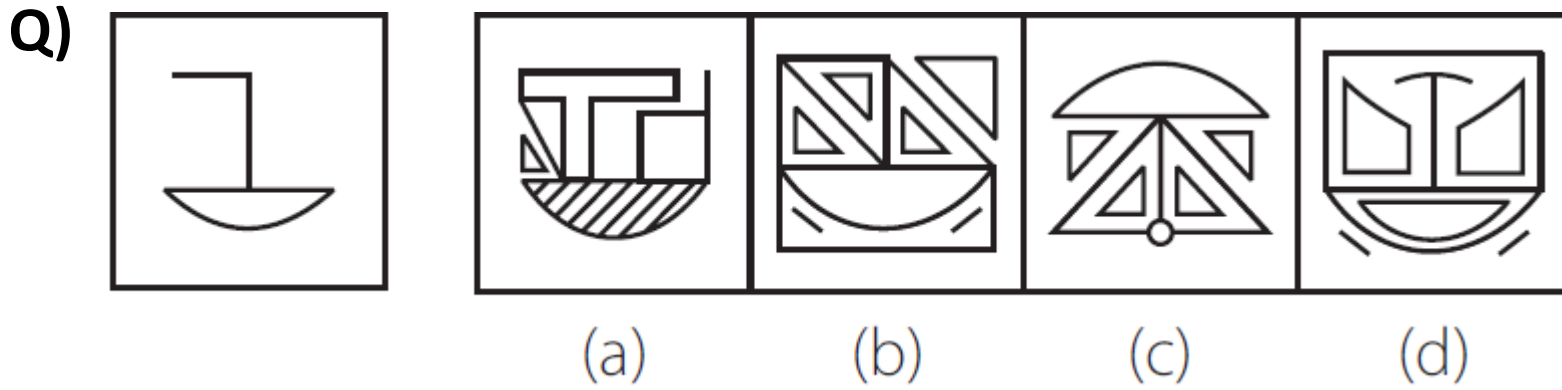

Ans: (b)

Q)

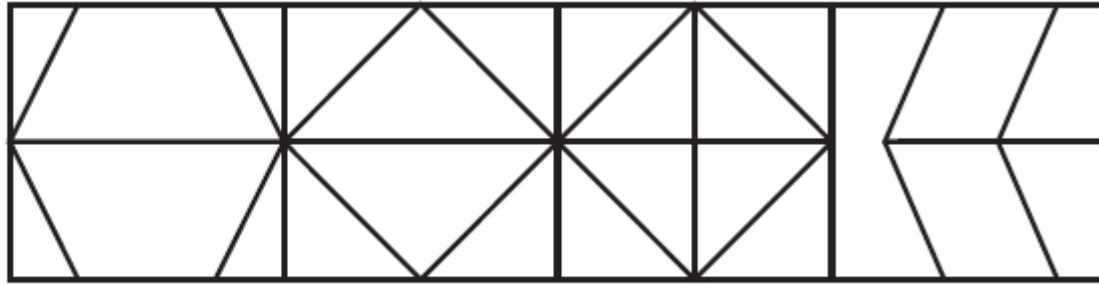
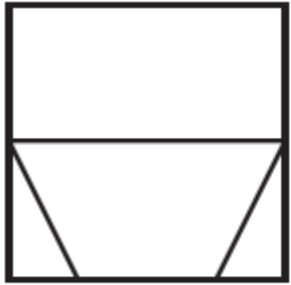

(a)

(b)

(c)

(d)

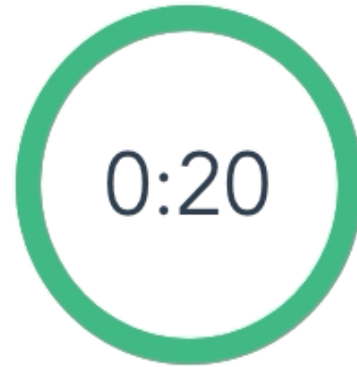

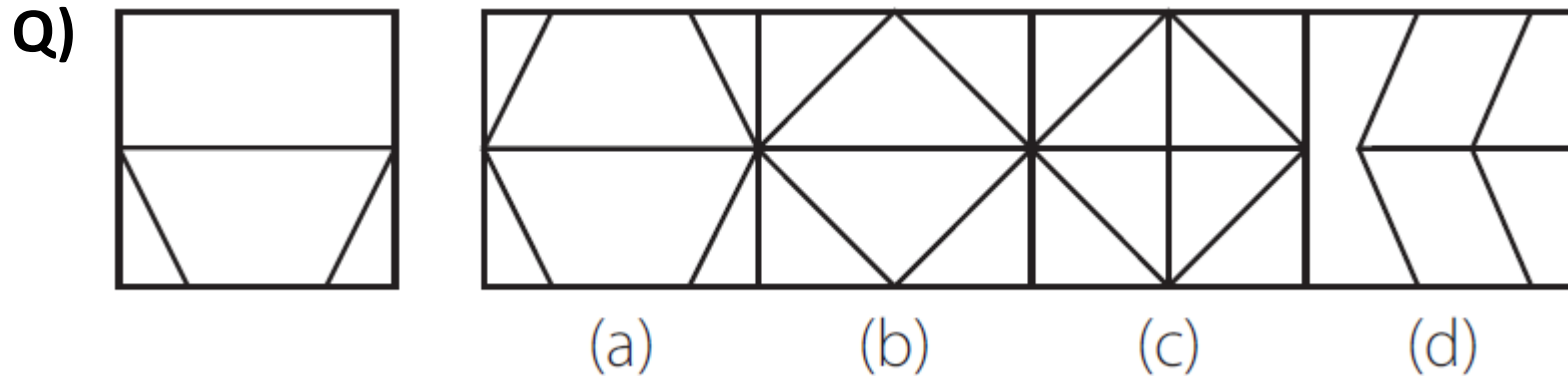

Ans: (a)

Q)

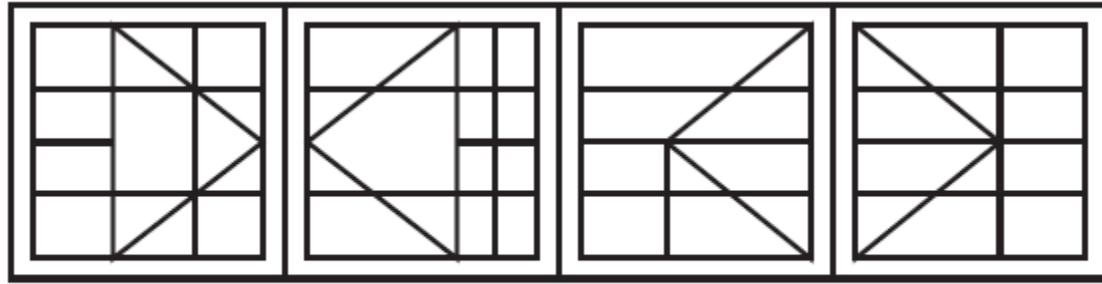
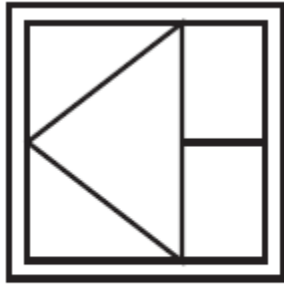

(a)

(b)

(c)

(d)

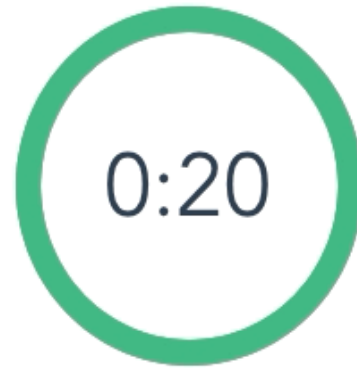

Q)

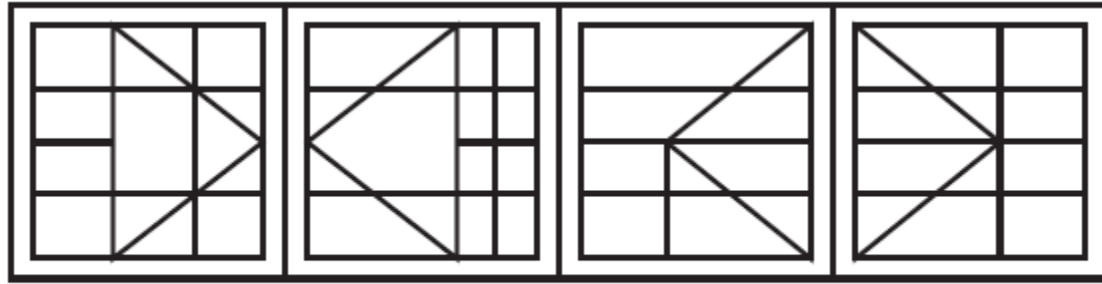
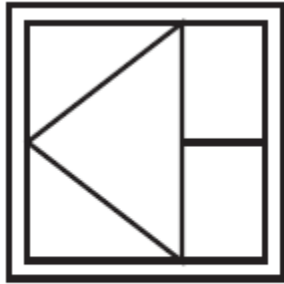

(a)

(b)

(c)

(d)

Ans: (b)

Q)

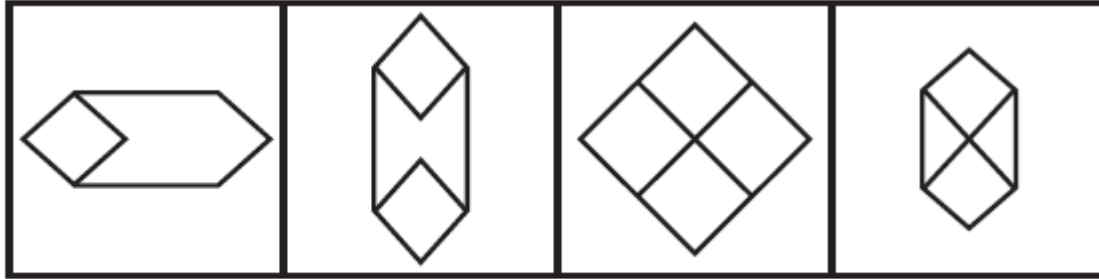

(a)

(b)

(c)

(d)

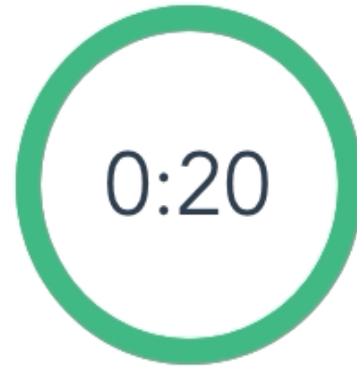

Q)

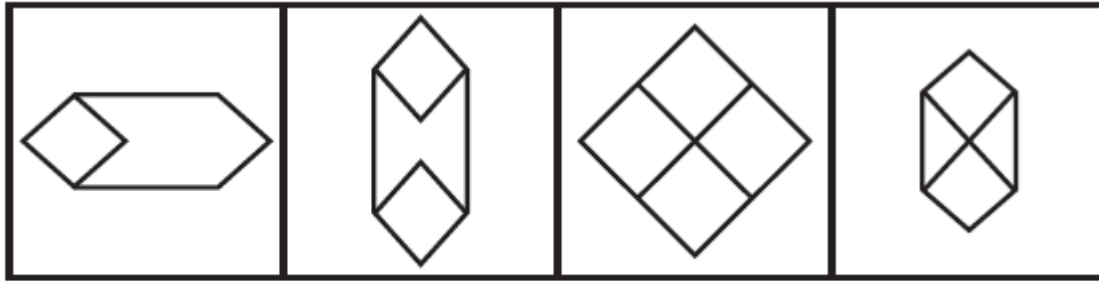

(a)

(b)

(c)

(d)

Ans: (b)

Q)

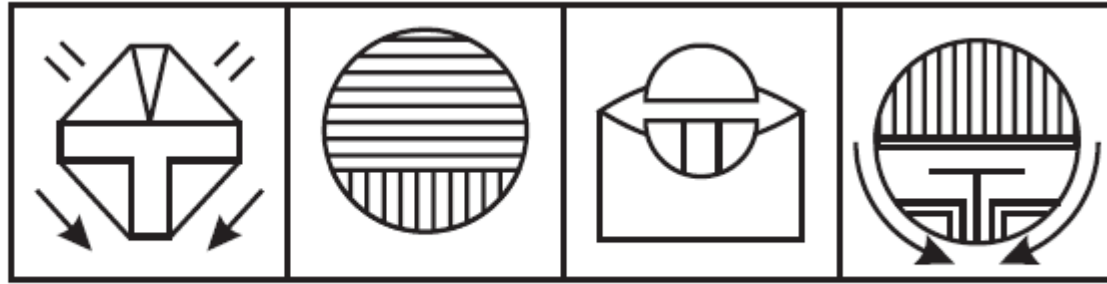
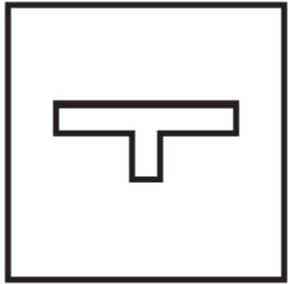

(a)

(b)

(c)

(d)

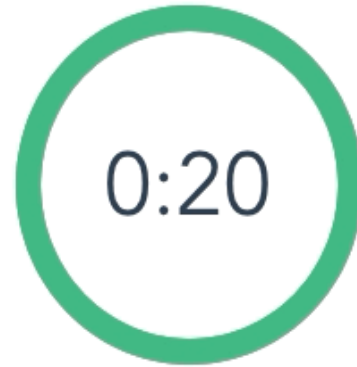

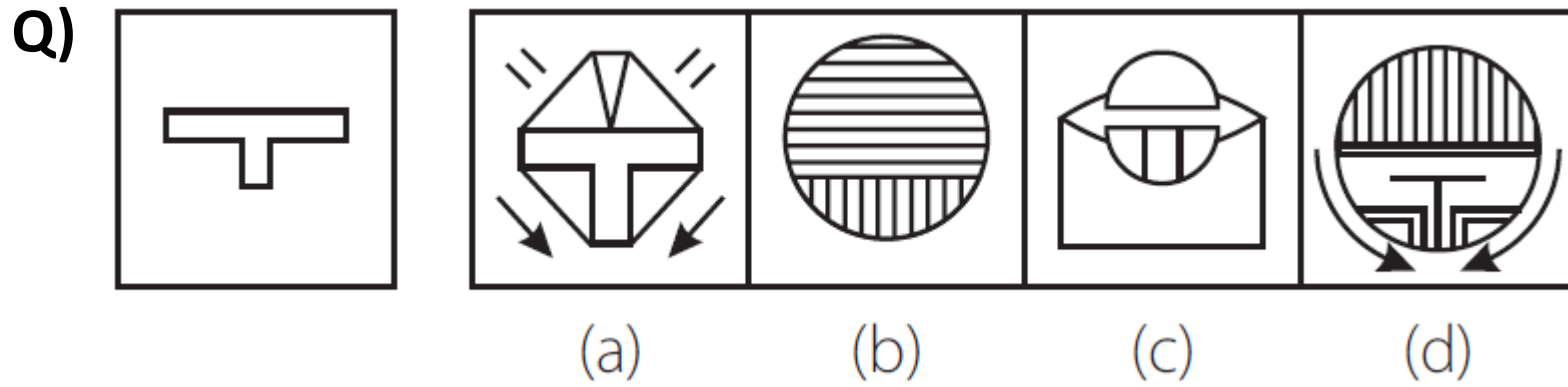

Ans: (a)

Q)

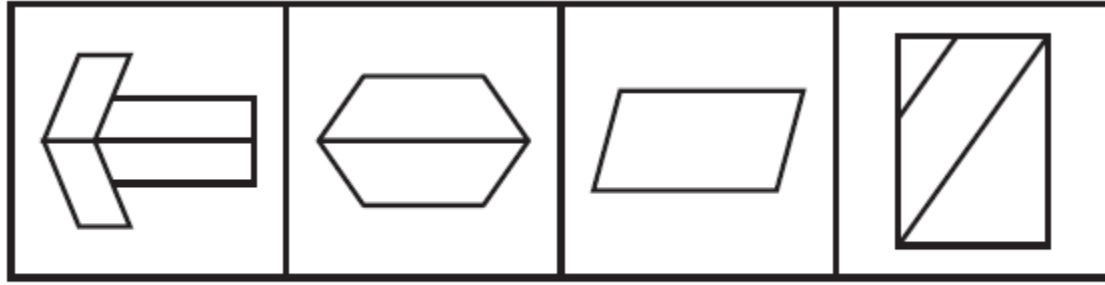
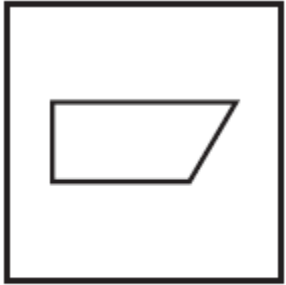

(a)

(b)

(c)

(d)

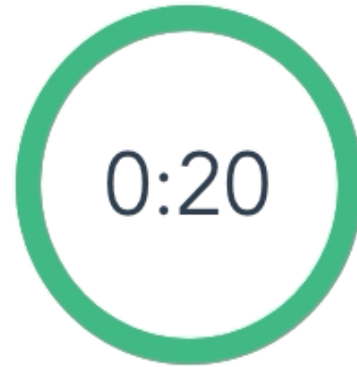

Q)

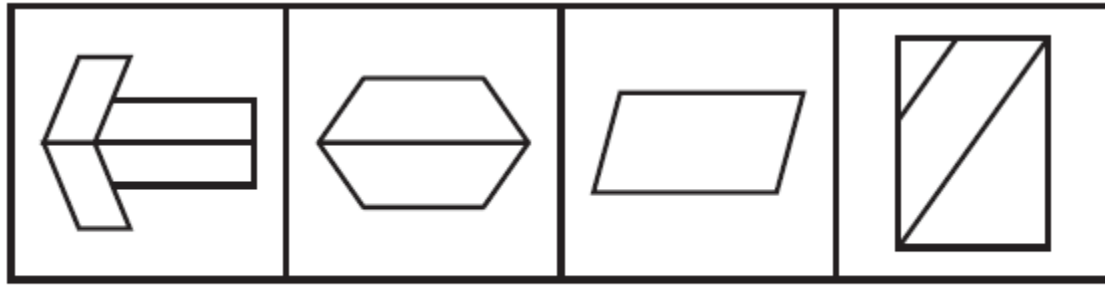
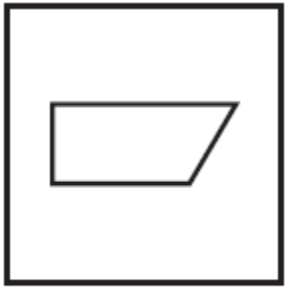

(a)

(b)

(c)

(d)

Ans: (a)

Q)

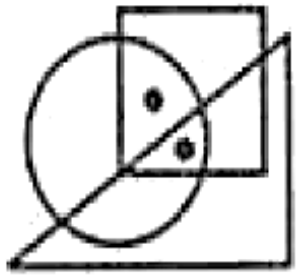

(X)

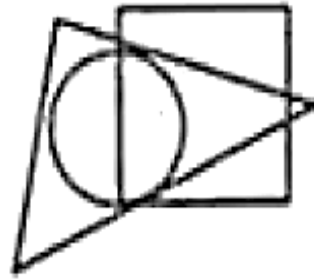

(a)



(b)

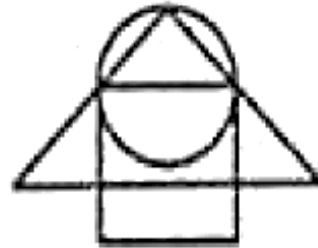

(c)

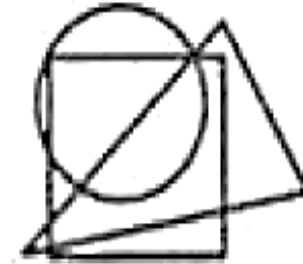

(d)

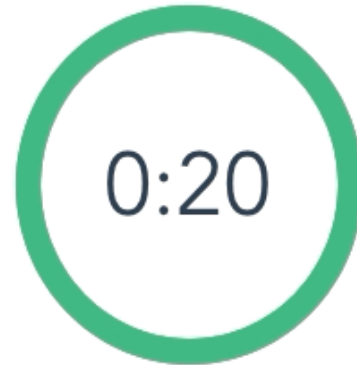

Q)

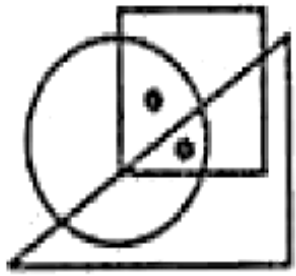

(X)

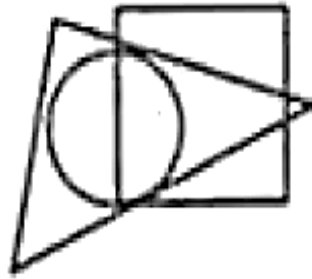

(a)

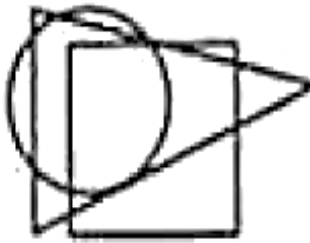

(b)

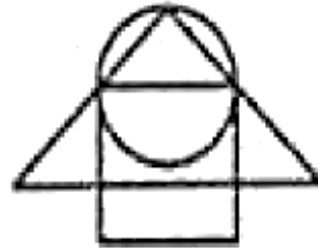

(c)

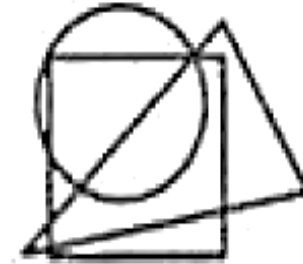

(d)

Ans: (d)

Q)

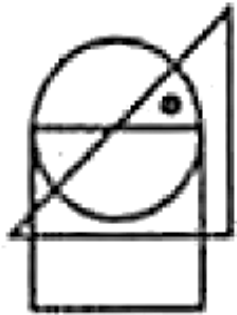

(X)



(a)



(b)



(c)

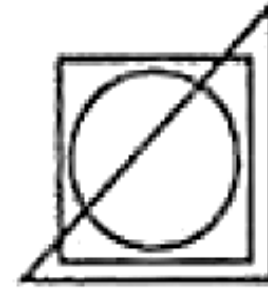

(d)

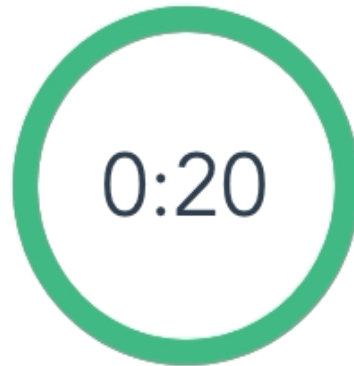

Q)

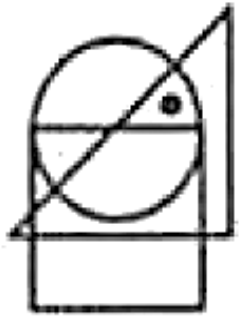

(X)



(a)



(b)



(c)

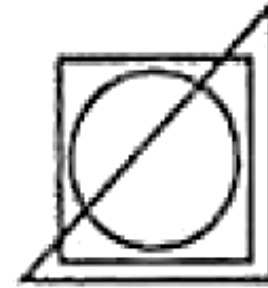

(d)

Ans: (c)

Q)



(X)



(a)



(b)

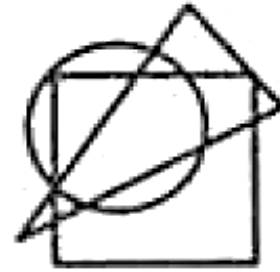

(c)



(d)

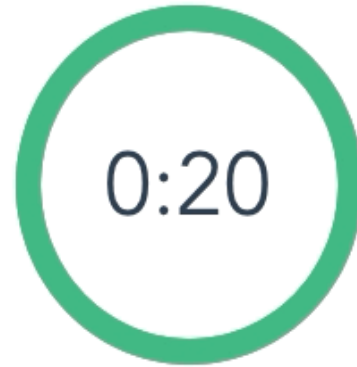

Q)



(X)



(a)



(b)

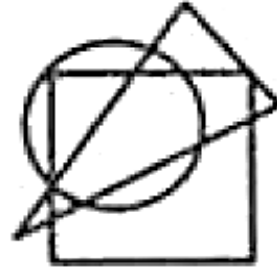

(c)



(d)

Ans: (c)

Q)



(X)

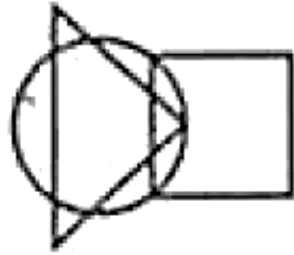

(a)



(b)



(c)

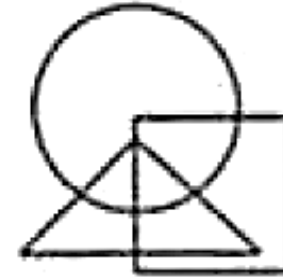

(d)

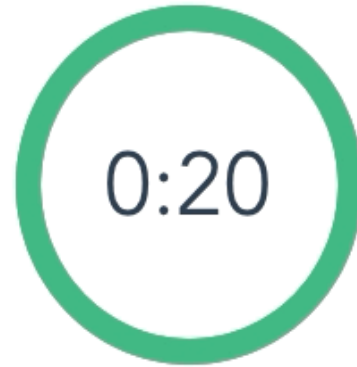

Q)

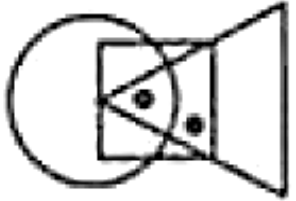

(X)

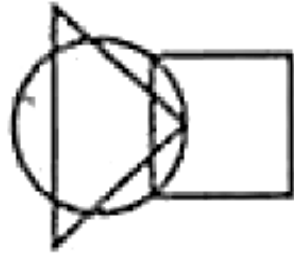

(a)



(b)



(c)

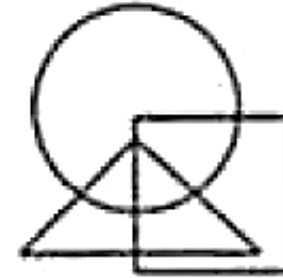

(d)

Ans: (d)

Q)

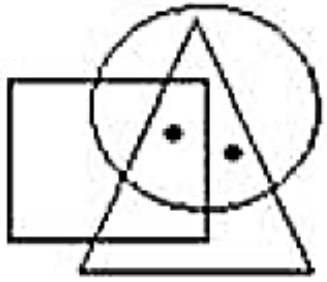

(X)

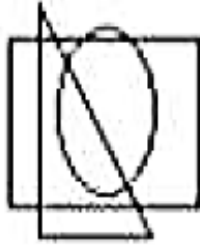

(a)

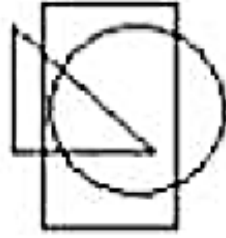

(b)

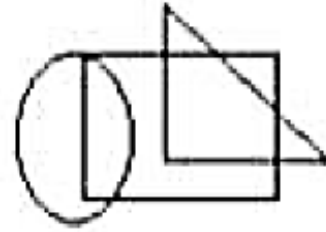

(c)



(d)

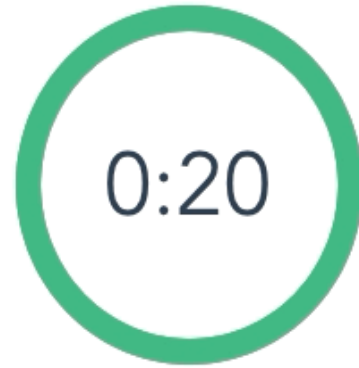

Q)

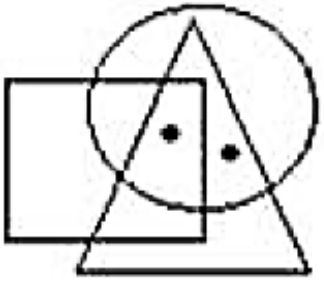

(X)

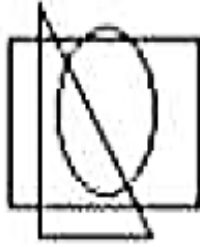

(a)

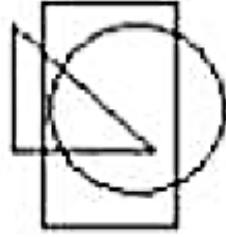

(b)

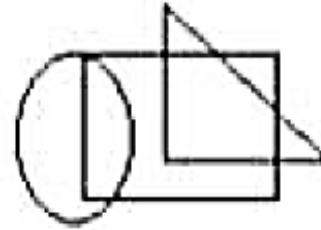

(c)



(d)

Ans: (d)

Q)

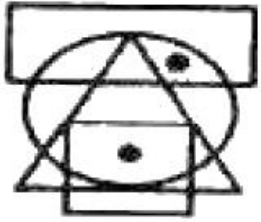

(X)

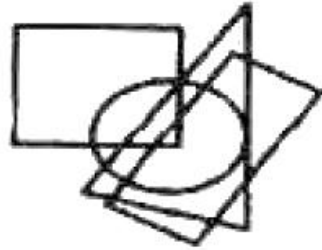

(a)

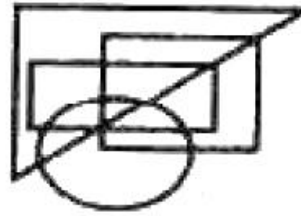

(b)

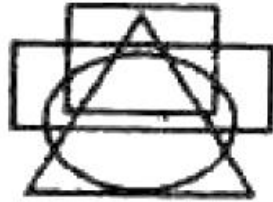

(c)

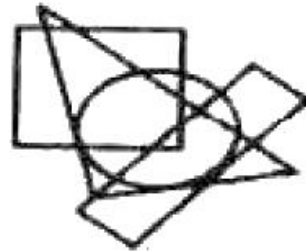

(d)

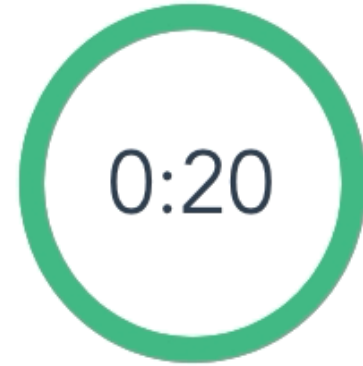

Q)

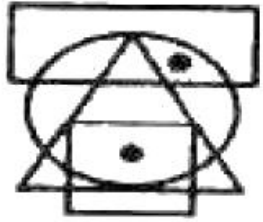

(X)

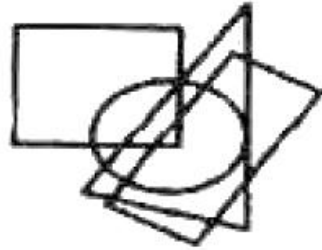

(a)

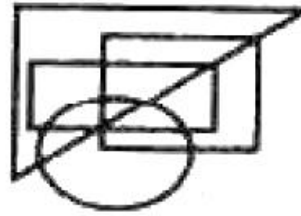

(b)

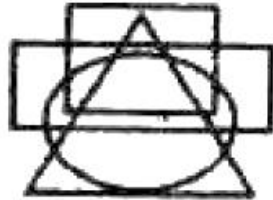

(c)

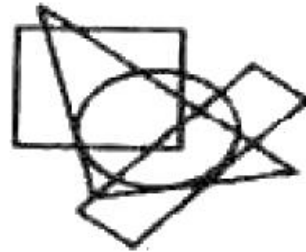

(d)

Ans: (d)

Q)

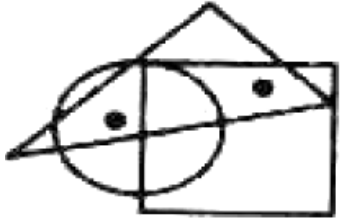

(X)

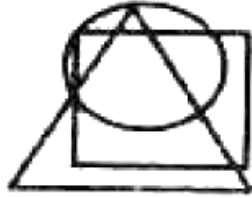

(a)



(b)

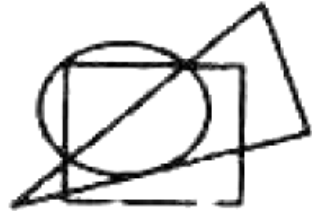

(c)

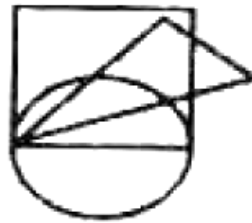

(d)

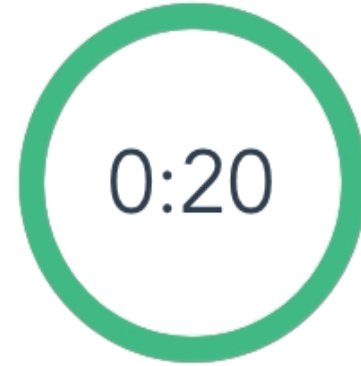

Q)

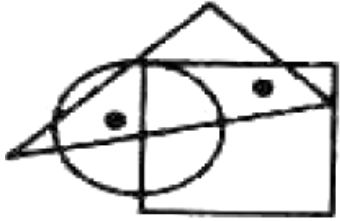

(X)

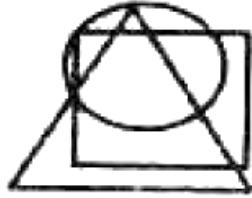

(a)



(b)

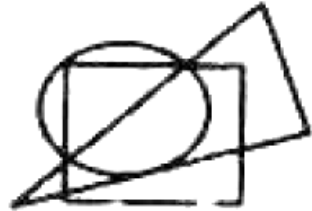

(c)

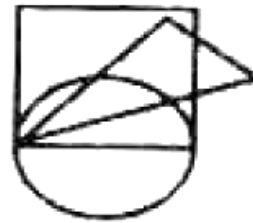

(d)

Ans: (a)

Q)



(X)



(a)

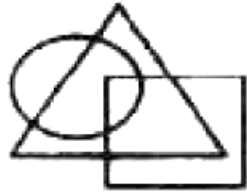

(b)

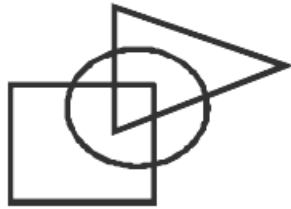

(c)



(d)

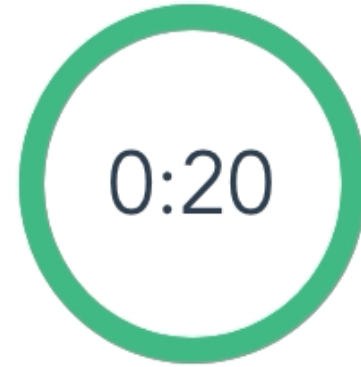

Q)



(X)



(a)

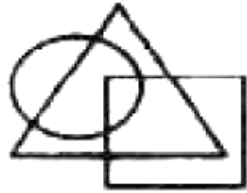

(b)

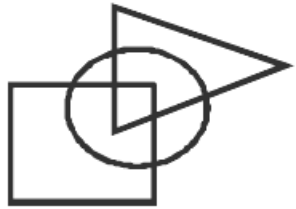

(c)



(d)

Ans: (c)

Q)

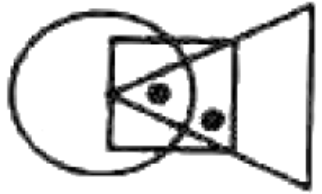

(X)

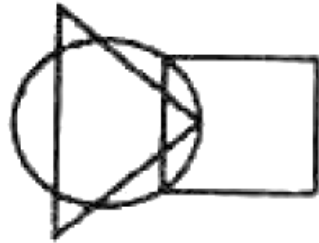

(a)



(b)



(c)

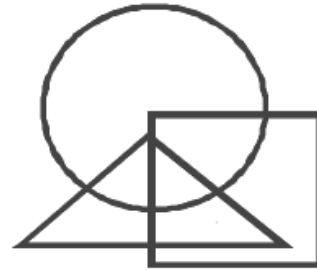

(d)

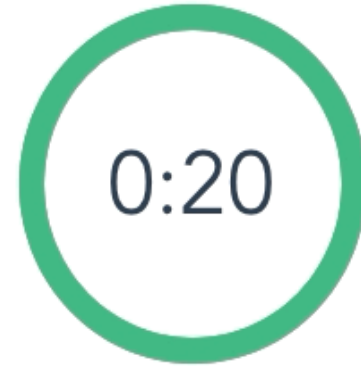

Q)

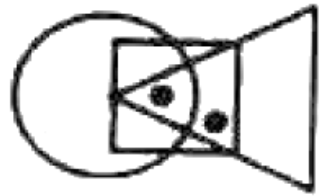

(X)

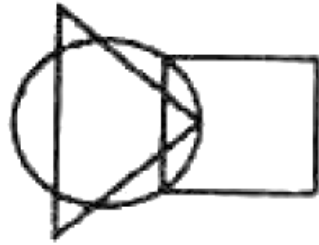

(a)

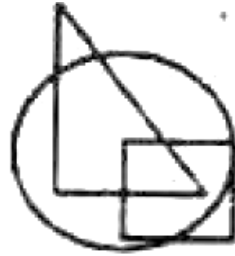

(b)



(c)

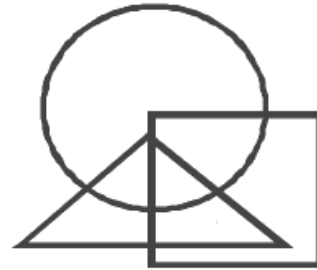

(d)

Ans: (d)

Q)



(X)



(a)

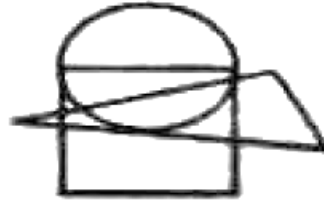

(b)

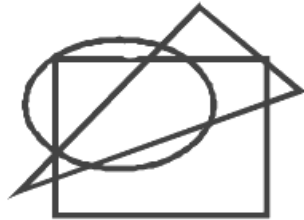

(c)

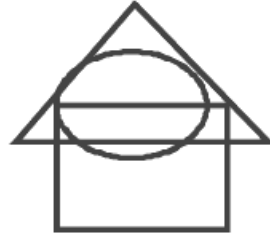

(d)

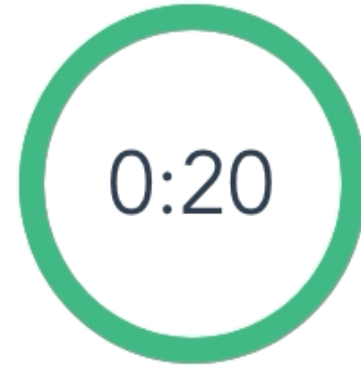

Q)



(X)



(a)

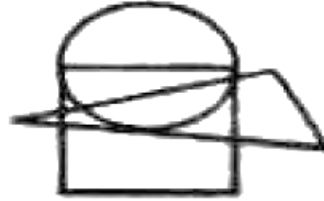

(b)

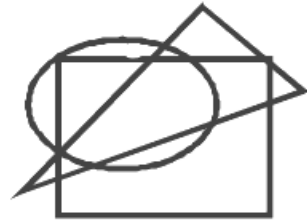

(c)

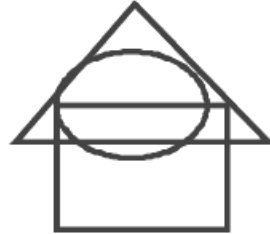

(d)

Ans: (c)

AFCAT 2 2022 – Reasoning Part 2

Q) Read all the conclusions and then decide which of the given conclusions logically follows from the given statements disregarding commonly known facts.

- (a) If only conclusion I follows.
- (b) If only conclusion II follows.
- (c) If either conclusion I or II follows.
- (d) If both conclusions I and II follow.

Statements:

Some Noise are steel

No steel is Blood

Some steel is Free

Conclusion:

I: Some noise are not Blood

II: All Blood is noise

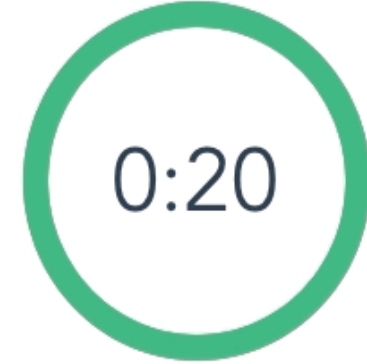

Q) Read all the conclusions and then decide which of the given conclusions logically follows from the given statements disregarding commonly known facts.

- (a) If only conclusion I follows.
- (b) If only conclusion II follows.
- (c) If either conclusion I or II follows.
- (d) If both conclusions I and II follow.

Statements:

Some Noise are steel

No steel is Blood

Some steel is Free

Conclusion:

I: Some noise are not Blood

II: All Blood is noise

Ans: (a)

Q) Statements:

All shirts are skirts.

No skirt is top.

All tops are kurta.

Conclusions:

I. All shirts are kurta

II. Some kurta are skirts.

Give answer

- (a) If only conclusion I follows.
- (b) If only conclusion II follows.
- (c) If either conclusion I or II follows.
- (d) If neither conclusion I nor II follows.



0:20

Q) Statements:

All shirts are skirts.

No skirt is top.

All tops are kurta.

Conclusions:

I. All shirts are kurta

II. Some kurta are skirts.

Give answer

- (a) If only conclusion I follows.
- (b) If only conclusion II follows.
- (c) If either conclusion I or II follows.
- (d) If neither conclusion I nor II follows.

Ans: (d)

Q) Statements:

All September are October.

No October is November.

No November is December.

Conclusions:

I Some September are not Novembers

II No October is December.

Give answer

- (a) If only conclusion I follows.
- (b) If only conclusion II follows.
- (c) If either conclusion I or II follows.
- (d) If neither conclusion I nor II follows.

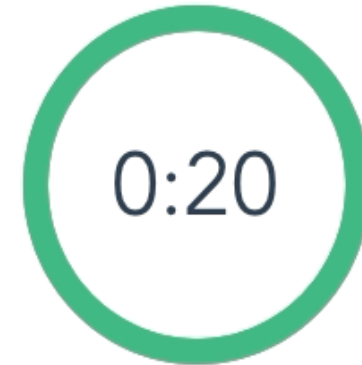

Q) Statements:

All September are October.

No October is November.

No November is December.

Conclusions:

I Some September are not Novembers

II No October is December.

Give answer

- (a) If only conclusion I follows.
- (b) If only conclusion II follows.
- (c) If either conclusion I or II follows.
- (d) If neither conclusion I nor II follows.

Ans: (a)

Q) Statement:

No right is a left.

All up are left.

Some down are up.

Conclusions:

I. No up is a right.

II. At least some down are left.

- (a) Only conclusion I is true
- (b) Neither conclusion I nor II is true
- (c) Only conclusion II is true
- (d) Both conclusions I and II are true

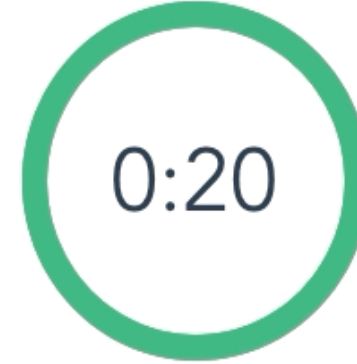

Q) Statement:

No right is a left.

All up are left.

Some down are up.

Conclusions:

I. No up is a right.

II. At least some down are left.

- (a) Only conclusion I is true
- (b) Neither conclusion I nor II is true
- (c) Only conclusion II is true
- (d) Both conclusions I and II are true

Ans: (d)

Q) Statements:

Some cricketers are footballers

All footballers are boxers.

Some boxers are players.

Conclusions:

I. At least some boxers are cricketers.

II. No player is a cricketer.

(a) Only conclusion I is true

(b) Neither conclusion I nor II is true

(c) Only conclusion II is true

(d) Both conclusions I and II are true

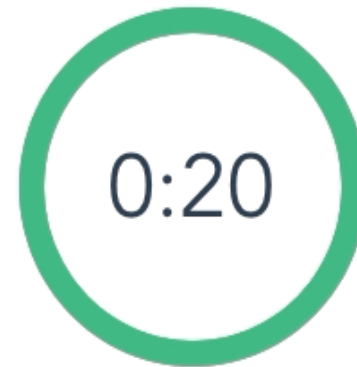

Q) Statements:

Some cricketers are footballers

All footballers are boxers.

Some boxers are players.

Conclusions:

I. At least some boxers are cricketers.

II. No player is a cricketer.

(a) Only conclusion I is true

(b) Neither conclusion I nor II is true

(c) Only conclusion II is true

(d) Both conclusions I and II are true

Ans: (a)

Q) Statements:

Some teachers are philosophers.

Some philosophers are writers.

Conclusions:

I. Some writers are teachers.

II. No writer is a teacher.

- (a) Only conclusion II follows
- (b) Either conclusion I or II follows
- (c) Neither conclusion I nor II follows
- (d) Only conclusion I follows

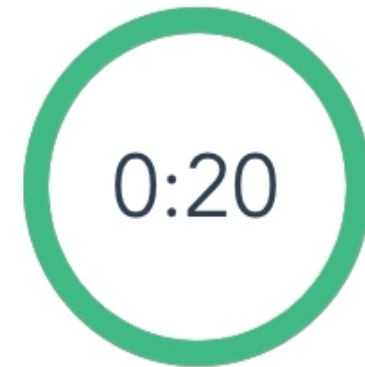

Q) Statements:

Some teachers are philosophers.

Some philosophers are writers.

Conclusions:

I. Some writers are teachers.

II. No writer is a teacher.

(a) Only conclusion II follows

(b) Either conclusion I or II follows

(c) Neither conclusion I nor II follows

(d) Only conclusion I follows

Ans: (b)

Q) Statements:

1. Some teachers are followers.
2. Some followers are famous.

Conclusions:

- I. Some teachers are famous.
 - II. Some followers are teachers.
- (a) Only conclusion I follows
 - (b) Only conclusion II follows
 - (c) Both conclusion I and II follows
 - (d) Neither conclusion I nor II follows

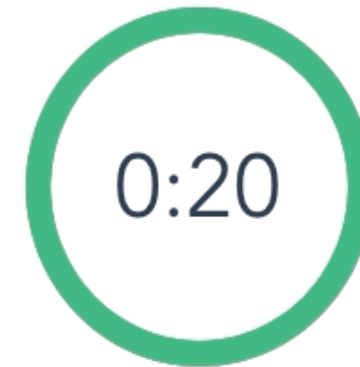

Q) Statements:

1. Some teachers are followers.
2. Some followers are famous.

Conclusions:

- I. Some teachers are famous.
 - II. Some followers are teachers.
- (a) Only conclusion I follows
 - (b) Only conclusion II follows
 - (c) Both conclusion I and II follows
 - (d) Neither conclusion I nor II follows

Ans: (b)

Statements:

Q)

I. Some towers are windows.

II. All windows are houses.

III. Some houses are temples.

Conclusions:

I. Some towers are temples.

II. Some houses are towers.

(a) Only conclusion I follows.

(b) Only conclusion II follows.

(c) Both conclusions I & II follow.

(d) Neither conclusion I nor II follows.

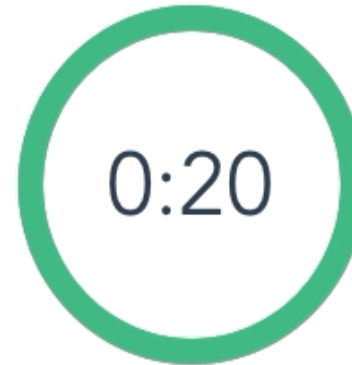

Statements:

Q)

I. Some towers are windows.

II. All windows are houses.

III. Some houses are temples.

Conclusions:

I. Some towers are temples.

II. Some houses are towers.

(a) Only conclusion I follows.

(b) Only conclusion II follows.

(c) Both conclusions I & II follow.

(d) Neither conclusion I nor II follows.

Ans: (b)

Q) Statements:

I. Some balls are points.

II. All points are pens.

III. All pens are gels.

Conclusions:

I. All balls are pens.

II. All pens are balls.

(a) if only Conclusion I follows

(b) if only Conclusion II follows

(c) if either Conclusion I or II follows

(d) if neither Conclusion I nor II follows

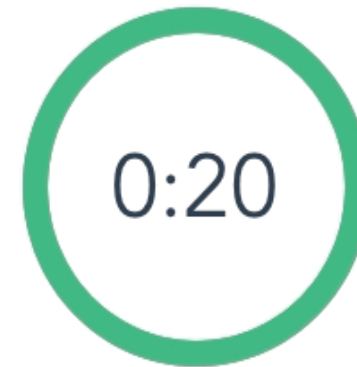

Q) Statements:

I. Some balls are points.

II. All points are pens.

III. All pens are gels.

Conclusions:

I. All balls are pens.

II. All pens are balls.

(a) if only Conclusion I follows

(b) if only Conclusion II follows

(c) if either Conclusion I or II follows

(d) if neither Conclusion I nor II follows

Ans: (d)

Q) Statements:

- I. All pens are papers.
- II. Some papers are blades.
- III. All blades are knives.

Conclusions:

- I. Some knives are papers.
- II. Some blades are pens.
- (a) if only Conclusion I follows
- (b) if only Conclusion II follows
- (c) if either Conclusion I or II follows
- (d) if neither Conclusion I nor II follows

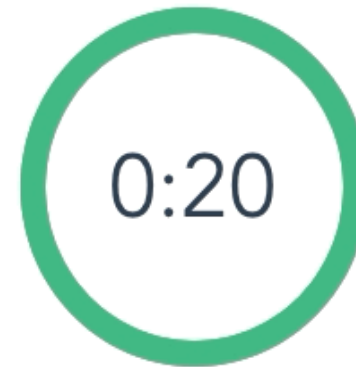

Q) Statements:

- I. All pens are papers.
- II. Some papers are blades.
- III. All blades are knives.

Conclusions:

- I. Some knives are papers.
 - II. Some blades are pens.
- (a) if only Conclusion I follows
 - (b) if only Conclusion II follows
 - (c) if either Conclusion I or II follows
 - (d) if neither Conclusion I nor II follows

Ans: (a)

Statements:

Q)

I. All fans are televisions.

II. Some televisions are channels.

III. Some channels are radios.

Conclusions:

I. Some fans are channels.

II. Some radios are televisions.

(a) if only Conclusion I follows

(b) if only Conclusion II follows

(c) if either Conclusion I or II follows

(d) if neither Conclusion I nor II follows

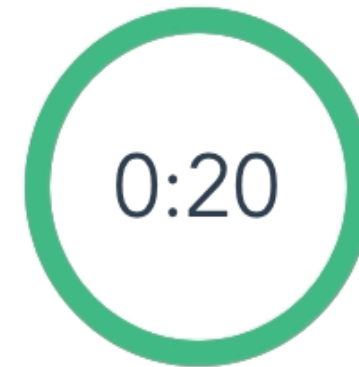

Statements:

Q)

I. All fans are televisions.

II. Some televisions are channels.

III. Some channels are radios.

Conclusions:

I. Some fans are channels.

II. Some radios are televisions.

(a) if only Conclusion I follows

(b) if only Conclusion II follows

(c) if either Conclusion I or II follows

(d) if neither Conclusion I nor II follows

Ans: (d)

Q) Statements:

- I. Some roots are stems.
- II. All stems are branches.
- III. All branches are leaves.

Conclusions:

- I. Some leaves are roots.
- II. Some branches are stems.
- (a) Only conclusion I follows.
- (b) Only conclusion II follows.
- (c) Both conclusions I & II follow.
- (d) Neither conclusion I nor II follows.

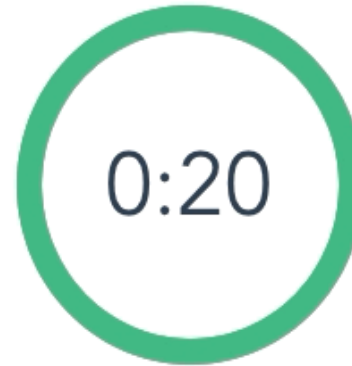

Q) Statements:

- I. Some roots are stems.
- II. All stems are branches.
- III. All branches are leaves.

Conclusions:

- I. Some leaves are roots.
 - II. Some branches are stems.
- (a) Only conclusion I follows.
 - (b) Only conclusion II follows.
 - (c) Both conclusions I & II follow.
 - (d) Neither conclusion I nor II follows.

Ans: (c)

Q) Statements:

- I. All windows are doors.
- II. All entrances are windows.
- III. No gate is a door.

Conclusions:

- I. Atleast some windows are gates.
 - II. No gate is an entrance.
- (a) if only Conclusion I follows
 - (b) if only Conclusion II follows
 - (c) if either Conclusion I or II follows
 - (d) if neither Conclusion I nor II follows

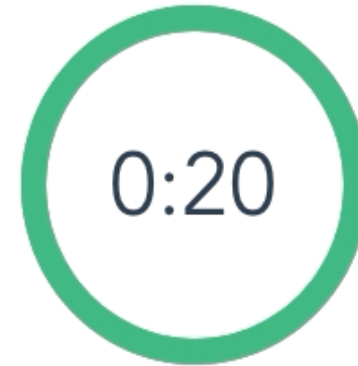

Q) Statements:

- I. All windows are doors.
- II. All entrances are windows.
- III. No gate is a door.

Conclusions:

- I. Atleast some windows are gates.
 - II. No gate is an entrance.
- (a) if only Conclusion I follows
 - (b) if only Conclusion II follows
 - (c) if either Conclusion I or II follows
 - (d) if neither Conclusion I nor II follows

Ans: (b)

Q) Statements:

- I. All letters are black.
- II. All blacks are blue.
- III. All blues are green.

Conclusions:

- I. No letter is green.
- II. Most blue are blacks.
- (a) if only Conclusion I follows
- (b) if only Conclusion II follows
- (c) if either Conclusion I or II follows
- (d) if neither Conclusion I nor II follows

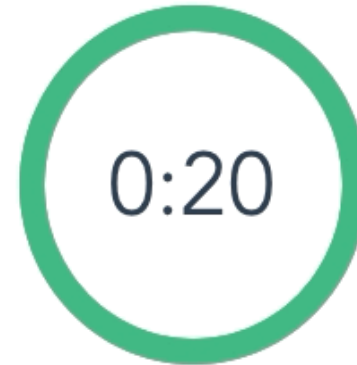

Q) Statements:

- I. All letters are black.
- II. All blacks are blue.
- III. All blues are green.

Conclusions:

- I. No letter is green.
 - II. Most blue are blacks.
- (a) if only Conclusion I follows
 - (b) if only Conclusion II follows
 - (c) if either Conclusion I or II follows
 - (d) if neither Conclusion I nor II follows

Ans: (b)

Q) Statements:

- I. Some books are pens.
- II. Some pens are pencils.
- III. Some pencils are buttons.

Conclusions:

- I. Some buttons are pens.
- II. Some pencils are books.
- (a) if only Conclusion I follows
- (b) if only Conclusion II follows
- (c) if either Conclusion I or II follows
- (d) if neither Conclusion I nor II follows

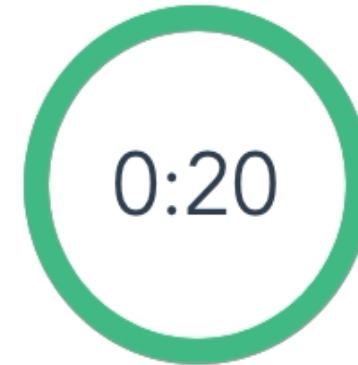

Q) Statements:

- I. Some books are pens.
- II. Some pens are pencils.
- III. Some pencils are buttons.

Conclusions:

- I. Some buttons are pens.
 - II. Some pencils are books.
- (a) if only Conclusion I follows
 - (b) if only Conclusion II follows
 - (c) if either Conclusion I or II follows
 - (d) if neither Conclusion I nor II follows

Ans: (d)

Q) Statements

- (a) All goats are cows.
- (b) All cows are animals.

Conclusion

- (I) All goats are animals.
- (II) All animals are goats.
- (a) Only conclusion I follows.
- (b) Only conclusion II follows.
- (c) Both conclusion I and II follows.
- (d) Neither conclusion I nor II follows.

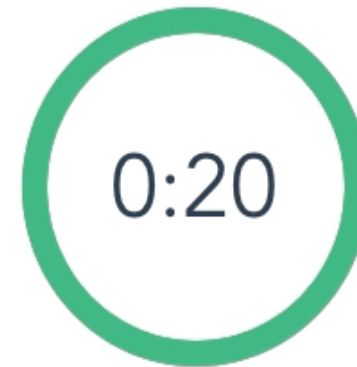

Q) Statements

- (a) All goats are cows.
- (b) All cows are animals.

Conclusion

- (I) All goats are animals.
 - (II) All animals are goats.
- (a) Only conclusion I follows.
 - (b) Only conclusion II follows.
 - (c) Both conclusion I and II follows.
 - (d) Neither conclusion I nor II follows.

Ans: (a)

Q) Statements

- (a) Some cats are dogs.
- (b) No dog is a toy.

Conclusion

- (I) Some dogs are cats.
 - (II) Some cats are not toys.
- (a) Only conclusion I follows.
 - (b) Only conclusion II follows.
 - (c) Both conclusion I and II follows.
 - (d) Neither conclusion I nor II follows.

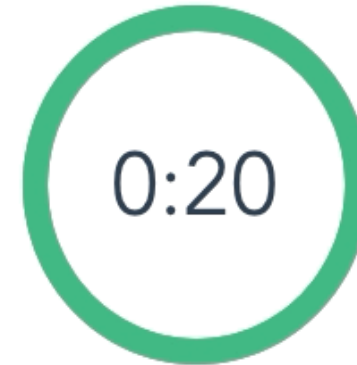

Q) Statements

- (a) Some cats are dogs.
- (b) No dog is a toy.

Conclusion

- (I) Some dogs are cats.
 - (II) Some cats are not toys.
- (a) Only conclusion I follows.
 - (b) Only conclusion II follows.
 - (c) Both conclusion I and II follows.
 - (d) Neither conclusion I nor II follows.

Ans: (c)

Q) Statements

- (a) All teachers are experienced.
- (b) Some teachers are spinsters.

Conclusions

- (I) Some experienced are spinsters
 - (II) Some spinsters are experienced.
- (a) Only conclusion I or II follow
 - (b) Either conclusion I or II follow
 - (c) Both conclusion I and II follow
 - (d) Only conclusion I follows

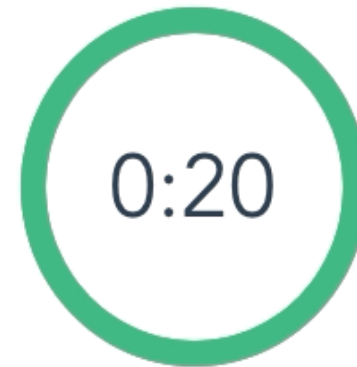

Q) Statements

- (a) All teachers are experienced.
- (b) Some teachers are spinsters.

Conclusions

- (I) Some experienced are spinsters
 - (II) Some spinsters are experienced.
- (a) Only conclusion I or II follow
 - (b) Either conclusion I or II follow
 - (c) Both conclusion I and II follow
 - (d) Only conclusion I follows

Ans: (c)

1-YEAR FULL ACCESS SSB ONLINE COURSE 2022

START YOUR SSB INTERVIEW PREPARATION TODAY WITH SSBCRACKEXAMS

HOT & NEW



5 (132 ratings) 17,552 students enrolled

Includes:

 OIR Test

 PPDT

 Psychological Tests

 Personal Interview

 Group Tasks

 Conference

 Medical

 Live Class

 Success Stories

 Personal Guidance

 SSB Trends



Bundles 16[View All](#)

SSB Interview Online Course

17 Courses

₹3,999 ₹4,999 20% OFF

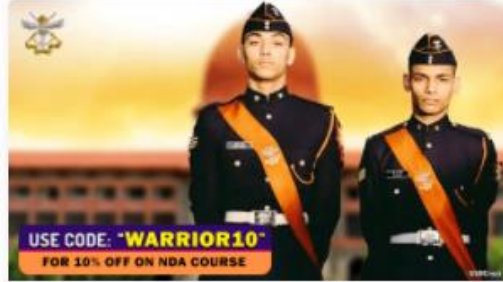

NDA Exam Online Course 2022

23 Courses

₹3,999 ₹4,999 20% OFF



CDS Exam Online Course 2022

39 Courses

₹3,999 ₹4,999 20% OFF



AFCAT Exam Online Course 2022

23 Courses

₹3,999 ₹4,999 20% OFF

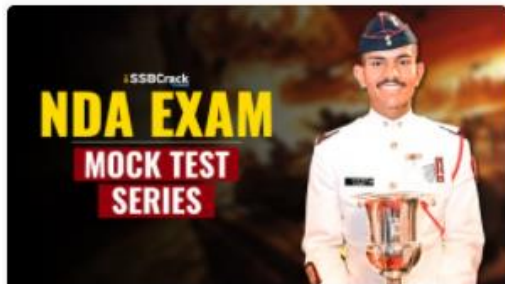
Test Series 07[View All](#)

NDA 2022 Mock Test Series

40 Tests

₹499 ₹999 50% OFF



CDS Exam 2022 Mock Test Series

30 Tests

₹499 ₹999 50% OFF



AFCAT 2022 Mock Test Series

20 Tests

₹499 ₹999 50% OFF

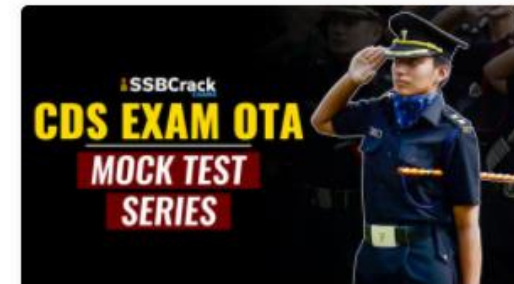

CDS Exam OTA 2022 Mock Test Series

20 Tests

₹499 ₹999 50% OFF

AFCAT 2 2022

LIVE CLASS

TIME TABLE

DATE	TIME	SUBJECT
17 AUG 2022	10 AM TO 1 PM	General Awareness Part 1
17 AUG 2022	2 PM TO 5 PM	English Part 1
17 AUG 2022	6 PM TO 9 PM	Static GK Part 1
18 AUG 2022	10 AM TO 1 PM	General Awareness Part 2
18 AUG 2022	2 PM TO 5 PM	English Part 2
18 AUG 2022	6 PM TO 9 PM	Static GK Part 2
19 AUG 2022	10 AM TO 1 PM	Current Affairs
19 AUG 2022	2 PM TO 5 PM	English Part 3
19 AUG 2022	6 PM TO 9 PM	Defence Current Affairs
20 AUG 2022	10 AM TO 1 PM	Numerical Ability Part 1
20 AUG 2022	2 PM TO 5 PM	Reasoning Part 1
20 AUG 2022	6 PM TO 9 PM	General Sciences
22 AUG 2022	10 AM TO 1 PM	Numerical Ability Part 2
22 AUG 2022	2 PM TO 5 PM	Reasoning Part 2
23 AUG 2022	10 AM TO 1 PM	Numerical Ability Part 3
23 AUG 2022	2 PM TO 5 PM	Reasoning Part 3



India's Most Popular Portal for Defence Exam Preparation

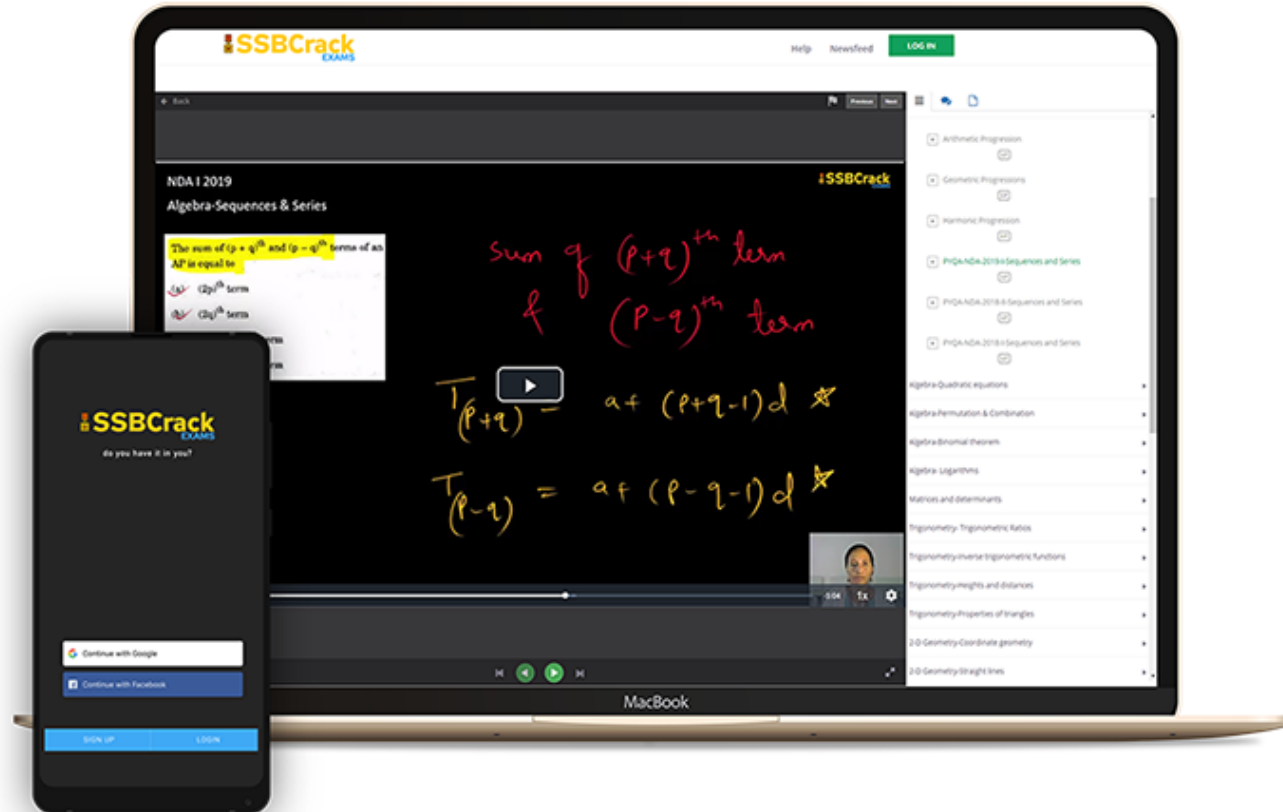

www.ssbcrackexams.com

CODE: WARRIOR10

get an extra **10%** off on all courses



Courses

ACC (1) AFCAT (1) AIRMEN (2) CAPF (1) CDS EXAM (2) INET OFFICER (1) MNS (1) MOCK TEST (3) NDA EXAM (1) PC(SL) (1) SCO (1) SSB INTERVIEW (1) TERRITORIAL ARMY (1)



HIGHEST RATED

517 PEOPLE ONLINE NOW

CDS Exam Online Course 2021 – 2022

★★★★★ 5 (80)

₹ 4,999.00



BEST SELLER

997 PEOPLE ONLINE NOW

CDS OTA Exam Online Course 2021 – 2022

★★★★★ 5 (77)

₹ 4,499.00



BEST SELLER

206 PEOPLE ONLINE NOW

AFCAT Exam Online Course 2022

★★★★★ 5 (64)

₹ 4,999.00



HIGHEST RATED

561 PEOPLE ONLINE NOW

NDA Exam Online Course 2021 – 2022

★★★★★ 5 (72)

₹ 4,999.00



HOT & NEW

740 PEOPLE ONLINE NOW

Territorial Army Exam Online Course 2021 – 2022

★★★★★ 5 (53)

₹ 4,999.00



HOT & NEW

995 PEOPLE ONLINE NOW

ACC Exam Online Course Army Cadet College 2021 – 2022

★★★★★ 5 (53)

₹ 6,999.00



HOT & NEW

OIR TEST & PPDT

90 PEOPLE ONLINE NOW

OIR Test and PPDT Online Course – Officers Intelligence Rating Test

★★★★★ 5 (50)

₹ 2,999.00



BEST SELLER

98 PEOPLE ONLINE NOW

MNS Military Nursing Service Exam Online Course 2022

★★★★★ 5 (44)

₹ 4,999.00



HOT & NEW

AFCAT EXAM MOCK TEST SERIES

37 PEOPLE ONLINE NOW

AFCAT Exam Online Mock Test Series

★★★★★ 5 (65)

₹ 299.00



BEST SELLER

CDS EXAM MOCK TEST SERIES

36 PEOPLE ONLINE NOW

CDS Exam Online Mock Test Series

★★★★★ 5 (79)

₹ 299.00

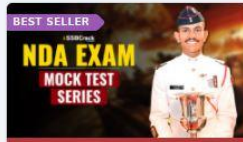

BEST SELLER

NDA EXAM MOCK TEST SERIES

18 PEOPLE ONLINE NOW

NDA Exam Online Mock Test Series

★★★★★ 5 (72)

₹ 299.00



HOT & NEW

37 PEOPLE ONLINE NOW

UPSC CAPF Assistant Commandant Online Course 2022

★★★★★ 5 (46)

₹ 4,999.00

