



AFCAT 2 2024

MAHA MARATHON #1



COMPLETE REVISION

5TH AUG 2024
1 PM TO 5 PM



LIVE CLASS



AFCAT 2 2024

MAHA MARATHON

05 TO 08 AUG 2024

01 PM TO 02 PM

REASONING - RUBY MA'AM

02 PM TO 03 PM

ENGLISH - ANURADHA MA'AM

03 PM TO 04 PM

STATIC GK - DIVYANSHU SIR

04 PM TO 05 PM

MATHS - NAVJYOTI SIR

 CALL US: 080-69185400

 GET IT ON
Google Play

DOWNLOAD
THE APP NOW



Clock : Time :: Thermometer

- A. Heat
- B. Radiation
- C. Energy
- D. Temperature

Clock : Time :: Thermometer

- A. Heat
- B. Radiation
- C. Energy
- D. Temperature**

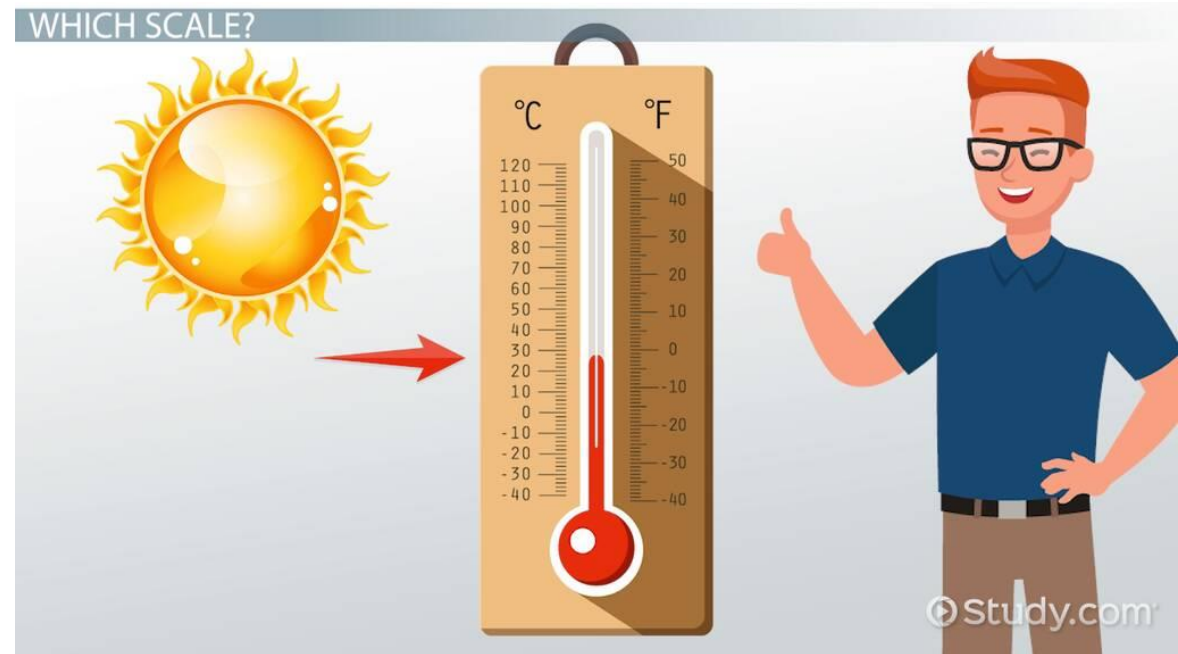

ACTION : REACTION

A. Introvert : Extrovert

B. Assail : Defend

C. Diseased : Treatment

D. Death : Rebirth

ACTION : REACTION

A. Introvert : Extrovert

B. Assail : Defend

C. Diseased : Treatment

D. Death : Rebirth

Reaction Is In Response To An Action Just As A Defence Is In Response To An Assail. All Other Pairs Have A Different Relationship.

what's the
opposite of
assail?



defend, protect, praise,
compliment, uphold, exonerate,
retreat, surrender, help,
let go



EDITOR : NEWSPAPER

- A. Lecturer : University
- B. Teacher : School
- C. Nurse : Hospital
- D. Architect : Design

EDITOR : NEWSPAPER

A. Lecturer : University

B. Teacher : School

C. Nurse : Hospital

D. Architect : Design

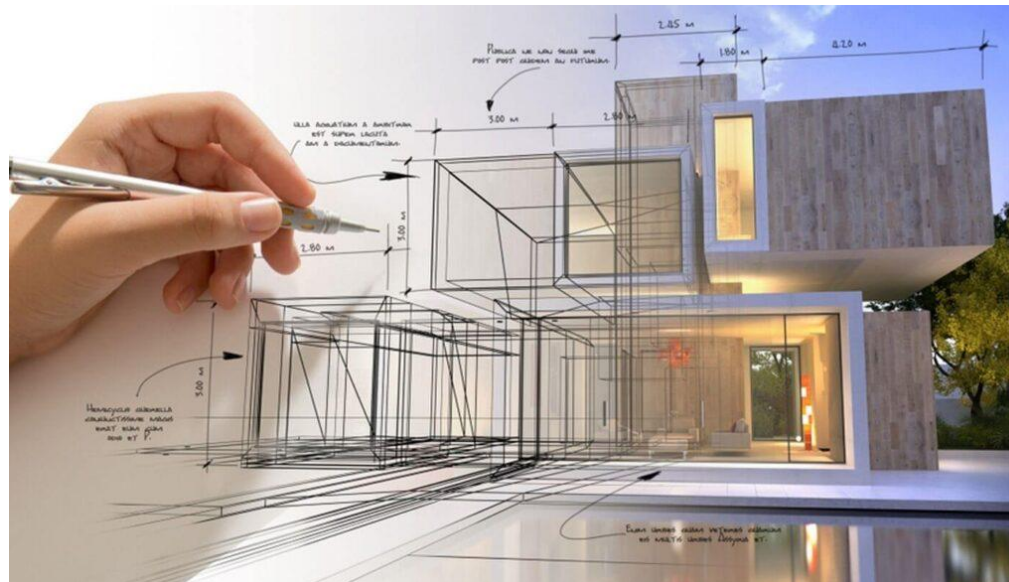

MANAGER : OFFICE

- A. Doctor : Patient
- B. Curator : Museum
- C. Bank : Account
- D. Fruit : Seed

MANAGER : OFFICE

A. Doctor : Patient

B. Curator : Museum

C. Bank : Account

D. Fruit : Seed



Morning : Evening : Dusk

- A. Triangle : Quadrilateral : Pentagon
- B. Happy : Gay : Excited
- C. Summer : Winter : Autumn
- D. Botany : Zoology : Physiology

Morning : Evening : Dusk

- A. Triangle : Quadrilateral : Pentagon
- B. Happy : Gay : Excited
- C. Summer : Winter : Autumn**
- D. Botany : Zoology : Physiology



In A Certain Way 'Diploma' Is Related To 'Education'. Which Of The Following Is Related To 'Trophy' In A Similar Way

- A. Sports
- B. Athlete
- C. Winning
- D. Prize

In A Certain Way 'Diploma' Is Related To 'Education'. Which Of The Following Is Related To 'Trophy' In A Similar Way

A. Sports

A Diploma Is Awarded To A Student After They Successfully Complete A Program Of Study Or Course, Similar To A Trophy Awarded To The Winner Of A Sports Competition.

B. Athlete

C. Winning

D. Prize

Necklace' Is Related To 'Jewellery' In The Same Way As 'Shirt' Is Related To

- A. Cloth
- B. Cotton
- C. Apparel
- D. Thread

Necklace' Is Related To 'Jewellery' In The Same Way As 'Shirt' Is Related To

- A. Cloth
- B. Cotton
- C. Apparel**
- D. Thread



Choose Word Which Is Least Like The Other Words In The Group

- A. Ladder
- B. Staircase
- C. Bridge
- D. Escalator

Choose Word Which Is Least Like The Other Words In The Group

- A. Ladder
- B. Staircase
- C. Bridge**
- D. Escalator

- Q) Choose the word which is different from the rest.
- (A) Physics
 - (B) Chemistry
 - (C) Geography
 - (D) Botany

- Q) Choose the word which is different from the rest.
- (A) Physics
 - (B) Chemistry
 - (C) Geography**
 - (D) Botany

- Q) (A) February
(B) March
(C) July
(D) December

- Q) **(A) February**
(B) March
(C) July
(D) December

- Q) (A) Diagonal
(B) Tangent
(C) Diameter
(D) Radius

- Q) **(A) Diagonal**
(B) Tangent
(C) Diameter
(D) Radius



Which One Of Following Words Is Not A Part Of Group Formed By Remaining Words.

- A. Name
- B. Game
- C. Fame
- D. Shame

Which One Of Following Words Is Not A Part Of Group Formed By Remaining Words.

A. Name

This Is The Only Word Which Has **5 Letters** While The Remaining Words Have 4 Letters And Hence Options (A), (B), & (C) Form A Group Separating Out Option (D).

B. Game

C. Fame

D. Shame

Find Out The Number Which Does Not Suit In The Group.

A. 7842

B. 8952

C. 7122

D. 7722

Find Out The Number Which Does Not Suit In The Group.

A. 7842

B. 8952

C. 7122

D. 7722

Option (B) Is The Correct Answer As Except Option (B)
All Other Options Start With 7 & End With 2.

Which Of The Following Animals Does Not Fit Into Group Formed By Remaining Four Animals

- A. Cat
- B. Dog
- C. Tiger
- D. Octopus

Which Of The Following Animals Does Not Fit Into Group Formed By Remaining Four Animals

A. Cat

B. Dog

C. Tiger

D. Octopus

Option (D) Is The Correct Option As This Is The Only Animal Out Of Given Options Which Is A Water Animal. Rest Of The Options Are Land Animals.

Choose The Odd One Out

- A. Food : Hunger
- B. Water : Thirst
- C. Air : Suffocation
- D. Talent : Education

Choose The Odd One Out

A. Food : Hunger

B. Water : Thirst

C. Air : Suffocation

D. Talent : Education

Lack Of First One Causes Second One



Choose The Odd One Out

- A. Volume
- B. Size
- C. Large
- D. Shape

Choose The Odd One Out

A. Volume

B. Size

'Large' Is An Adjective Whereas Others Are Noun.

C. Large

D. Shape

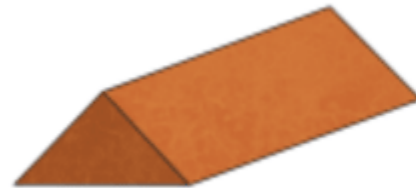

Choose The Odd One Out

- A. Nephrology
- B. Entomology
- C. Astrology
- D. Mycology

Choose The Odd One Out

A. Nephrology

B. Entomology

C. Astrology

D. Mycology

All Except Astrology Are Concerned With Biology.

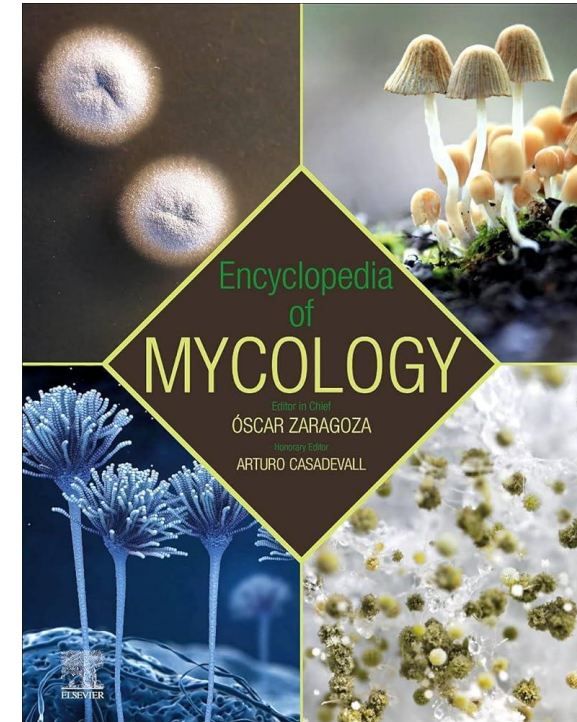
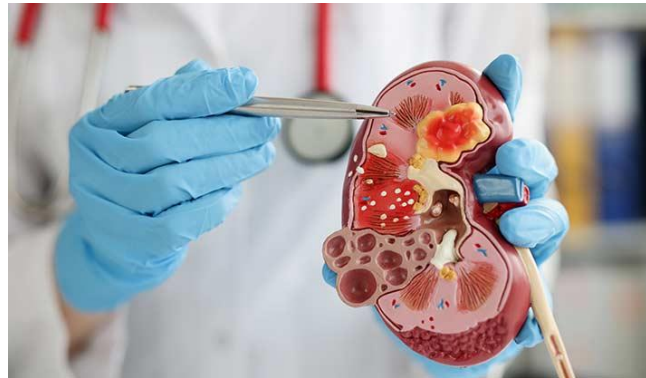

**Pick Out Word In Each Of Following Questions That Is Different.
Rice, Wheat, Barley, Millets, Gram**

- A. Wheat
- B. Barley
- C. Millets
- D. Gram

Pick Out Word In Each Of Following Questions That Is Different. Rice, Wheat, Barley, Millets, Gram

- A. Wheat
- B. Barley
- C. Millets**
- D. Gram



Choose The Odd One Out

- A. Tutor
- B. Principal
- C. Pupil
- D. Professor

Choose The Odd One Out

A. Tutor

B. Principal

C. Pupil

D. Professor

Choose The Odd One Out

A. 3215

B. 9309

C. 4721

D. 2850

Choose The Odd One Out

A. 3215

B. 9309

C. 4721

D. 2850

Choose The Odd One Out

A. R5A1T6

B. B2A1D4

C. C3E5A1

D. H8B2D4

Choose The Odd One Out

A. R5A1T6

B. B2A1D4

C. C3E5A1

D. H8B2D4

		Latter	Position
B2A1D4	→	A	1
		B	2
		D	4
C3E5A1	→	C	3
		E	5
		A	1
H8B2D4	→	H	8
		B	2
		D	4

Hence, wrong term is R5A1T6.

Choose The Odd One Out

- A. Open & Close
- B. Hate & Dislike
- C. Rise & Fall
- D. Go & Come

Choose The Odd One Out

A. Open & Close

B. Hate & Dislike

C. Rise & Fall

D. Go & Come

School, Waspish, Pout, Frown, Sulk

- A. School
- B. Waspish
- C. Pout
- D. Sulk

School, Waspish, Pout, Frown, Sulk

A. School

B. Waspish

C. Pout

D. Sulk



Which Of The Following Is The Next Term Of Series Given Below

4, 6, 9, 13,

(A) 17

(B) 18

(C) 19

(D) 20

Which Of The Following Is The Next Term Of Series Given Below

4, 6, 9, 13,

(A) 17

(B) 18

(C) 19

(D) 20

(b) $4 \quad 6 \quad 9 \quad 13 \quad \boxed{18}$ Correct answer
+2 +3 +4 +5

What Will Come In Place Of Question Mark In The Following Series?

79, 87, ? , 89, 83

A. 80

B. 81

C. 82

D. 88

What Will Come In Place Of Question Mark In The Following Series?

79, 87, ? , 89, 83

A. 80

B. 81

C. 82

D. 88

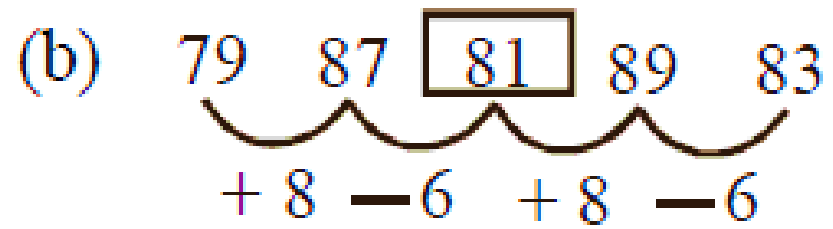

Find The Wrong Term In The Series

3, 8, 15, 24, 34, 48, 63.

A. 15

B. 24

C. 34

D. 63

Find The Wrong Term In The Series

3, 8, 15, 24, 34, 48, 63.

A. 15

B. 24

C. 34

D. 63

$$2^2 - 1, 3^2 - 1, 4^2 - 1, 5^2 - 1, 6^2 - 1$$

Complete The Series

Z, L, X, J, V, H, T, F, __, _

A. D, R

B. R, D

C. D, D

D. R, R

Complete The Series

Z, L, X, J, V, H, T, F, __, _

A. D, R

B. R, D

C. D, D

D. R, R

(b) The given sequence consists of two series

(i) Z, X, V, T, __

(ii) L, J, H, F, __. Both consisting of alternate letters in the reverse order.

∴ Next term of (i) series = R, and

Next term of (ii) series = D

Which Sequence Of Letters When Placed At The Blanks One After Another Will Complete The Given Letter Series

b a a b – a b a – b b a – –

- A. bbaa
- B. aaaa
- C. Abab
- D. baba

Which Sequence Of Letters When Placed At The Blanks One After Another Will Complete The Given Letter Series

b a a b – a b a – b b a – –

A. bbaa

B. aaaa

C. Abab

D. **baba**

b a a b b a / b a a b b a / b a.

AZ, CX, FU,

A. IR

B. IV

C. JQ

D. KP

AZ, CX, FU,

A. IR

B. IV

C. JQ

D. KP

Alphabet	Opposite	Learn It
A	Z	AZHAR
B	Y	BOY
C	X	COX
D	W	DOWN
E	V	EVENING
F	U	FUN
G	T	G.T. ROAD
H	S	HIGH SCHOOL
I	R	IRAN
J	Q	JAQ
K	P	K.P. SIR
L	O	LOVE
M	N	MAN

EJO, TYD, INS, XCH, ?

A. NRW

B. MRW

C. MSX

D. NSX

EJO, TYD, INS, XCH, ?

- A. NRW
- B. MRW**
- C. MSX
- D. NSX

A	B	C	D
E	F	G	H
I	J	K	L
M	N	O	P
Q	R	S	T
U	V	W	X
	Y	Z	

PrintableParadise.com

There Is A Gap Of Four Letters Between First And Second, Second And Third Letter Of Each Term. Also There Is A Gap Of 4 Letters Between The Last Letter Of A Term And The First Letter Of The Next Term.

DCXW, FEVU, HGTS,

A. LKPO

B. ABYZ

C. JIRQ

D. LMRS

DCXW, FEVU, HGTS,

- A. LKPO
- B. ABYZ
- C. JIRQ**
- D. LMRS

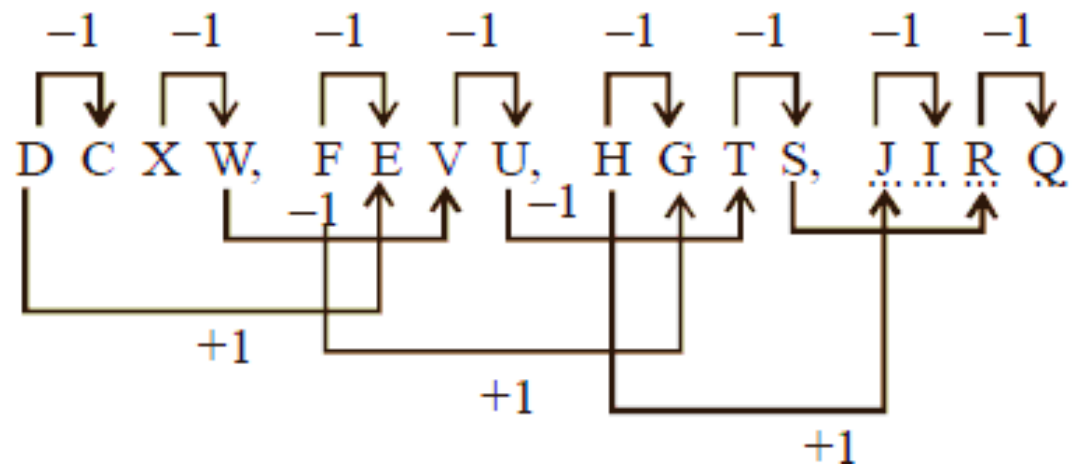

A B C D
E F G H
I J K L
M N O P
Q R S T
U V W X
Y Z

C, e, G, i, K....

A. O, K

B. m, O

C. k, M

D. M, k

C, e, G, i, K....

A. O, K

B. m, O

C. k, M

D. M, k

A L W B M X C N

A. V

B. W

C. Y

D. X

A L W B M X C N

- A. V
- B. W
- C. Y**
- D. X

There are three alternate series.

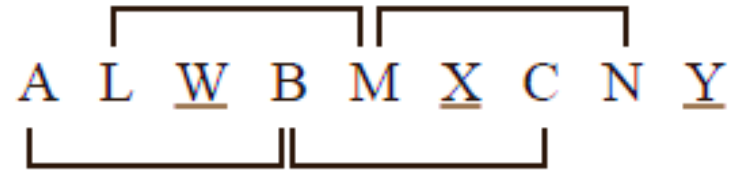

LAZ, NEX, PIV, ?

- A. SLS
- B. QNS
- C. RMT
- D. RMS

LAZ, NEX, PIV, ?

- A. SLS
- B. QNS
- C. RMT**
- D. RMS

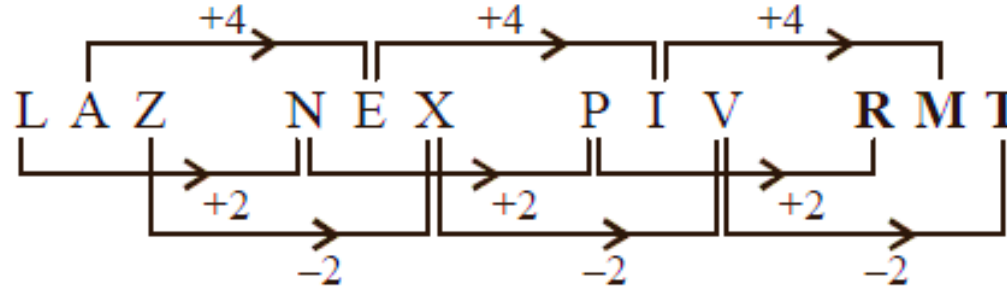

Maha Marathon 1 (Reasoning) - AFCAT 2 2024 - Live Class

In the number **53261489**, if first and fifth digits interchange their positions, second and sixth digits interchange their positions and further changes keep going on in the same manner, then which digit will be 6th from the right in the rearrangement?

- a) 8
- b) 6
- c) 4
- d) 2

In the number **53261489**, if first and fifth digits interchange their positions, second and sixth digits interchange their positions and further changes keep going on in the same manner, then which digit will be 6th from the right in the rearrangement?

a) 8

b) 6

c) 4

d) 2

Ans(a)

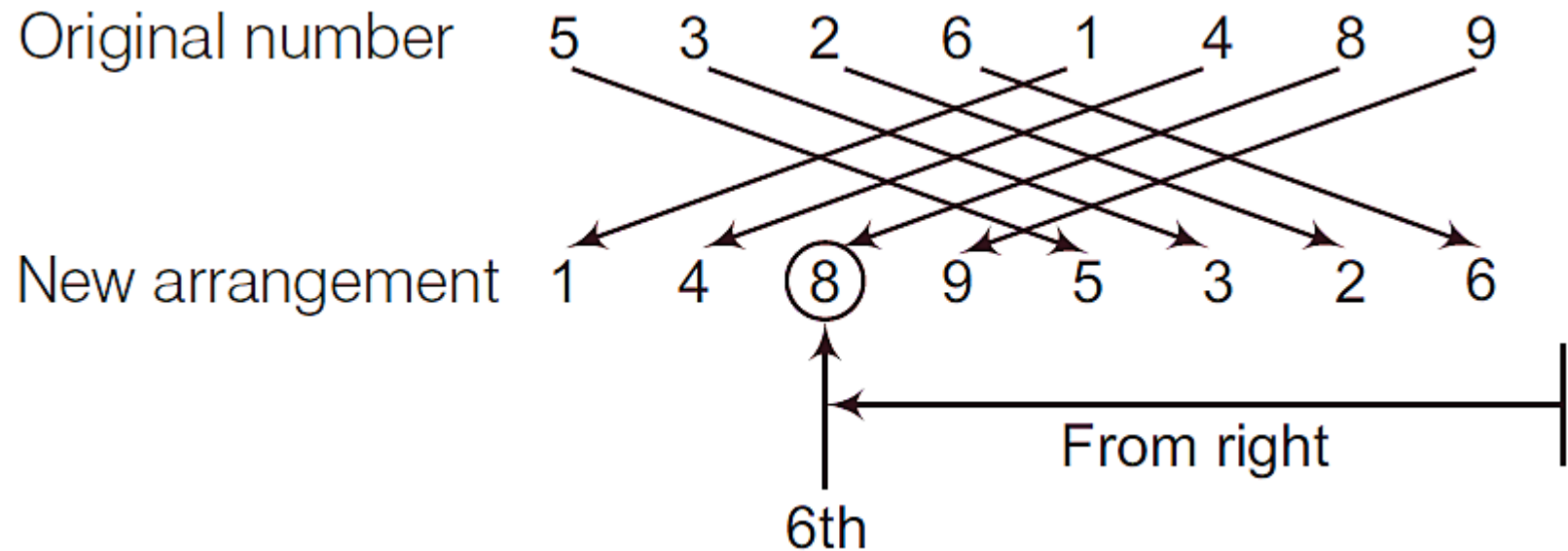

Maha Marathon 1 (Reasoning) - AFCAT 2 2024 - Live Class

Which number has come maximum time in the following number series?

5 4 3 3 5 4 8 8 3 2 5 3 6 5 5

- a) 5
- b) 4
- c) 3
- d) 2

Maha Marathon 1 (Reasoning) - AFCAT 2 2024 - Live Class

Which number has come maximum time in the following number series?

5 4 3 3 5 4 8 8 3 2 5 3 6 5 5

a) 5

b) 4

c) 3

d) 2

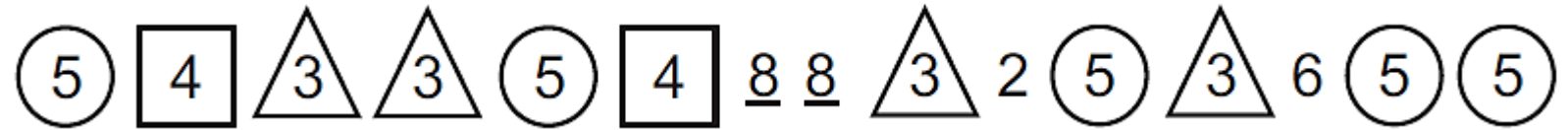

Ans(a)

Maha Marathon 1 (Reasoning) - AFCAT 2 2024 - Live Class

Vinay is taller than Hansika, Hansika is taller than Abhay, Aalok is taller than Ashok and Ashok is taller than Vinay. Who is the shortest in the group?

- a) Aalok
- b) Ashok
- c) Hansika
- d) Abhay

Maha Marathon 1 (Reasoning) - AFCAT 2 2024 - Live Class

Vinay is taller than Hansika, Hansika is taller than Abhay, Aalok is taller than Ashok and Ashok is taller than Vinay. Who is the shortest in the group?

- a) Aalok
- b) Ashok
- c) Hansika
- d) Abhay**

Ans(d)

Maha Marathon 1 (Reasoning) - AFCAT 2 2024 - Live Class

In class of 45 students rank of Ayush is 15 from top, then rank of Ayush from bottom is

- a) 30
- b) 32
- c) 31
- d) 35

Maha Marathon 1 (Reasoning) - AFCAT 2 2024 - Live Class

In class of 45 students rank of Ayush is 15 from top, then rank of Ayush from bottom is

- a) 30
- b) 32
- c) 31**
- d) 35

Ans(c)

Sita is elder than Swapna. Lavanya is elder than Swapna but younger than Sita. Suvarna is younger than both Hari and Swapna, Swapna is elder than Hari. Who is the youngest?

- (a) Sita
- (b) Lavanya
- (c) Suvarna
- (d) Hari

Sita is elder than Swapna. Lavanya is elder than Swapna but younger than Sita. Suvarna is younger than both Hari and Swapna, Swapna is elder than Hari. Who is the youngest?

- (a) Sita
- (b) Lavanya
- (c) Suvarna
- (d) Hari

Ans: (c)

In a row of girls, Kamala is 9th from the left and Veena is 16th from the right. If they interchange their positions, Kamala becomes 25th from the left. How many girls are there in the row?

- (a) 34
- (b) 36
- (c) 40
- (d) 41

In a row of girls, Kamala is 9th from the left and Veena is 16th from the right. If they interchange their positions, Kamala becomes 25th from the left. How many girls are there in the row?

- (a) 34
- (b) 36
- (c) 40
- (d) 41

Ans: (c)

The product of the second and the third digit in which of the following numbers is the second highest?

821 547 452 935 368

(a) 547

(b) 935

(c) 368

(d) 452

The product of the second and the third digit in which of the following numbers is the second highest?

821 547 452 935 368

(a) 547

(b) 935

(c) 368

(d) 452

Ans: (a)

In a group of five districts, Akbarpur is smaller than Fatehpur, Dhanbad is bigger than Palamu and Bara Banki is bigger than Fatehpur but not as big as Palamu. Which district is the biggest?

- (a) Akbarpur
- (b) Fatehpur
- (c) Dhanbad
- (d) Palamu

In a group of five districts, Akbarpur is smaller than Fatehpur, Dhanbad is bigger than Palamu and Bara Banki is bigger than Fatehpur but not as big as Palamu. Which district is the biggest?

- (a) Akbarpur
- (b) Fatehpur
- (c) Dhanbad
- (d) Palamu

Ans: (c)

Satish read a book on Sunday. Sudha read that book one day prior to Anil but 4 days after Satish. On which day did Anil read the book?

- (a) Friday
- (b) Thursday
- (c) Tuesday
- (d) Saturday

Satish read a book on Sunday. Sudha read that book one day prior to Anil but 4 days after Satish. On which day did Anil read the book?

- (a) Friday
- (b) Thursday
- (c) Tuesday
- (d) Saturday

Ans: (a)

Which Of Following Letter Is 7th To Right Of 13th Letter From Left In A Forward Alphabet Series

- A. R
- B. T
- C. V
- D. W

Which Of Following Letter Is 7th To Right Of 13th Letter From Left In A Forward Alphabet Series

A. R



13th letter from left



C. V

D. W

B. T

Which Of Following Words Will Come 2nd In The Dictionary

- A. Name
- B. Shame
- C. Fame
- D. Came

Which Of Following Words Will Come 2nd In The Dictionary

- A. Name
- B. Shame
- C. Fame**
- D. Came

How Many Such Pairs Of Letters Are There In Word 'IDEAL' Each Of Which Has As Many Letters Between Them In Word As In English Alphabet

- A. Nil
- B. One
- C. Two
- D. Four

How Many Such Pairs Of Letters Are There In Word 'IDEAL' Each Of Which Has As Many Letters Between Them In Word As In English Alphabet

A. Nil

B. One

C. Two

D. Four

(b) 9 4 5 1 12
 I D E A L

⇒ DE

Here, we observe that in the above word, only 'DE' is a letter pair each of which has as many letters between them in the word as in the English alphabet. Hence, number of required letter pair is One

How Many Three - Letter Meaningful Words Can Be Formed From The Word TEAR Beginning With 'A' Without Repeating Any Letter Within That Word?

- A. One
- B. Three
- C. Five
- D. Two
- E. None of these

How Many Three - Letter Meaningful Words Can Be Formed From The Word TEAR Beginning With 'A' Without Repeating Any Letter Within That Word?

A. One

B. Three

C. Five

D. Two

E. None of these

Meaningful words are : ARE, ART, ATE

How Many Pairs Of Letters Are There In Word 'TABLE' Each Of Which Has As Many Letters Between Them In Word, As They Have Between Them In English Alphabet

- A. Three
- B. Two
- C. One
- D. Four

How Many Pairs Of Letters Are There In Word 'TABLE' Each Of Which Has As Many Letters Between Them In Word, As They Have Between Them In English Alphabet

A. Three

B. Two

C. One

D. Four

From Given Alternatives, Select Word Which Can Be Formed Using Letters Of Given Word. REMEMBERING

A. NEGRO

B. AGREE

C. RAIN

D. GREEN

From Given Alternatives, Select Word Which Can Be Formed Using Letters Of Given Word. REMEMBERING

A. NEGRO

B. AGREE

C. RAIN

D. GREEN

In This Question, A Word Has Been Given Following By Four Other Words, One Of Which Can Not Be Formed By Using The Letters Of The Given Word. Find This Word.

NOMENCLATURE

- A. CLEAN
- B. MENTAL
- C. NATURE
- D. RETIRE

In This Question, A Word Has Been Given Following By Four Other Words, One Of Which Can Not Be Formed By Using The Letters Of The Given Word. Find This Word.

NOMENCLATURE

- A. CLEAN
- B. MENTAL
- C. NATURE
- D. RETIRE**

From Given Alternatives Select Word Which Can Be Formed Using The Letters Of The Given Word

STRANGULATION

- A. TRIANGLE
- B. GARLAND
- C. ROASTING
- D. TRAUMA

From Given Alternatives Select Word Which Cannot Be Formed Using The Letters Of The Given Word

STRANGULATION

A. TRIANGLE

B. GARLAND

C. ROASTING

D. TRAUMA

CONTROVERSY

A. RIVER

B. STORY

C. OTHER

D. YOURS

CONTROVERSY

A. RIVER

B. STORY

C. OTHER

D. YOURS

RATIONALISATION

- A. SENSATION
- B. ALTERATION
- C. TRANSITION
- D. INTERNAL

RATIONALISATION

A. SENSATION

B. ALTERATION

C. TRANSITION

D. INTERNAL

Choose The Odd Pair Of Letters From The Given List.

A. PQT

B. DEH

C. UVY

D. IJN

Choose The Odd Pair Of Letters From The Given List.

A. PQT

B. DEH

C. UVY

D. IJN

Option D Has A Three-letter Gap Between The Second And Third Letters, Separating Them From The Rest Of The Letters. The Other Three Options Have A Two-letter Gap Between The Second And Third Letters.

Choose The Odd Word From The Given List.

- A. C.V. Raman
- B. B. Acharya Kripalani
- C. C. Radhakrishnan
- D. D. Rajagopalachari

Choose The Odd Word From The Given List.

A. C.V. Raman

B. B. Acharya Kripalani

C. C. Radhakrishnan

D. D. Rajagopalachari

Choose The Unusual Word From The Below List.

- A. Granite
- B. Basalt
- C. Pumice
- D. Sandstone

Choose The Unusual Word From The Below List.

A. Granite

B. Basalt

C. Pumice

D. Sandstone

Sandstone Is A Sedimentary Rock, While The Others Are Igneous Rocks Created By The Cooling Of Magma.

Choose The Word Which Is Different From The Rest

- A. Cap
- B. Turban
- C. Helmet
- D. Veil

Choose The Word Which Is Different From The Rest

A. Cap

B. Turban

C. Helmet

D. Veil

Pick The Odd Word From The Given List.

A. Lamprey

B. Rhea

C. Bass

D. Trout

Pick The Odd Word From The Given List.

A. Lamprey

B. Rhea

All The Others Except Rhea, Are Names Of Fishes.

C. Bass





D. Trout

AFCAT Exam Online Coaching 2024

AFCAT 2024: 📺 Live Classes ▶ In-Depth Lectures 📄 Study Notes 📄 Mock Tests 📅 Current Affairs ✂ Defence Current Affairs.

★★★★★ 5.0 (147)

Content 20

-  AFCAT 2 2024 Live Batch - 1
Course • 221 Lessons 1 Trial
-  AFCAT 1 2024 Live Batch - 2
Course • 148 Lessons 2 Trials
-  AFCAT 1 2024 Live Batch - 1
Course • 376 Lessons 1 Trial
-  AFCAT 2 2023 Live Batch
Course • 924 Lessons 3 Trials

AFCAT

Air Force Common Admission Test

- 📺 Live Classes
- ▶ In-Depth Lectures
- 📄 Study Notes
- 📄 Mock Tests
- 📅 Current Affairs
- ✂ Defence Current Affairs

USE CODE: **"WARRIOR10"**
FOR 10% OFF ON NDA COURSE



🕒 365 Days validity

₹ 5,999 ~~₹ 7,999~~ 25% OFF

[BUY BUNDLE](#) [START A FREE TRIAL](#)

What's included

- 📄 20 Courses

Other Pricing Plans

Only for AFCAT 2 2024 🔗 Details

180 Days Validity

₹4,999 ~~₹5,999~~ 17% off

[BUY NOW](#)

Choose from our Courses



SSB INTERVIEW
ONLINE COURSE

USE CODE: **WARRIOR10**
FOR 10% OFF ON SSB COURSE

SSB Interview Online Course
2022 - 2023

19 courses ₹9999 **₹6999**



USE CODE: **WARRIOR10**
FOR 10% OFF ON NDA COURSE

NDA Exam Online Course
2023 - 2024

24 courses ₹7999 **₹5999**



USE CODE: **WARRIOR10**
FOR 10% OFF ON OTA COURSE

CDS OTA Exam Online Course
2023 - 2024

23 courses ₹7499 **₹5499**



USE CODE: **WARRIOR10**
FOR 10% OFF ON CDS COURSE

CDS Exam Online Course
2023 - 2024

24 courses ₹7999 **₹5999**



USE CODE: **WARRIOR10**
FOR 10% OFF ON AFCAT COURSE

AFCAT Exam Online Course
2023 - 2024

24 courses ₹7999 **₹5999**



USE CODE: **WARRIOR10**
FOR 10% OFF ON TA COURSE

Territorial Army Exam
Online Course 2022 -2023

26 courses ₹4999 **₹3999**



USE CODE: **WARRIOR10**
FOR 10% OFF ON ACC COURSE

ACC Exam Online Course
2023 - 2024

27 courses ₹5999 **₹4999**



USE CODE: **WARRIOR10**
FOR 10% OFF ON MNS COURSE

MNS Exam Online Course
2023 - 2024

24 courses ₹4999 **₹3999**

[View All](#)

India's Most Popular Portal for Defence Exam Preparation

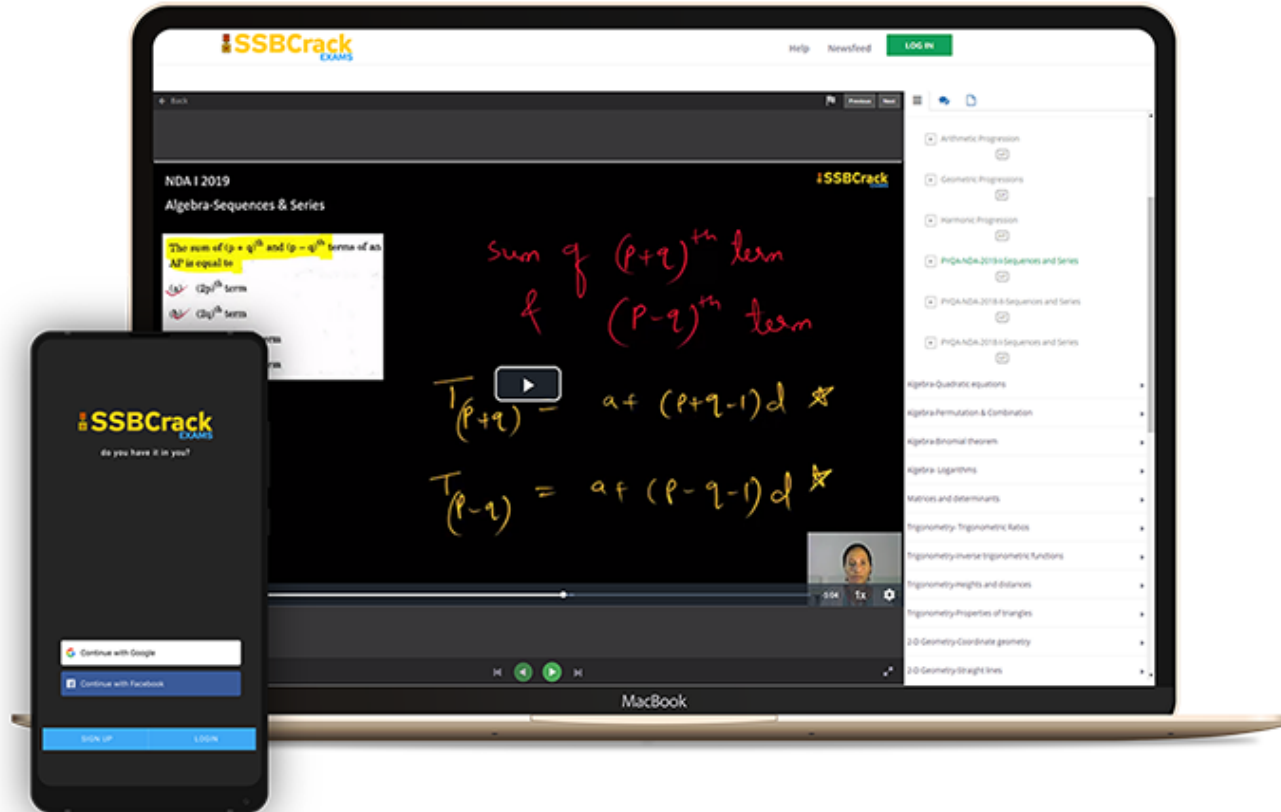

www.ssbscrackexams.com

CODE: WARRIOR10

get an extra **10%** off on all courses





AFCAT 2 2024

MAHA MARATHON #1



COMPLETE REVISION

5TH AUG 2024
1 PM TO 5 PM



LIVE CLASS



AFCAT 2 2024

MAHA MARATHON

05 TO 08 AUG 2024

01 PM TO 02 PM

REASONING - RUBY MA'AM

02 PM TO 03 PM

ENGLISH - ANURADHA MA'AM

03 PM TO 04 PM

STATIC GK - DIVYANSHU SIR

04 PM TO 05 PM

MATHS - NAVJYOTI SIR

 CALL US: 080-69185400

 GET IT ON
Google Play

DOWNLOAD
THE APP NOW







AFCAT Exam Online Coaching 2024

AFCAT 2024: 📺 Live Classes 🎥 In-Depth Lectures 📄 Study Notes 📄 Mock Tests 📅 Current Affairs ✂ Defence Current Affairs.

★★★★★ 5.0 (147)

Content 20

-  AFCAT 2 2024 Live Batch - 1
Course • 221 Lessons 1 Trial
-  AFCAT 1 2024 Live Batch - 2
Course • 148 Lessons 2 Trials
-  AFCAT 1 2024 Live Batch - 1
Course • 376 Lessons 1 Trial
-  AFCAT 2 2023 Live Batch
Course • 924 Lessons 3 Trials



AFCAT
Air Force Common Admission Test

- 📺 Live Classes
- 🎥 In-Depth Lectures
- 📄 Study Notes
- 📄 Mock Tests
- 📄 Current Affairs
- ✂ Defence Current Affairs.

USE CODE: **"WARRIOR10"**
FOR 10% OFF ON NDA COURSE

🕒 365 Days validity

₹ 5,999 ~~₹ 7,999~~ 25% OFF

[BUY BUNDLE](#) [START A FREE TRIAL](#)

What's included

📄 20 Courses

Other Pricing Plans

Only for AFCAT 2 2024 🔗 Details

180 Days Validity

₹4,999 ~~₹5,999~~ 17% off

[BUY NOW](#)

Choose from our Courses



SSB INTERVIEW
ONLINE COURSE

USE CODE: **WARRIOR10**
FOR 10% OFF ON SSB COURSE

SSB Interview Online Course
2022 - 2023

19 courses ₹9999 **₹6999**



USE CODE: **WARRIOR10**
FOR 10% OFF ON NDA COURSE

NDA Exam Online Course
2023 - 2024

24 courses ₹7999 **₹5999**



USE CODE: **WARRIOR10**
FOR 10% OFF ON OTA COURSE

CDS OTA Exam Online Course
2023 - 2024

23 courses ₹7499 **₹5499**



USE CODE: **WARRIOR10**
FOR 10% OFF ON CDS COURSE

CDS Exam Online Course
2023 - 2024

24 courses ₹7999 **₹5999**



USE CODE: **WARRIOR10**
FOR 10% OFF ON AFCAT COURSE

AFCAT Exam Online Course
2023 - 2024

24 courses ₹7999 **₹5999**



USE CODE: **WARRIOR10**
FOR 10% OFF ON TA COURSE

Territorial Army Exam
Online Course 2022 -2023

26 courses ₹4999 **₹3999**



USE CODE: **WARRIOR10**
FOR 10% OFF ON ACC COURSE

ACC Exam Online Course
2023 - 2024

27 courses ₹5999 **₹4999**



USE CODE: **WARRIOR10**
FOR 10% OFF ON MNS COURSE

MNS Exam Online Course
2023 - 2024

24 courses ₹4999 **₹3999**

[View All](#)

India's Most Popular Portal for Defence Exam Preparation

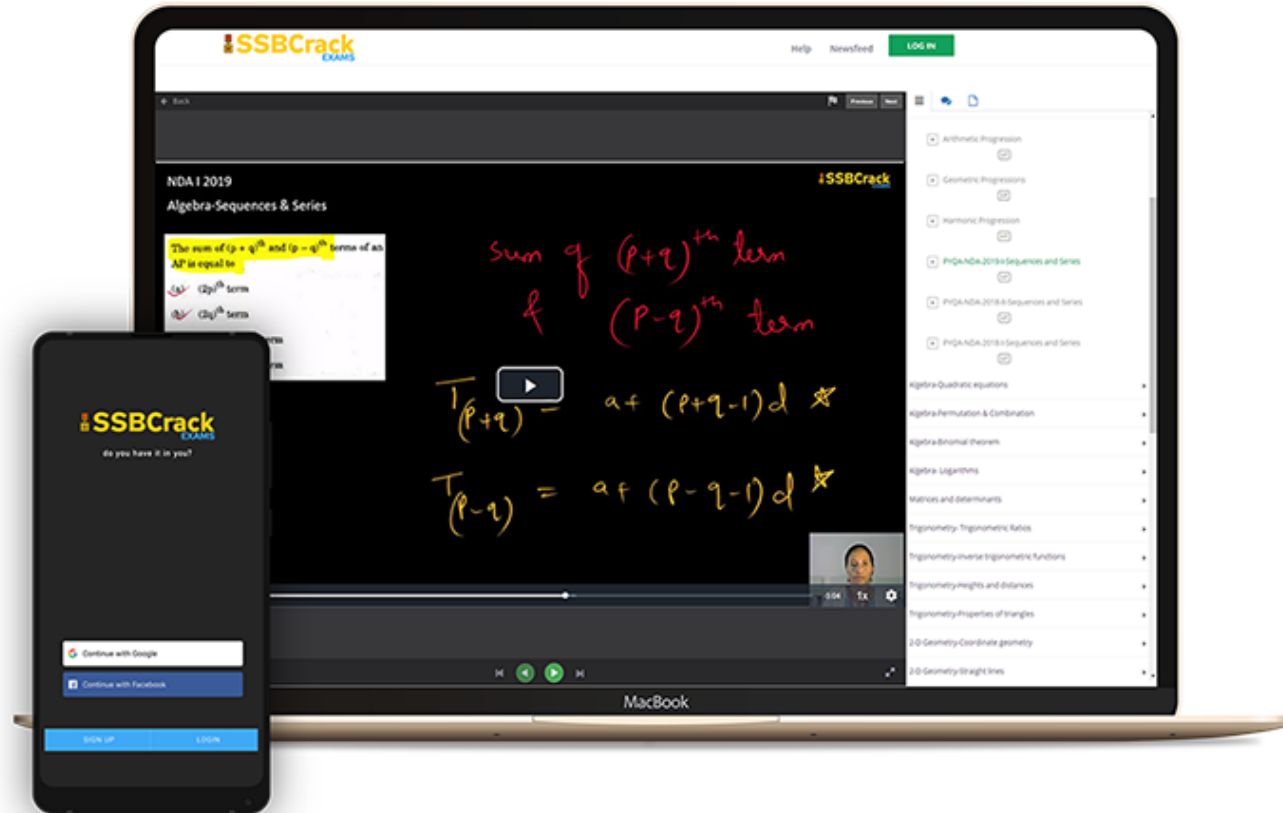

www.ssbcrackexams.com

CODE: WARRIOR10

get an extra **10%** off on all courses



DIRECTIONS

In each of the question part, find out which part has an error. If there is no mistake, the answer is 'No error'.

Q. He is representing (a)/ my constituency (b)/ for the last five years. (c)/ No error (d)

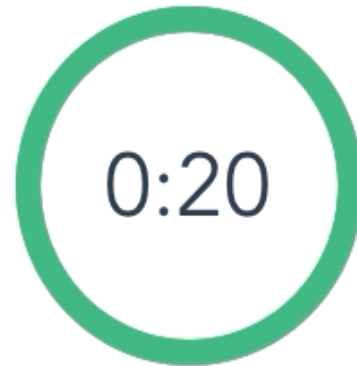

Q. He is representing (a)/ my constituency (b)/ for the last five years. (c)/ No error (d)

Ans. (a)

Q. I am waiting (a)/ for my friend (b)/ since this morning. (c)/ No error (d)

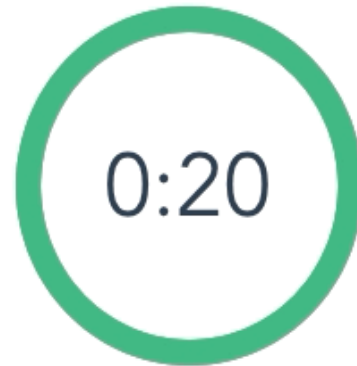

Q. I am waiting (a)/ for my friend (b)/ since this morning. (c)/ No error (d)

Ans. (a)

Q. My detailed statement (a)/ is respectively (b)/ submitted. (c)/ No error (d)

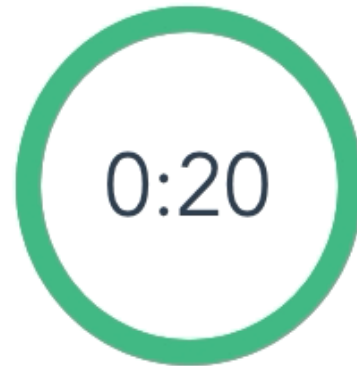

Q. My detailed statement (a)/ is respectively (b)/ submitted. (c)/ No error (d)

Ans. (b)

Q. Speech was given (a)/ to man to (b)/ conseal his thoughts. (c)/ No Error (d)

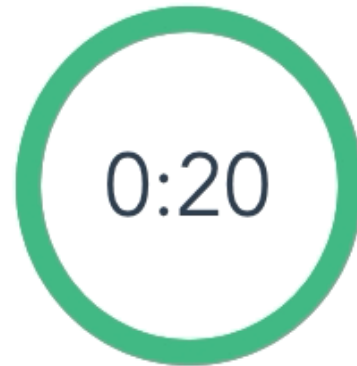

Q. Speech was given (a)/ to man to (b)/ conseal his thoughts. (c)/ No Error (d)

Ans. (c)

Q. The Management Committee (a)/ was divided (b)/ in their opinion. (c)/ No Error (d)

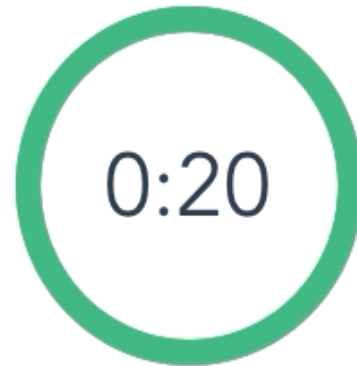

Q. The Management Committee (a)/ was divided (b)/ in their opinion. (c)/ No Error (d)

Ans. (b)

Q. It is not (a)/ such a pretty place (b)/ that I had expected. (c)/ No Error (d)

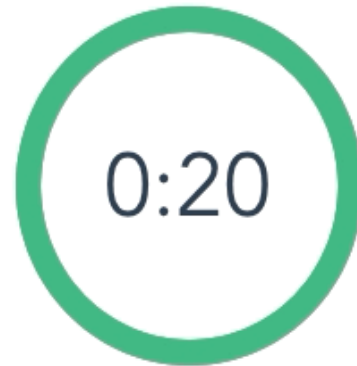

Q. It is not (a)/ such a pretty place (b)/ that I had expected. (c)/ No Error (d)

Ans. (c)

DIRECTIONS

In the following questions, choose the correct synonym.

Q. Vociferous

(a) Violent

(b) Loud

(c) Secret

(d) True

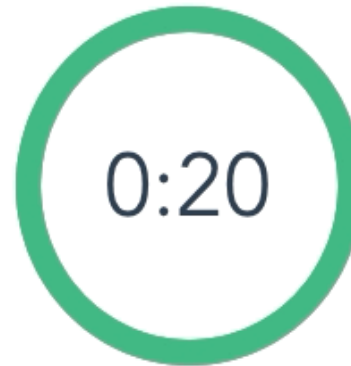

Q. Vociferous

(a) Violent

(b) Loud

(c) Secret

(d) True

Ans. (b)

Q. Perspicuous

(a) Relevant

(b) Precise

(c) Brief

(d) Clear

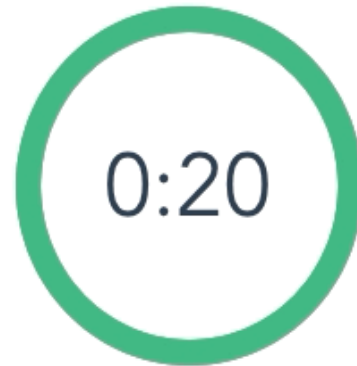

Q. Perspicuous

(a) Relevant

(b) Precise

(c) Brief

(d) Clear

Ans. (d)

Q. Prodigal

- (a) Exclusive
- (b) Productive
- (c) Lavish
- (d) Carefree



Q. Prodigal

- (a) Exclusive
- (b) Productive
- (c) Lavish
- (d) Carefree

Ans. (c)

Q. Intrepid

(a) Hesitant

(b) Fearless

(c) Extrovert

(d) Rash

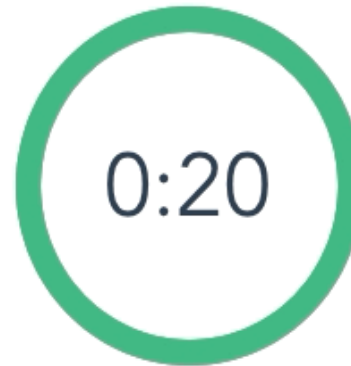

Q. Intrepid

- (a) Hesitant
- (b) Fearless
- (c) Extrovert
- (d) Rash

Ans. (b)

Q. Infamy

(a) Notoriety

(b) Glory

(c) Integrity

(d) Familiarity

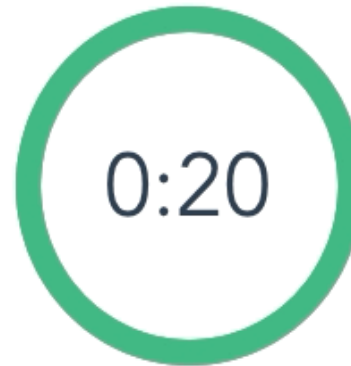

Q. Infamy

(a) Notoriety

(b) Glory

(c) Integrity

(d) Familiarity

Ans. (a)

Q. Barren

(a) Good

(b) Wholesome

(c) Unproductive

(d) Profitable

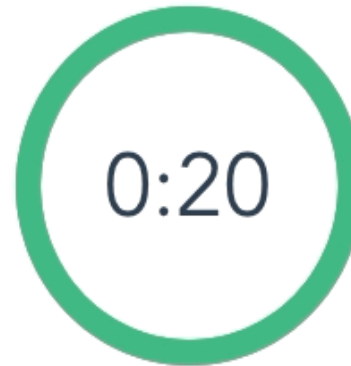

Q. Barren

(a) Good

(b) Wholesome

(c) Unproductive

(d) Profitable

Ans. (c)

Q. Accrue

(a) Accumulate

(b) Accommodate

(c) Loss

(d) Suffice

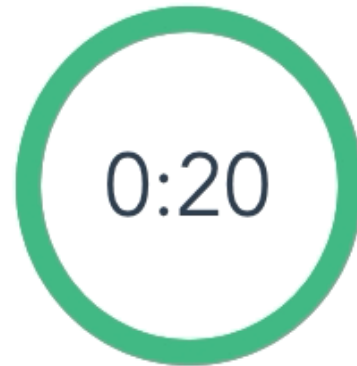

Q. Accrue

(a) Accumulate

(b) Accommodate

(c) Loss

(d) Suffice

Ans. (a)

DIRECTIONS

In the following questions, choose the correct antonym.

Q. Supplicate

(a) Short of supply

(b) To be arrogant

(c) To be tolerant

(d) To fall on lean days

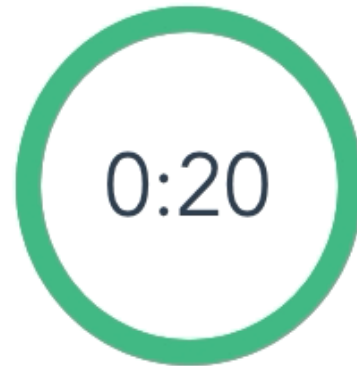

Q. Supplicate

(a) Short of supply

(b) To be arrogant

(c) To be tolerant

(d) To fall on lean days

Ans. (b)

Q. Vacillate

(a) amplify

(b) stimulate

(c) consistent

(d) eradicate

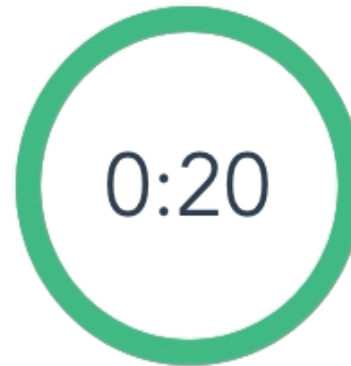

Q. Vacillate

(a) amplify

(b) stimulate

(c) consistent

(d) eradicate

Ans. (c)

Q. Indict

- (a) condemn
- (b) reprimand
- (c) acquit
- (d) allege

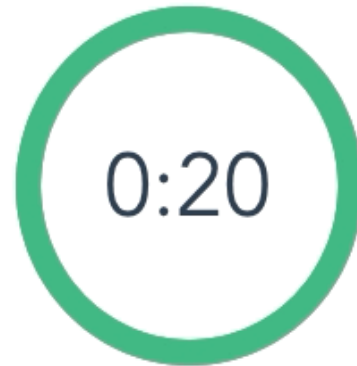

Q. Indict

- (a) condemn
- (b) reprimand
- (c) acquit
- (d) allege

Ans. (c)

Q. Procrastinate

(a) To be prompt

(b) To adjudicate

(c) To teach

(d) To help others

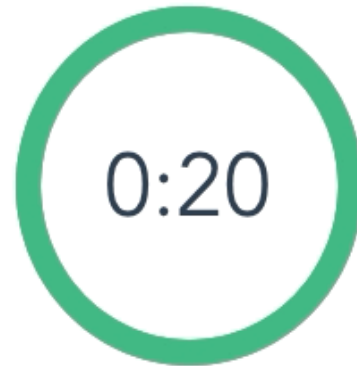

Q. Procrastinate

(a) To be prompt

(b) To adjudicate

(c) To teach

(d) To help others

Ans. (a)

Q. Diminutive

(a) enlarged

(b) bright

(c) small

(d) admonitory

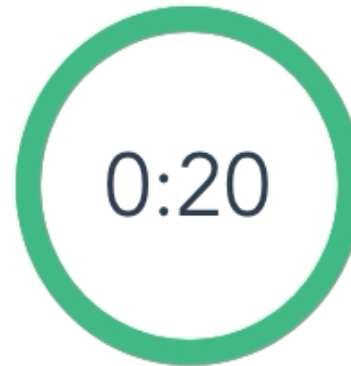

Q. Diminutive

(a) enlarged

(b) bright

(c) small

(d) admonitory

Ans. (a)

Q. Verbose

- (a) laconic
- (b) talkative
- (c) vent
- (d) suspense

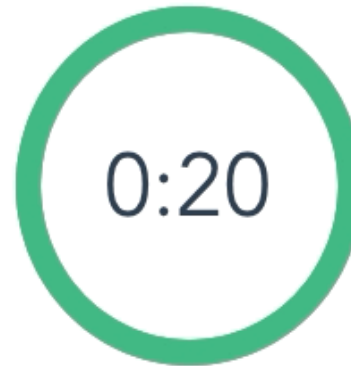

Q. Verbose

- (a) laconic
- (b) talkative
- (c) vent
- (d) suspense

Ans. (a)

Q. Chimerical

(a) numerical

(b) real

(c) obvious

(d) heavenly

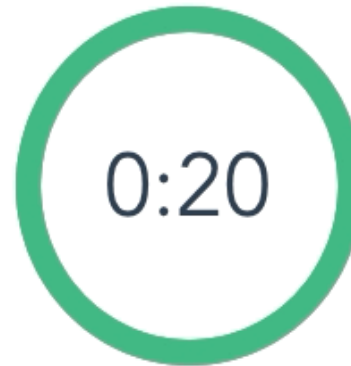

Q. Chimerical

(a) numerical

(b) real

(c) obvious

(d) heavenly

Ans. (b)

DIRECTIONS

Choose the alternative which best expresses the meaning of the Idiom/ Phrase that is your answer.

Q. To smell a rat

- (a) to suspect a trick
- (b) to misunderstand
- (c) to see hidden meaning
- (d) to smell a bad smell

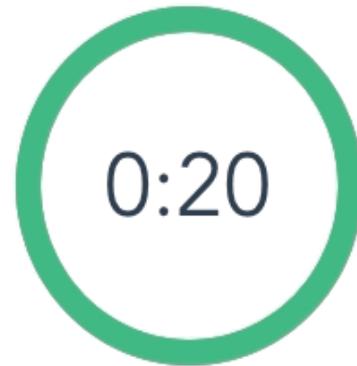

Q. To smell a rat

- (a) to suspect a trick
- (b) to misunderstand
- (c) to see hidden meaning
- (d) to smell a bad smell

Ans. (a)

Q. Child's play

- (a) Childish behaviour
- (b) Meaningless game
- (c) Something very easily done
- (d) Pleasant act



Q. Child's play

- (a) Childish behaviour
- (b) Meaningless game
- (c) Something very easily done
- (d) Pleasant act

Ans. (c)

Q. Putting the cart before the horse

- (a) doing a thing in the wrong way
- (b) doing a thing in the right way
- (c) committing a great crime
- (d) doing things meticulously

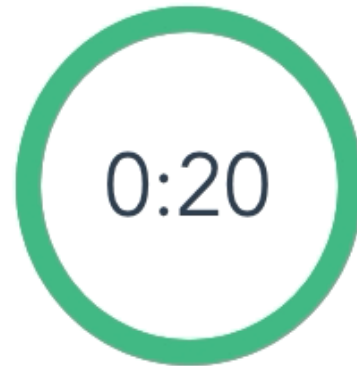

Q. Putting the cart before the horse

- (a) doing a thing in the wrong way
- (b) doing a thing in the right way
- (c) committing a great crime
- (d) doing things meticulously

Ans. (a)

Q. Out of the woods

- (a) To cross the woodland
- (b) To come out of a jungle
- (c) To be out of a danger
- (d) To be made of wood



Q. Out of the woods

- (a) To cross the woodland
- (b) To come out of a jungle
- (c) To be out of a danger
- (d) To be made of wood

Ans. (c)

Q. Egg on

(a) urge

(b) dampen

(c) hinder

(d) discourage

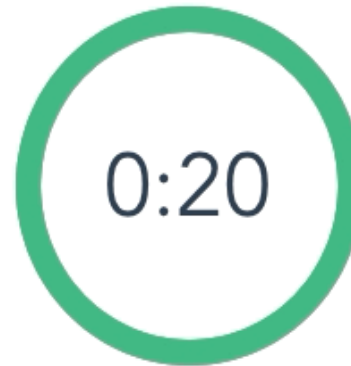

Q. Egg on

(a) urge

(b) dampen

(c) hinder

(d) discourage

Ans. (a)

Q. Paying through the nose

- (a) paying less than necessary
- (b) paying too much
- (c) paying the right amount
- (d) paying reluctantly



Q. Paying through the nose

(a) paying less than necessary

(b) paying too much

(c) paying the right amount

(d) paying reluctantly

Ans. (b)

Q. To show a clean pair of heels

- (a) To hide
- (b) To escape
- (c) To pursue
- (d) To follow

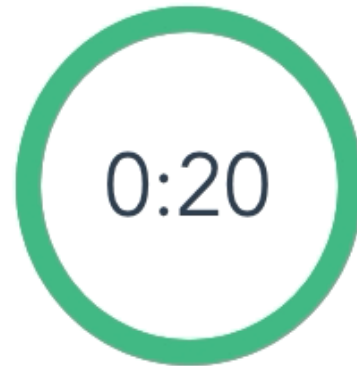

Q. To show a clean pair of heels

- (a) To hide
- (b) To escape
- (c) To pursue
- (d) To follow

Ans. (b)

DIRECTIONS

In the following questions, the sentence given with blank to be filled in with an appropriate word. Select the correct alternative out of the four and indicate it by selecting the appropriate option.

Q. The deserted garden was infested _____ weeds.

(a) for

(b) into

(c) on

(d) with

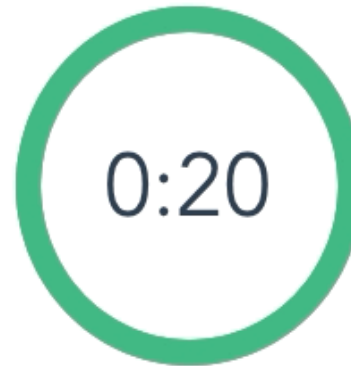

Q. The deserted garden was infested _____ weeds.

(a) for

(b) into

(c) on

(d) with

Ans. (d)

Q. Making pies and cakes _____ Mrs. Reddy's specialty.

(a) are

(b) were

(c) is

(d) has

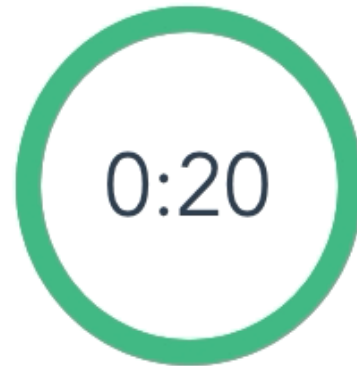

Q. Making pies and cakes _____ Mrs. Reddy's specialty.

(a) are

(b) were

(c) is

(d) has

Ans. (c)

Q. You must _____ your career with all seriousness.

(a) follow

(b) complete

(c) direct

(d) pursue

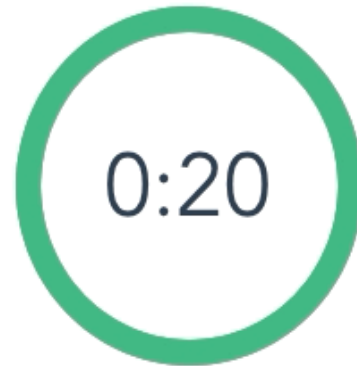

Q. You must _____ your career with all seriousness.

(a) follow

(b) complete

(c) direct

(d) pursue

Ans. (d)

Q. It was customary _____ devotees going to that temple to take a bath in the nearby tank first.

(a) with

(b) on

(c) for

(d) about

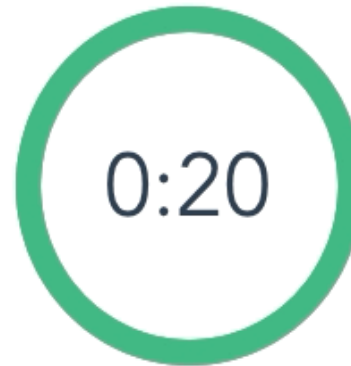

Q. It was customary _____ devotees going to that temple to take a bath in the nearby tank first.

(a) with

(b) on

(c) for

(d) about

Ans. (c)

Q. The teacher warned the students to desist _____ making noise.

(a) from

(b) about

(c) with

(d) by

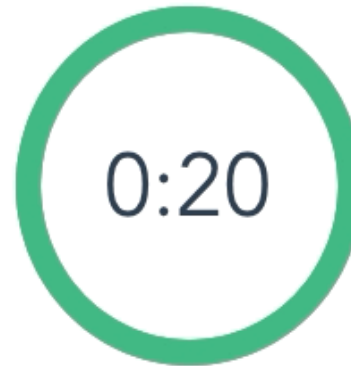

Q. The teacher warned the students to desist _____ making noise.

(a) from

(b) about

(c) with

(d) by

Ans. (a)

Q. I doubt whether the accommodation in that place is adequate _____ our needs.

(a) according to

(b) with

(c) for

(d) against

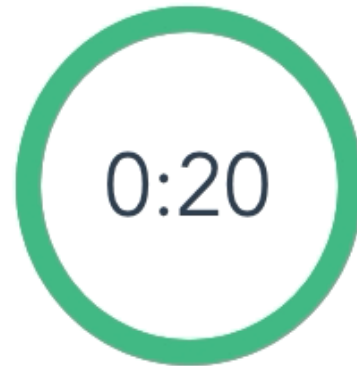

Q. I doubt whether the accommodation in that place is adequate _____ our needs.

(a) according to

(b) with

(c) for

(d) against

Ans. (c)

DIRECTIONS

In these questions, in the following passage some of the words have been left out. Read the passage carefully and choose the correct out of four alternatives.

We know that the average depth of the sea is about two and a half miles, but in a few places it is very deep indeed—over six miles. The air presses upon our bodies with a weight of about fifteen pounds to the square inch at ___(1)___ We are used to this air pressure and ___(2)___ not notice it. In the sea this ___(3)___ is doubled at a depth of thirty-five feet, and it ___(4)___ at this rate for greater depths. In the great deeps off the Philippine Islands, a man would be squeezed and utterly crushed by a pressure of ___(5)___ tons per square inch.

1. (a) sea-water (b) sea-level (c) sea-bed (d) seashore

0:20

We know that the average depth of the sea is about two and a half miles, but in a few places it is very deep indeed—over six miles. The air presses upon our bodies with a weight of about fifteen pounds to the square inch at ___(1)___ We are used to this air pressure and ___(2)___ not notice it. In the sea this ___(3)___ is doubled at a depth of thirty-five feet, and it ___(4)___ at this rate for greater depths. In the great deeps off the Philippine Islands, a man would be squeezed and utterly crushed by a pressure of ___(5)___ tons per square inch.

1. (a) sea-water (b) sea-level (c) sea-bed (d) seashore

Ans. (b)

We know that the average depth of the sea is about two and a half miles, but in a few places it is very deep indeed—over six miles. The air presses upon our bodies with a weight of about fifteen pounds to the square inch at __ (1) __ We are used to this air pressure and __ (2) __ not notice it. In the sea this __ (3) __ is doubled at a depth of thirty-five feet, and it __ (4) __ at this rate for greater depths. In the great deeps off the Philippine Islands, a man would be squeezed and utterly crushed by a pressure of __ (5) __ tons per square inch.

2. (a) do (b) did (c) does (d) have

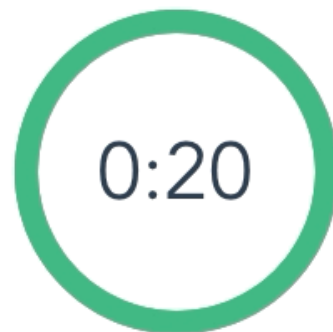

We know that the average depth of the sea is about two and a half miles, but in a few places it is very deep indeed—over six miles. The air presses upon our bodies with a weight of about fifteen pounds to the square inch at ___(1)___ We are used to this air pressure and ___(2)___ not notice it. In the sea this ___(3)___ is doubled at a depth of thirty-five feet, and it ___(4)___ at this rate for greater depths. In the great deeps off the Philippine Islands, a man would be squeezed and utterly crushed by a pressure of ___(5)___ tons per square inch.

2. (a) do (b) did (c) does (d) have

Ans. (a)

We know that the average depth of the sea is about two and a half miles, but in a few places it is very deep indeed—over six miles. The air presses upon our bodies with a weight of about fifteen pounds to the square inch at ___(1)___ We are used to this air pressure and ___(2)___ not notice it. In the sea this ___(3)___ is doubled at a depth of thirty-five feet, and it ___(4)___ at this rate for greater depths. In the great deeps off the Philippine Islands, a man would be squeezed and utterly crushed by a pressure of ___(5)___ tons per square inch.

3. (a) weight (b) volume (c) pressure (d) temperature

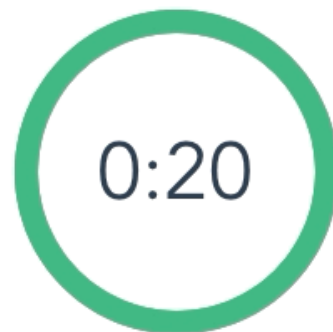

We know that the average depth of the sea is about two and a half miles, but in a few places it is very deep indeed—over six miles. The air presses upon our bodies with a weight of about fifteen pounds to the square inch at __ (1) __ We are used to this air pressure and __ (2) __ not notice it. In the sea this __ (3) __ is doubled at a depth of thirty-five feet, and it __ (4) __ at this rate for greater depths. In the great deeps off the Philippine Islands, a man would be squeezed and utterly crushed by a pressure of __ (5) __ tons per square inch.

3. (a) weight (b) volume (c) pressure (d) temperature

Ans. (c)

We know that the average depth of the sea is about two and a half miles, but in a few places it is very deep indeed—over six miles. The air presses upon our bodies with a weight of about fifteen pounds to the square inch at ___(1)___ We are used to this air pressure and ___(2)___ not notice it. In the sea this ___(3)___ is doubled at a depth of thirty-five feet, and it ___(4)___ at this rate for greater depths. In the great deeps off the Philippine Islands, a man would be squeezed and utterly crushed by a pressure of ___(5)___ tons per square inch.

4. (a) expands (b) decreases (c) increases (d) shrinks

0:20

We know that the average depth of the sea is about two and a half miles, but in a few places it is very deep indeed—over six miles. The air presses upon our bodies with a weight of about fifteen pounds to the square inch at __ (1) __ We are used to this air pressure and __ (2) __ not notice it. In the sea this __ (3) __ is doubled at a depth of thirty-five feet, and it __ (4) __ at this rate for greater depths. In the great deeps off the Philippine Islands, a man would be squeezed and utterly crushed by a pressure of __ (5) __ tons per square inch.

4. (a) expands (b) decreases (c) increases (d) shrinks

Ans. (c)

We know that the average depth of the sea is about two and a half miles, but in a few places it is very deep indeed—over six miles. The air presses upon our bodies with a weight of about fifteen pounds to the square inch at __ (1) __ We are used to this air pressure and __ (2) __ not notice it. In the sea this __ (3) __ is doubled at a depth of thirty-five feet, and it __ (4) __ at this rate for greater depths. In the great deeps off the Philippine Islands, a man would be squeezed and utterly crushed by a pressure of __ (5) __ tons per square inch.

5. (a) severe (b) several (c) sheer (d) many

0:20

We know that the average depth of the sea is about two and a half miles, but in a few places it is very deep indeed—over six miles. The air presses upon our bodies with a weight of about fifteen pounds to the square inch at ___(1)___ We are used to this air pressure and ___(2)___ not notice it. In the sea this ___(3)___ is doubled at a depth of thirty-five feet, and it ___(4)___ at this rate for greater depths. In the great deeps off the Philippine Islands, a man would be squeezed and utterly crushed by a pressure of ___(5)___ tons per square inch.

5. (a) severe (b) several (c) sheer (d) many

Ans. (b)

DIRECTIONS

Read the passage carefully and answer the questions given below.

Some people say that man's desire for war is due to his fight for survival and that war is necessary to preserve his virility. Yet, war now-a-days leaves a legacy of the weakest men and stimulates not the noble but the bestial qualities of mankind.

Adventure of some kind is necessary for man; he will inevitably deteriorate physically and mentally if his life is one of ease and luxury lived in an atmosphere of 'Safety First'. This is the real reason behind our love of sports in the open air. It is no use being a millionaire if one suffers from chronic indigestion; a tramp with good innards is far happier, Nothing that money can buy is worthwhile without good health. There is no better way to perfect health and physical fitness than to walk over or climb hills and mountains.

But mountains give us much more than mere physical fitness ; they exercise the mental faculties as well. Climbing a high and difficult peak is as much a mental exercise as a physical exercise. It calls for sense and judgement for planning and thinking ahead, for anticipating difficulty and danger, for responsibility towards one's companions and best of all, it brings the mountaineer into touch with the beauties of the universe.

Q. According to the passage, nothing that money can buy is worthwhile

(a) without love of sports

(b) without adventure

(c) without good health

(d) without good mental faculties

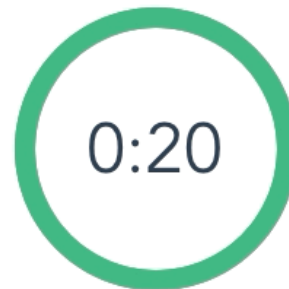

Q. According to the passage, nothing that money can buy is worthwhile

(a) without love of sports

(b) without adventure

(c) without good health

(d) without good mental faculties

Ans. (c)

Q. War now-a-days stimulates

- (a) noble qualities of mankind
- (b) man's virility
- (c) bestial qualities of mankind
- (d) man's fight for survival

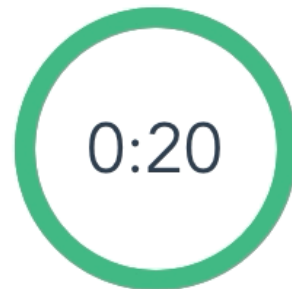

Q. War now-a-days stimulates

- (a) noble qualities of mankind
- (b) man's virility
- (c) bestial qualities of mankind
- (d) man's fight for survival

Ans. (c)

Q. What is the best advantage mountaineering bring to an adventurer?

- (a) Art of planning
- (b) Thinking ahead
- (c) Responsibility towards companions
- (d) Contact with the beauties of the universe

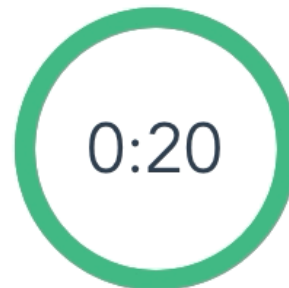

Q. What is the best advantage mountaineering bring to an adventurer?

- (a) Art of planning
- (b) Thinking ahead
- (c) Responsibility towards companions
- (d) Contact with the beauties of the universe

Ans. (d)

Q. According to some, what is the main purpose behind man's desire for war?

(a) love

(b) adventure

(c) ownership and control

(d) fight for survival

0:20

Q. According to some, what is the main purpose behind man's desire for war?

(a) love

(b) adventure

(c) ownership and control

(d) fight for survival

Ans. (d)

Q. Why will man inevitably deteriorate physically and mentally?

- (a) Because of war
- (b) Because of successive mountaineering
- (c) Because of living a life of ease and luxury
- (d) Because of physical and mental health issues

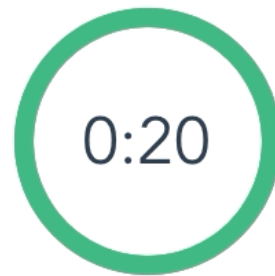

Q. Why will man inevitably deteriorate physically and mentally?

- (a) Because of war
- (b) Because of successive mountaineering
- (c) Because of living a life of ease and luxury
- (d) Because of physical and mental health issues

Ans. (c)

DIRECTIONS

In the following question, out of the four alternatives, select the alternative which is the best substitute of the given phrase.

Q. A person who is greatly respected because of wisdom

- (a) venerable
- (b) verger
- (c) voracious
- (d) vulnerable

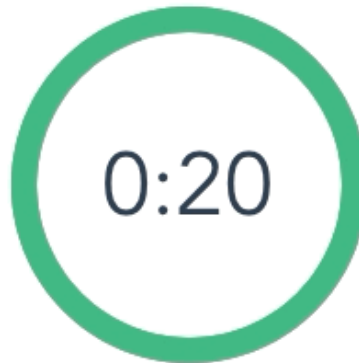

Q. A person who is greatly respected because of wisdom

- (a) venerable
- (b) verger
- (c) voracious
- (d) vulnerable

Ans. (a)

Q. To die without having made a will

(a) Intestate

(b) Insolvent

(c) Inn

(d) Inveterate

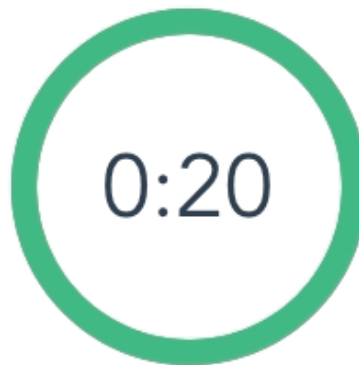

Q. To die without having made a will

(a) Intestate

(b) Insolvent

(c) Inn

(d) Inveterate

Ans. (a)

Q. Science regarding principles of classification

- (a) toxicology
- (b) classicology
- (c) taxidermy
- (d) taxonomy

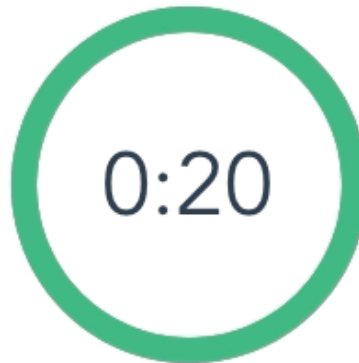

Q. Science regarding principles of classification

- (a) toxicology
- (b) classicology
- (c) taxidermy
- (d) taxonomy

Ans. (d)

Q. One who can tolerate

- (a) Passive
- (b) Stoic
- (c) Tolerant
- (d) Resigned

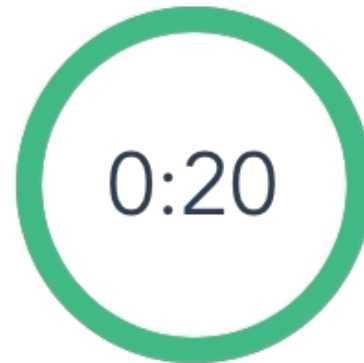

Q. One who can tolerate

(a) Passive

(b) Stoic

(c) Tolerant

(d) Resigned

Ans. (c)

Q. Not easily pleased by anything

- (a) Medieval
- (b) Precarious
- (c) Fastidious
- (d) Maiden

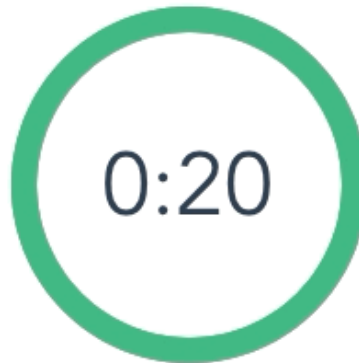

Q. Not easily pleased by anything

- (a) Medieval
- (b) Precarious
- (c) Fastidious
- (d) Maiden

Ans. (c)

Q. Not allowing the passage of light

(a) optique

(b) opulent

(c) oblique

(d) opaque

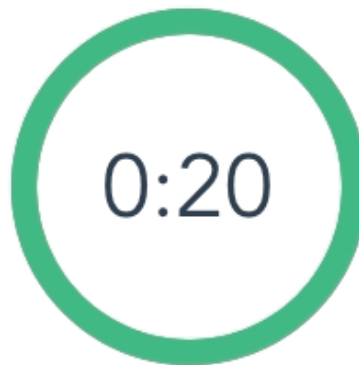

Q. Not allowing the passage of light

(a) optique

(b) opulent

(c) oblique

(d) opaque

Ans. (d)

Q. Animal feeding on another animal

(a) Carnivore

(b) Cannibal

(c) Jade

(d) Capture

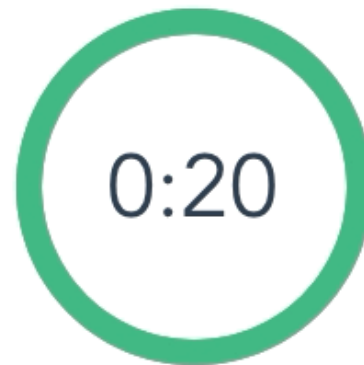

Q. Animal feeding on another animal

(a) Carnivore

(b) Cannibal

(c) Jade

(d) Capture

Ans. (a)

SSB Interview Online Course

★★★★★ 4.9 (26)

Start your SSB Interview preparation today with SSB Crack Exams.

Content 17 (ALL)

Search in bundle

01		COURSE SSB Interview Live Classes	129 LESSONS
02		COURSE Basics of SSB Interview	68 LESSONS
03		COURSE OIR Test - Verbal Reasoning - Part 1	618 LESSONS
04		COURSE OIR Test - Verbal Reasoning - Part 2	401 LESSONS
05		COURSE OIR Test - Non Verbal Reasoning	455 LESSONS
06		COURSE OIR Test - Practice Sets	20 LESSONS

07		COURSE PPDT (Picture Perception & Description Test)	166 LESSONS
08		COURSE Psychological Tests	195 LESSONS
09		COURSE SSB Personal Interview	74 LESSONS
10		COURSE GTO	104 LESSONS
11		COURSE Conference	6 LESSONS
12		COURSE Medical	12 LESSONS
13		COURSE Personality Development and Motivation	151 LESSONS



What's included

17 Courses

30 Days validity [CHANGE](#)

₹ 6,999.00 20% OFF

[BUY BUNDLE](#)





[ENROLL FOR TRIAL](#)

AFCAT Exam Online Coaching 2024

AFCAT 2024: 📺 Live Classes ▶ In-Depth Lectures 📄 Study Notes 📄 Mock Tests 📅 Current Affairs ✂ Defence Current Affairs.

★★★★★ 5.0 (147)

Content 20

-  AFCAT 2 2024 Live Batch - 1
Course • 221 Lessons 1 Trial
-  AFCAT 1 2024 Live Batch - 2
Course • 148 Lessons 2 Trials
-  AFCAT 1 2024 Live Batch - 1
Course • 376 Lessons 1 Trial
-  AFCAT 2 2023 Live Batch
Course • 924 Lessons 3 Trials



AFCAT
Air Force Common Admission Test

- 📺 Live Classes
- ▶ In-Depth Lectures
- 📄 Study Notes
- 📄 Mock Tests
- 📄 Current Affairs
- ✂ Defence Current Affairs.

USE CODE: **"WARRIOR10"**
FOR 10% OFF ON NDA COURSE

🕒 365 Days validity

₹ 5,999 ~~₹ 7,999~~ 25% OFF

[BUY BUNDLE](#) [START A FREE TRIAL](#)

What's included

📄 20 Courses

Other Pricing Plans

Only for AFCAT 2 2024 🔗 Details

180 Days Validity

₹4,999 ~~₹5,999~~ 17% off

[BUY NOW](#)

Choose from our Courses



SSB INTERVIEW
ONLINE COURSE

USE CODE: **WARRIOR10**
FOR 10% OFF ON SSB COURSE

SSB Interview Online Course
2022 - 2023

19 courses ₹9999 **₹6999**



USE CODE: **WARRIOR10**
FOR 10% OFF ON NDA COURSE

NDA Exam Online Course
2023 - 2024

24 courses ₹7999 **₹5999**



USE CODE: **WARRIOR10**
FOR 10% OFF ON OTA COURSE

CDS OTA Exam Online Course
2023 - 2024

23 courses ₹7499 **₹5499**



USE CODE: **WARRIOR10**
FOR 10% OFF ON CDS COURSE

CDS Exam Online Course
2023 - 2024

24 courses ₹7999 **₹5999**



USE CODE: **WARRIOR10**
FOR 10% OFF ON AFCAT COURSE

AFCAT Exam Online Course
2023 - 2024

24 courses ₹7999 **₹5999**



USE CODE: **WARRIOR10**
FOR 10% OFF ON TA COURSE

Territorial Army Exam
Online Course 2022 -2023

26 courses ₹4999 **₹3999**



USE CODE: **WARRIOR10**
FOR 10% OFF ON ACC COURSE

ACC Exam Online Course
2023 - 2024

27 courses ₹5999 **₹4999**



USE CODE: **WARRIOR10**
FOR 10% OFF ON MNS COURSE

MNS Exam Online Course
2023 - 2024

24 courses ₹4999 **₹3999**

[View All](#)

India's Most Popular Portal for Defence Exam Preparation

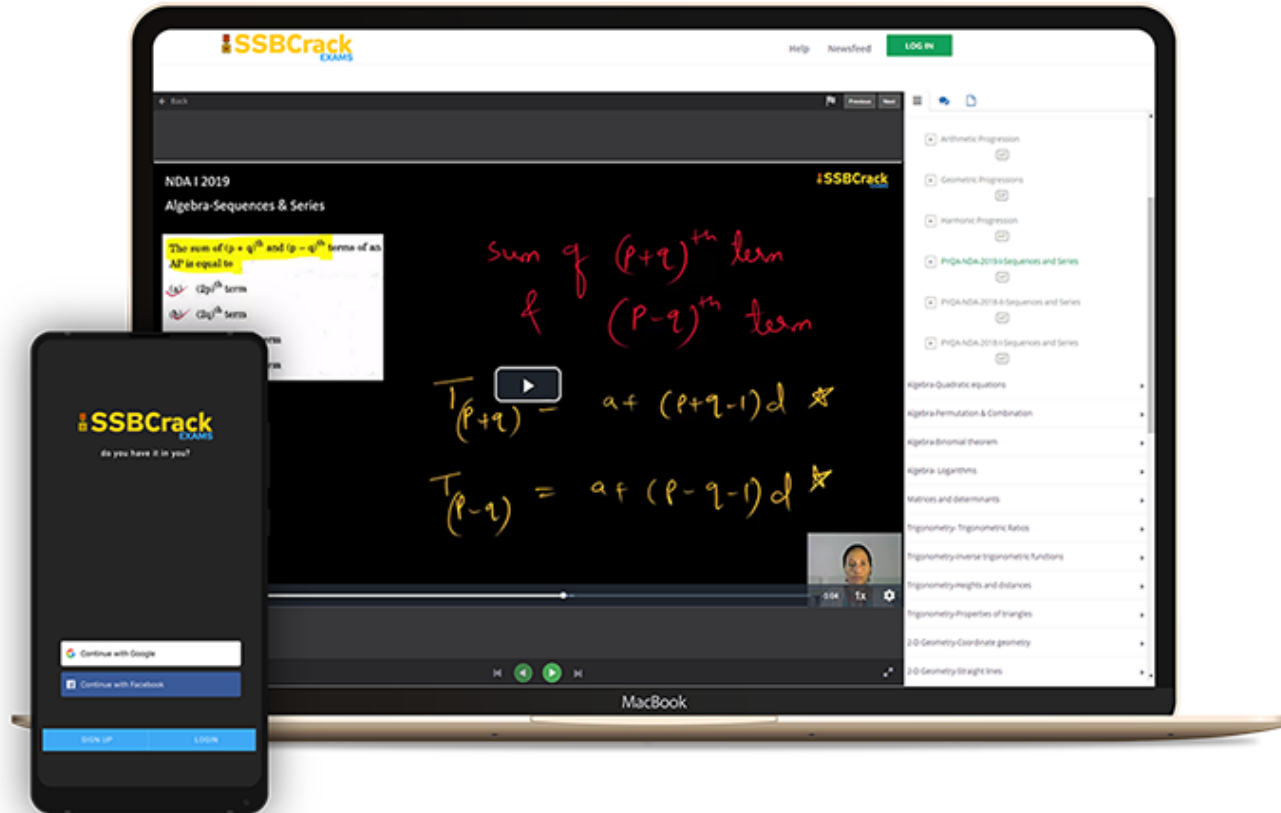
www.ssbcrackexams.com**CODE: WARRIOR10**get an extra **10%** off on all courses



AFCAT 2 2024

MAHA MARATHON #1



COMPLETE REVISION

5TH AUG 2024
1 PM TO 5 PM



LIVE CLASS



AFCAT 2 2024

MAHA MARATHON

05 TO 08 AUG 2024

01 PM TO 02 PM

REASONING - RUBY MA'AM

02 PM TO 03 PM

ENGLISH - ANURADHA MA'AM

03 PM TO 04 PM

STATIC GK - DIVYANSHU SIR

04 PM TO 05 PM

MATHS - NAVJYOTI SIR

 CALL US: 080-69185400

 GET IT ON
Google Play

DOWNLOAD
THE APP NOW







AFCAT Exam Online Coaching 2024

AFCAT 2024: 📺 Live Classes ▶ In-Depth Lectures 📄 Study Notes 📄 Mock Tests 📅 Current Affairs ✂ Defence Current Affairs.

★★★★★ 5.0 (147)

Content 20

-  AFCAT 2 2024 Live Batch - 1
Course • 221 Lessons 1 Trial
-  AFCAT 1 2024 Live Batch - 2
Course • 148 Lessons 2 Trials
-  AFCAT 1 2024 Live Batch - 1
Course • 376 Lessons 1 Trial
-  AFCAT 2 2023 Live Batch
Course • 924 Lessons 3 Trials



AFCAT
Air Force Common Admission Test

- 📺 Live Classes
- ▶ In-Depth Lectures
- 📄 Study Notes
- 📄 Mock Tests
- 📅 Current Affairs
- ✂ Defence Current Affairs.

USE CODE: **"WARRIOR10"**
FOR 10% OFF ON NDA COURSE

🕒 365 Days validity

₹ 5,999 ~~₹ 7,999~~ 25% OFF

[BUY BUNDLE](#) [START A FREE TRIAL](#)

What's included

📄 20 Courses

Other Pricing Plans

Only for AFCAT 2 2024 🔗 Details

180 Days Validity

₹4,999 ~~₹5,999~~ 17% off

[BUY NOW](#)

Choose from our Courses



SSB INTERVIEW
ONLINE COURSE

USE CODE: **WARRIOR10**
FOR 10% OFF ON SSB COURSE

SSB Interview Online Course
2022 - 2023

19 courses ₹9999 **₹6999**



USE CODE: **WARRIOR10**
FOR 10% OFF ON NDA COURSE

NDA Exam Online Course
2023 - 2024

24 courses ₹7999 **₹5999**



USE CODE: **WARRIOR10**
FOR 10% OFF ON OTA COURSE

CDS OTA Exam Online Course
2023 - 2024

23 courses ₹7499 **₹5499**



USE CODE: **WARRIOR10**
FOR 10% OFF ON CDS COURSE

CDS Exam Online Course
2023 - 2024

24 courses ₹7999 **₹5999**



USE CODE: **WARRIOR10**
FOR 10% OFF ON AFCAT COURSE

AFCAT Exam Online Course
2023 - 2024

24 courses ₹7999 **₹5999**



USE CODE: **WARRIOR10**
FOR 10% OFF ON TA COURSE

Territorial Army Exam
Online Course 2022 -2023

26 courses ₹4999 **₹3999**



USE CODE: **WARRIOR10**
FOR 10% OFF ON ACC COURSE

ACC Exam Online Course
2023 - 2024

27 courses ₹5999 **₹4999**



USE CODE: **WARRIOR10**
FOR 10% OFF ON MNS COURSE

MNS Exam Online Course
2023 - 2024

24 courses ₹4999 **₹3999**

[View All](#)

India's Most Popular Portal for Defence Exam Preparation

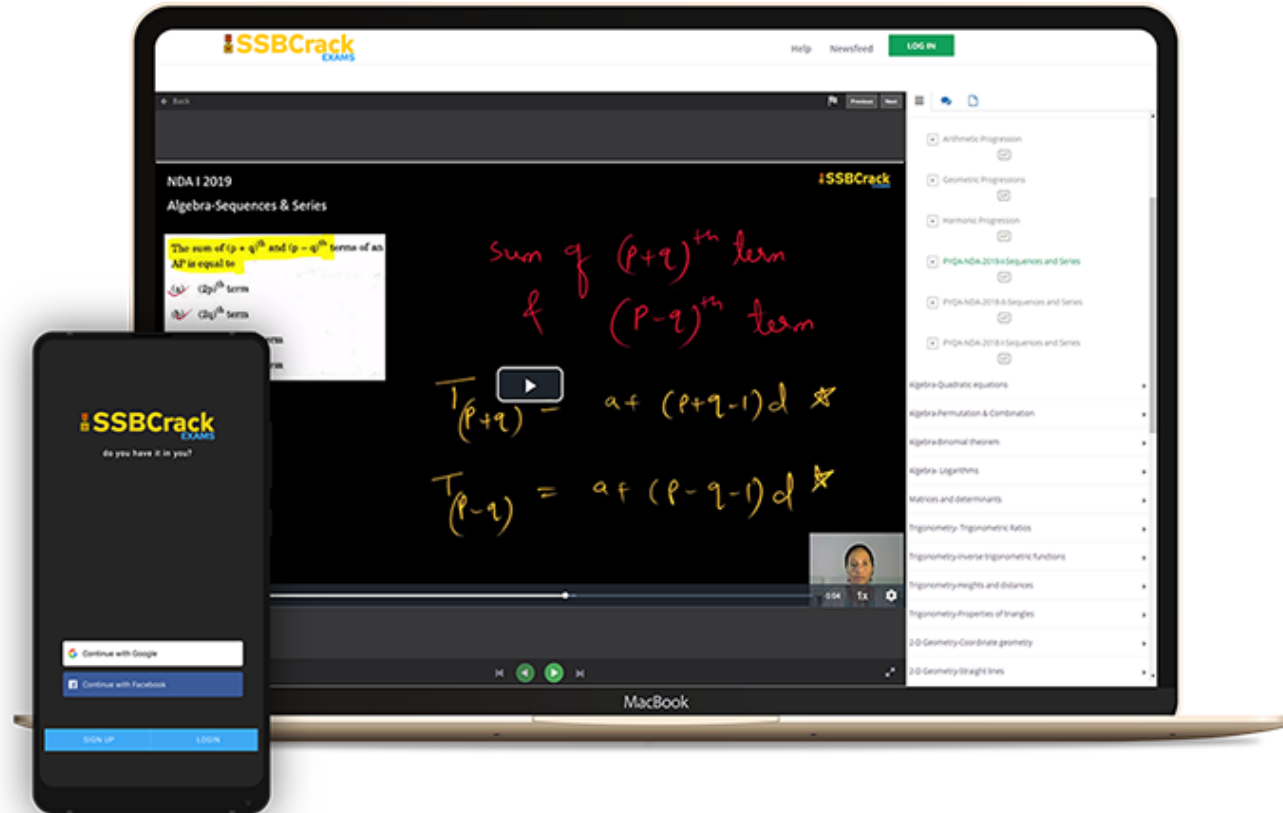
www.ssbcrackexams.com**CODE: WARRIOR10**

get an extra 10% off on all courses





REVIEW QUESTIONS

Q. Which country is hosted Exercise Pitch Black 2024??

- A. Australia
- B. India
- C. United States
- D. United Kingdom

Q. Which country is hosted Exercise Pitch Black 2024??

- A. Australia**
- B. India
- C. United States
- D. United Kingdom

Q. Which film won the award for Best Feature Film?

- A. Rocketry
- B. Sardar Udham
- C. RRR
- D. The Kashmir Files

Q. Which film won the award for Best Feature Film?

A. Rocketry

B. Sardar Udham

C. RRR

D. The Kashmir Files

Q. Which film won the award for Best Hindi Film?

- A. Sardar Udham
- B. Rocketry
- C. RRR
- D. The Kashmir Files

Q. Which film won the award for Best Hindi Film?

A. Sardar Udham

B. Rocketry

C. RRR

D. The Kashmir Files

Q. Which country will host the 2025 Men's Asia Cup cricket tournament?

- A. Pakistan
- B. Sri Lanka
- C. India
- D. Bangladesh

Q. Which country will host the 2025 Men's Asia Cup cricket tournament?

A. Pakistan

B. Sri Lanka

C. India

D. Bangladesh

Q. When is the World Day Against Trafficking in Persons observed annually?

- A. June 15
- B. July 30
- C. August 1
- D. September 5

Q. When is the World Day Against Trafficking in Persons observed annually?

- A. June 15
- B. July 30**
- C. August 1
- D. September 5

The World Day Against Trafficking in Persons is observed annually on July 30th. This day is crucial for raising global awareness about human trafficking and reinforcing the commitment to combating this grave violation of human rights.

Q. Who among the following has been awarded the Eklavya Award for the year 2023?

- A. Pankaj Chowdhary
- B. Swasti Singh
- C. Mahima Sharma
- D. Debasis Sahoo

Q. Who among the following has been awarded the Eklavya Award for the year 2023?

- A. Pankaj Chowdhary
- B. Swasti Singh
- C. Mahima Sharma
- D. Debasis Sahoo**

Q. Which country recently sent its first coal consignment to India via the International North-South Transport Corridor (INSTC)?

- A. Iran
- B. Russia
- C. Armenia
- D. Azerbaijan

Q. Which country recently sent its first coal consignment to India via the International North-South Transport Corridor (INSTC)?

A. Iran

B. Russia

C. Armenia

D. Azerbaijan

Russia has sent two trains carrying coal to India through the International North-South Transport Corridor (INSTC) for the first time. The consignment will travel over 7,200 km from St. Petersburg, Russia to Mumbai port via Bandar Abbas port in Iran. It integrates shipping, rail, and road networks to facilitate cargo movement between India, Iran, Azerbaijan, Russia, Central Asia, and Europe.

Q. Who has been appointed as the new director of the Indian Agricultural Research Institute (IARI)?

- A. Ashok K Singh
- B. S K Singh
- C. T R Sharma
- D. Ramesh Kumar

Q. Who has been appointed as the new director of the Indian Agricultural Research Institute (IARI)?

- A. Ashok K Singh
- B. S K Singh
- C. T R Sharma**
- D. Ramesh Kumar

The Indian Agricultural Research Institute (IARI) appointed T R Sharma as its new director, replacing Ashok K Singh. Currently holding the position of Deputy Director General (Crop Science) at ICAR, Sharma brings substantial experience and expertise in agricultural sciences to his new role.

Q. Who has been given the PETA India 2023 'Person of the Year' award?

- A. Nidhi Srivastava
- B. Sonakshi Sinha
- C. Pankaj Gill
- D. Dia Mirza

Q. Who has been given the PETA India 2023 'Person of the Year' award?

A. Nidhi Srivastava

B. Sonakshi Sinha

C. Pankaj Gill

D. Dia Mirza

Q. On which date is GST Day observed annually in India?

- A. June 30
- B. July 1
- C. August 15
- D. September 1

Q. On which date is GST Day observed annually in India?

- A. June 30
- B. July 1**
- C. August 15
- D. September 1

GST Day is observed on July 1 each year to commemorate the implementation of the Goods and Services Tax (GST) system in India, which was enacted through the Constitution (101st Amendment) Act in 2016.

Q. Where is Air India establishing South Asia's largest flight training school?

- A. Ahmedabad
- B. Amravati
- C. Chennai
- D. Tiruchirappalli

Q. Where is Air India establishing South Asia's largest flight training school?

- A. Ahmedabad
- B. Amravati**
- C. Chennai
- D. Tiruchirappalli

Air India is setting up South Asia's largest flight training school in Amravati, Maharashtra, with an investment exceeding ₹200 crore. This initiative, in partnership with Maharashtra Airport Development Company (MADC), aims to train 180 commercial pilots annually

Q. Who won the 2024 Leon Masters Chess Championship?

- A. Arjun Erigaisi
- B. Veselin Topalov
- C. Jaime Santos Latasa
- D. Viswanathan Anand

Q. Who won the 2024 Leon Masters Chess Championship?

- A. Arjun Erigaisi
- B. Veselin Topalov
- C. Jaime Santos Latasa
- D. Viswanathan Anand**

Viswanathan Anand, the former world chess champion from India, clinched the 2024 Leon Masters Chess Championship for an unprecedented 10th time by defeating Jaime Santos Latasa in the final with a score of 3-1.

Q. Which sport did Bhupinder Singh Rawat play professionally?

- A. Cricket
- B. Hockey
- C. Football
- D. Tennis

Q. Which sport did Bhupinder Singh Rawat play professionally?

- A. Cricket
- B. Hockey
- C. Football**
- D. Tennis



Bhupinder Singh Rawat, known for his speed and agility as a winger, played football professionally until his passing on June 29, 2024, after a brief illness.

Q. Which country secured both the men's and women's titles at the 2024 BWF Thomas & Uber Cup Finals?

- A. Indonesia
- B. India
- C. Japan
- D. China

Q. Which country secured both the men's and women's titles at the 2024 BWF Thomas & Uber Cup Finals?

- A. Indonesia
- B. India
- C. Japan
- D. China**

China reclaimed its position as the top badminton nation by winning both the men's and women's titles at the 2024 BWF Thomas & Uber Cup Finals held in Chengdu.

Q. Who has been appointed as the National Ambassador for UNICEF India?

- A. Gauranshi Sharma
- B. Kartik Verma
- C. Nahid Afrin
- D. Kareena Kapoor Khan

Q. Who has been appointed as the National Ambassador for UNICEF India?

A. Gauranshi Sharma

B. Kartik Verma

C. Nahid Afrin

D. Kareena Kapoor Khan

Kareena Kapoor Khan has been appointed as the National Ambassador for UNICEF India, recognizing her longstanding association and dedication to children's rights and welfare.

Q. Which football club clinched the La Liga 2023-24 season title?

- A. Barcelona
- B. Girona
- C. Real Madrid
- D. Cadiz

Q. Which football club clinched the La Liga 2023-24 season title?

- A. Barcelona
- B. Girona
- C. Real Madrid**
- D. Cadiz

Real Madrid, the Spanish football giants, secured their 36th La Liga title in the 2023-24 season. They achieved this milestone after defeating Cadiz 3-0, while their closest rivals Barcelona faced a 4-2 loss against Girona.

Q. When is World Asthma Day 2024 observed?

- A. May 7
- B. May 1
- C. May 10
- D. May 15

Q. When is World Asthma Day 2024 observed?

A. May 7

B. May 1

C. May 10

D. May 15

World Asthma Day 2024 is observed on May 7, 2024. This day, organized by the Global Initiative for Asthma (GINA) in collaboration with the World Health Organization, aims to raise awareness about asthma, a chronic lung disease affecting millions globally. The theme for this year is "**Asthma Education Empowers**".

Q. Which film has won the Best Film Award at the 68th National Film Awards?

- A. soorarai potru
- B. manadu
- C. Annatte
- D. irul

Q. Which film has won the Best Film Award at the 68th National Film Awards?

A. soararai potru

B. manadu

C. Annatte

D. irul



- The jury for the 68th National Film Awards has announced the winners for the year 2020 at the National Media Center in New Delhi.
- The National Award for Most Film Friendly State went to Madhya Pradesh, and Uttarakhand and Uttar Pradesh received special mentions.

Q. Which team secured its record-extending 15th UEFA Champions League title'?

- A. Barcelona
- B. Real Madrid
- C. Bayern Munich
- D. Liverpool

Q. Which team secured its record-extending 15th UEFA Champions League title'?

- A. Barcelona
- B. Real Madrid**
- C. Bayern Munich
- D. Liverpool

Real Madrid secured their historic 15th UEFA Champions League title with a 2-0 victory over Borussia Dortmund at Wembley Stadium. This victory further solidified Real Madrid's unparalleled dominance in European football.

Q. Tansen Samman is conferred to the field

- A. Journalism
- B. Science
- C. Literature
- D. Music

Q. Tansen Samman is conferred to the field

A. Journalism

B. Science

C. Literature

D. Music

Q. In which category has Nisha Pahuja's film 'To Kill a Tiger' been nominated for the Oscars 2024?

- A. Best Feature Film
- B. Best International Film
- C. Best Short Film
- D. Best Documentary

Q. In which category has Nisha Pahuja's film 'To Kill a Tiger' been nominated for the Oscars 2024?

- A. Best Feature Film
- B. Best International Film
- C. Best Short Film
- D. Best Documentary**

Nisha Pahuja's 'To Kill a Tiger' has earned an Oscars 2024 nomination in the Best Documentary category. The documentary centres around an Indian farmer's legal battle for justice after his daughter's brutal sexual assault, emphasizing the film's societal impact.

Q. Who is set to be posthumously awarded the 'Bharat Ratna'?

- A. Kalyan Singh
- B. Mulayam Singh Yadav
- C. Hemananda Biswal
- D. Karpoori Thakur

Q. Who is set to be posthumously awarded the 'Bharat Ratna'?

- A. Kalyan Singh
- B. Mulayam Singh Yadav
- C. Hemananda Biswal
- D. Karpoori Thakur**

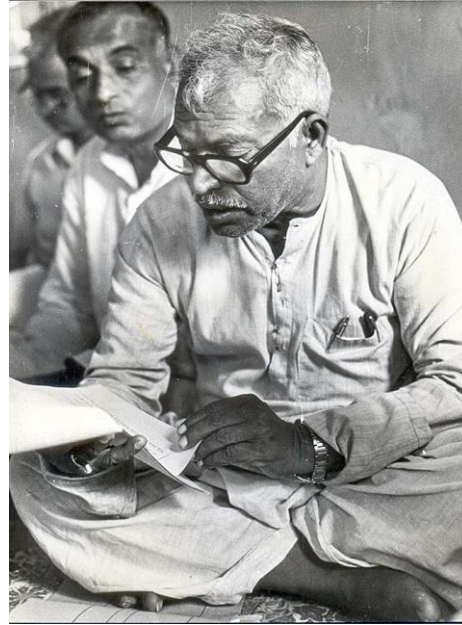

Karpoori Thakur, a prominent Gandhian socialist leader and former Bihar chief minister, is set to be posthumously awarded the 'Bharat Ratna' for his outstanding service. He served as the chief minister of Bihar during two terms, from December 1970 to June 1971 and from December 1977 to April 1979.

Q. Which company was recognized for its outstanding cargo services at the Wings India Awards?

- A. Blue Dart Aviation
- B. Spice Xpress
- C. Skyways Air Services
- D. Delivery

Q. Which company was recognized for its outstanding cargo services at the Wings India Awards?

A. Blue Dart Aviation

B. Spice Xpress

C. Skyways Air Services

D. Delivery

Skyways Air Services has been lauded for its exceptional cargo services, earning the prestigious Best Cargo Services Award at the Wings India Awards. This achievement highlights their dedication to providing high-quality air cargo services within the aviation industry.

Q. Which organization was honoured for Encouragement to Sports via Corporate Social Responsibility in the 'Rashtriya Khel Protsahan Puruskar'?

- A. Tata Consultancy Services
- B. Reliance Industries
- C. Odisha Mining Corporate Limited
- D. Infosys

Q. Which organization was honoured for Encouragement to Sports via Corporate Social Responsibility in the 'Rashtriya Khel Protsahan Puruskar'?

- A. Tata Consultancy Services
- B. Reliance Industries
- C. Odisha Mining Corporate Limited**
- D. Infosys

Q. Who has been honoured with the 2023 Kuvempu Rashtriya Puraskar for his significant contributions to Indian languages?

- A. Jhumpa Lahiri
- B. Shirshendu Mukhopadhyay
- C. Arundhati Roy
- D. Chetan Bhagat

Q. Who has been honoured with the 2023 Kuvempu Rashtriya Puraskar for his significant contributions to Indian languages?

A. Jhumpa Lahiri

B. Shirshendu Mukhopadhyay

C. Arundhati Roy

D. Chetan Bhagat

Shirshendu Mukhopadhyay, a celebrated Bengali writer, has been honoured with the 2023 Kuvempu Rashtriya Puraskar for his remarkable contributions across various genres, including travelogues and children's fiction. The prestigious award includes a cash prize of Rs 5 lakh, a silver medal, and a citation, highlighting his significant impact on Indian literature.

Q. Which athlete received the Arjuna Award for Outstanding Performance in Sports and Games 2023 for their achievements in Wushu?

- A. Deepika Kumari
- B. Naorem Roshibina Devi
- C. Dutee Chand
- D. Savita Punia

Q. Which athlete received the Arjuna Award for Outstanding Performance in Sports and Games 2023 for their achievements in Wushu?

A. Deepika Kumari

B. Naorem Roshibina Devi

C. Dutee Chand

D. Savita Punia

The Arjuna Award for Outstanding Performance in Sports and Games 2023 was bestowed upon Naorem Roshibina Devi in recognition of her exceptional performance and contributions to the sport of Wushu over the previous four years. This award highlights her remarkable athletic abilities, sportsmanship, discipline, and leadership qualities within her discipline.

Q. Who were the recipients of the Indira Gandhi Prize for Peace 2023?

- A. Daniel Barenboim and Ali Abu Award
- B. Angela Merkel and Kofi Annan
- C. Wolfgang Amadeus Mozart and Aung San Suu Kyi
- D. Pratham NGO and Sir David Attenborough

Q. Who were the recipients of the Indira Gandhi Prize for Peace 2023?

- A. Daniel Barenboim and Ali Abu Award**
- B. Angela Merkel and Kofi Annan
- C. Wolfgang Amadeus Mozart and Aung San Suu Kyi
- D. Pratham NGO and Sir David Attenborough

Daniel Barenboim, a classical pianist, and Ali Abu Award, a Palestinian peace activist, were jointly awarded the Indira Gandhi Prize for Peace 2023 for their exceptional contributions to fostering peace and non-violent resolution in the Israel-Palestine conflict.

Q. Consider the statement regarding HS Prannoy.

1. He won silver at the BWF World Championship 2023.

2. He lost to Viktor Axelsen in the finals.

Select the correct answer by using the code mentioned below.

A. Only 1

B. Both 1 and 2

C. Neither 1 nor 2

D. Only 2

Q. Consider the statement regarding HS Prannoy.

1. He won silver at the BWF World Championship 2023.

2. He lost to Viktor Axelsen in the finals.

Select the correct answer by using the code mentioned below.

A. Only 1

B. Both 1 and 2

C. Neither 1 nor 2

D. Only 2

- **H. S. Prannoy** is an **Indian badminton player**.
- He **won bronze** at the **BWF World Championship 2023**.
- He won the medal for India by **beating World Number 2 Viktor Axelsen** in the quarterfinals.
- He came to prominence after winning the **silver medal in Boys' singles at the 2010 Summer Youth Olympics**.

Q. The 2023 Nobel Prize in Chemistry has been awarded to Moungi G. Bawendi, Louis E. Brus and Alexei I. Ekimov for which of the following discoveries?

- A. For the development of click chemistry and bio-orthogonal chemistry
- B. For Discoveries made in Scattering effect
- C. For the discovery and synthesis of quantum dots
- D. More than one of the above

Q. The 2023 Nobel Prize in Chemistry has been awarded to Moungi G. Bawendi, Louis E. Brus and Alexei I. Ekimov for which of the following discoveries?

- A. For the development of click chemistry and bio-orthogonal chemistry
- B. For Discoveries made in Scattering effect
- C. For the discovery and synthesis of quantum dots**
- D. More than one of the above

Q. Where did the 21st Shangri-La Dialogue take place?

- A. Malaysia
- B. Thailand
- C. Singapore
- D. China

Q. Where did the 21st Shangri-La Dialogue take place?

- A. Malaysia
- B. Thailand
- C. Singapore**
- D. China

The 21st Shangri-La Dialogue, a significant defence summit in the Asia-Pacific region, concluded in Singapore. This annual event, organized by the International Institute for Strategic Studies (IISS), gathers delegates from around the world to discuss pressing security challenges and explore new approaches.

Q. According to the 2024 Global 500 IT Services Ranking by Brand Finance, which company is rated as the second most valuable IT services brand in the world?

- A. Tata Consultancy Services
- B. IBM
- C. Accenture
- D. Infosys

Q. According to the 2024 Global 500 IT Services Ranking by Brand Finance, which company is rated as the second most valuable IT services brand in the world?

A. Tata Consultancy Services

B. IBM

C. Accenture

D. Infosys

Tata Consultancy Services (TCS) achieved a significant milestone by being rated the second most valuable IT services brand globally in the 2024 Global 500 IT Services Ranking by Brand Finance. With a brand value surge to \$19.2 billion, TCS demonstrates industry leadership, innovation commitment, and global recognition. Accenture holds the top position as the world's most valuable IT services brand, with a brand value of USD 40.5 billion.

Q. Who has been appointed as India's ambassador to the World Trade Organisation (WTO) in Geneva?

- A. Rajesh Kumar Singh
- B. Senthil Pandian C
- C. Anjali Sharma
- D. Prakash Verma

Q. Who has been appointed as India's ambassador to the World Trade Organisation (WTO) in Geneva?

- A. Rajesh Kumar Singh
- B. Senthil Pandian C**
- C. Anjali Sharma
- D. Prakash Verma

Senthil Pandian C, a 2002 IAS officer from the Uttar Pradesh cadre, has been appointed as India's ambassador to the World Trade Organisation (WTO) in Geneva, succeeding Brajendra Navnit.

Q. Who has officially assumed the role of Secretary General of BIMSTEC, succeeding Tenzin Lekphell?

- A. M Shahidul Islam
- B. Indra Mani Pandey
- C. Sumith Nakandala
- D. Kavita Krishnamurthy

Q. Who has officially assumed the role of Secretary General of BIMSTEC, succeeding Tenzin Lekphell?

- A. M Shahidul Islam
- B. Indra Mani Pandey**
- C. Sumith Nakandala
- D. Kavita Krishnamurthy

Ambassador Indra Mani Pandey, a seasoned Indian diplomat, has taken on the role of Secretary General of BIMSTEC, succeeding Tenzin Lekphell from Bhutan.

Q. Who has been appointed as the CEO of the Indian Olympic Association?

- A. Suresh Kalmadi
- B. Raghuram Iyer
- C. Karthik Gupta
- D. Bhalindra Singh

Q. Who has been appointed as the CEO of the Indian Olympic Association?

A. Suresh Kalmadi

B. Raghuram Iyer

C. Karthik Gupta

D. Bhalindra Singh

The Indian Olympic Association has appointed Raghuram Iyer as its new CEO, a seasoned professional chosen through a meticulous selection process.

Q. Which airport's Terminal 2 recently received recognition as one of the 'World's most beautiful airports' at UNESCO's 2023 Prix Versailles?

- A. Kempegowda International Airport
- B. Indira Gandhi International Airport
- C. Chhatrapati Shivaji Maharaj International Airport
- D. Rajiv Gandhi International Airport

Q. Which airport's Terminal 2 recently received recognition as one of the 'World's most beautiful airports' at UNESCO's 2023 Prix Versailles?

- A. Kempegowda International Airport**
- B. Indira Gandhi International Airport
- C. Chhatrapati Shivaji Maharaj International Airport
- D. Rajiv Gandhi International Airport

Bengaluru's Kempegowda International Airport's Terminal 2 was honoured with two prestigious recognitions at UNESCO's 2023 Prix Versailles, being named one of the 'World's Most Beautiful Airports' and securing the coveted 'World Special Prize for an interior 2023.

Q. Who is known as the 'Queen of Millet' and was invited to the G20 Summit in commemoration of the 'International Year of Millets'?

- A. Kundra Bati Mandia
- B. Jasra
- C. Raimati Ghiuria
- D. Juana

Q. Who is known as the 'Queen of Millet' and was invited to the G20 Summit in commemoration of the 'International Year of Millets'?

A. Kundra Bati Mandia

B. Jasra

C. Raimati Ghiuria

D. Juana

Raimati Ghiuria, a tribal farmer from Odisha's Koraput district, earned the title 'Queen of Millet' and was invited to the G20 Summit in recognition of her efforts in preserving 30 varieties of millets and training women in their cultivation.

Q. Which space agency was honoured with the Leif Erikson Lunar Prize for its unwavering commitment to lunar exploration?

A. ISRO

B. NASA

C. ESA

D. CNSA

The Leif Erikson Lunar Prize, named after the legendary Norse explorer Leif Erikson, is an annual accolade presented by the Exploration Museum in Husavik, Iceland. ISRO, the Indian Space Research Organisation, received the Leif Erikson Lunar Prize as recognition for its significant contributions and commitment to lunar exploration, highlighting the achievements of the Chandrayaan-3 mission.

Q. Who has received the Nobel Peace Prize for 2023?

A. Ales Bilyatsky

B. Narges Mohammadi

C. Center for Civil Liberties

D. All of the above

Q. Which country's film won the Golden Royal Bengal Tiger Award for Best Film at the 29th Kolkata International Film Festival?

- A. Israel
- B. Finland
- C. Italy
- D. Japan

Q. Which country's film won the Golden Royal Bengal Tiger Award for Best Film at the 29th Kolkata International Film Festival?

A. Israel

B. Finland

C. Italy

D. Japan

'Children of Nobody,' an Israeli film, was honoured with the Golden Royal Bengal Tiger Award for Best Film at the 29th Kolkata International Film Festival. The film, inspired by a true story, focuses on the overlooked individuals at the fringes of society.

Q. How many books were declared joint winners of the Gaja Capital Business Book Prize 2023?

- A. 5
- B. 3
- C. 2
- D. 4

Q. How many books were declared joint winners of the Gaja Capital Business Book Prize 2023?

- A. 5
- B. 3
- C. 2**
- D. 4

The Gaja Capital Business Book Prize 2023 honoured two outstanding narratives, "Against All Odds: The IT Story of India" and "Winning Middle India: The Story of India's New-Age Entrepreneurs," as joint winners, providing insights into India's dynamic business landscape.

Q. In which country did three Indian Armed Forces officers receive the 'Golden Owl' award for their outstanding performance?

- A. Sri Lanka
- B. Bangladesh
- C. Nepal
- D. Bhutan

Q. In which country did three Indian Armed Forces officers receive the 'Golden Owl' award for their outstanding performance?

A. Sri Lanka

B. Bangladesh

C. Nepal

D. Bhutan

Three Indian Armed Forces officers have been recognized for their exceptional performance at the Defence Services Command and Staff College (DSCSC) in Sri Lanka, where they received the prestigious 'Golden Owl' award.

Q. Who has been named the 2023 ITF World Champions by the International Tennis Federation?

- A. Federer and Osaka
- B. Nadal and Halep
- C. Djokovic and Sabalenka
- D. Murray and Pliskova

Q. Who has been named the 2023 ITF World Champions by the International Tennis Federation?

- A. Federer and Osaka
- B. Nadal and Halep
- C. Djokovic and Sabalenka**
- D. Murray and Pliskova

Novak Djokovic and Aryna Sabalenka earned the title of 2023 ITF World Champions for their exceptional performances, with Djokovic achieving his eighth ITF World Champion award.

Q. The first black American to win the Nobel Prize for literature is

- A. Aurthe Ashe
- B. Martin Luther King
- C. Toni Morrison
- D. Nelson Mandela

Q. The first black American to win the Nobel Prize for literature is

- A. Aurthe Ashe
- B. Martin Luther King
- C. Toni Morrison**
- D. Nelson Mandela

Q. Mother Teresa won the Nobel Prize for Peace in

A. 1992

B. 1979

C. 1988

D. 1954

Q. Mother Teresa won the Nobel Prize for Peace in

A. 1992

B. 1979

C. 1988

D. 1954

Q. Danish Siddiqui posthumously got which city's Press Club's RedInk Award?

- A. Chennai
- B. Mumbai
- C. Delhi
- D. Pune

Q. Danish Siddiqui posthumously got which city's Press Club's RedInk Award?

A. Chennai

B. Mumbai

C. Delhi

D. Pune

Q. Who has been honoured with the Hindi Sahitya Bharati Award?

- A. Kabir Singh
- B. Tapan Bandopadhyay
- C. Bratya Basu
- D. Krishna Prakash

Q. Who has been honoured with the Hindi Sahitya Bharati Award?

- A. Kabir Singh
- B. Tapan Bandopadhyay
- C. Bratya Basu

D. Krishna Prakash

Krishna Prakash, renowned for leading Mumbai Police's special counterterrorism team, Force One, has been honoured with the prestigious Hindi Sahitya Bharati Award. This award recognizes his contributions and achievements, including his leadership role in counterterrorism efforts and his initiatives to promote cultural and literary endeavours.

Q. When is India aiming to land an astronaut on the moon, as revealed by ISRO

Chief S Somanath?

- A. 2030
- B. 2035
- C. 2040
- D. 2045

Q. When is India aiming to land an astronaut on the moon, as revealed by ISRO

Chief S Somanath?

A. 2030

B. 2035

C. 2040

D. 2045

ISRO Chief S Somanath announced that India aims to land an astronaut on the moon by 2040, as part of the upcoming Chandrayaan-4 mission, highlighting India's ambitious lunar exploration goals and the progress in ISRO's space projects.

Q. When is the International Day of Human Space Flight celebrated?

- A. April 10
- B. April 12
- C. April 15
- D. April 20

Q. When is the International Day of Human Space Flight celebrated?

- A. April 10
- B. April 12**
- C. April 15
- D. April 20

The International Day of Human Space Flight is celebrated on April 12 each year, marking the historic achievement of Yuri Gagarin's orbit around Earth aboard the Vostok 1 spacecraft, which initiated the space era for humanity and contributed significantly to space exploration.

Q. With which country does India conduct the joint military exercise DUSTLIK?

- A. Oman
- B. Uzbekistan
- C. Kazakhstan
- D. Turkmenistan

Q. With which country does India conduct the joint military exercise DUSTLIK?

- A. Oman
- B. Uzbekistan**
- C. Kazakhstan
- D. Turkmenistan

The fifth edition of Exercise DUSTLIK takes place in Uzbekistan, marking a significant step in strengthening bilateral relations and enhancing military cooperation between India and Uzbekistan through joint training sessions focusing on sub conventional operations.

Q. Who has been honored with the 'Indian Film Personality of the Year' award at the 53rd International Film Festival?

- A. Rajinikanth
- B. Amitabh Bachchan
- C. Chiranjeevi
- D. Salman Khan

Q. Who has been honored with the 'Indian Film Personality of the Year' award at the 53rd International Film Festival?

- A. Rajinikanth
- B. Amitabh Bachchan
- C. Chiranjeevi**
- D. Salman Khan



- Chiranjeevi has been awarded the Indian Film Personality of the Year 2022 at the 53rd International Film Festival.
 - Chiranjeevi has worked in Hindi, Tamil and Kannada films.
 - He has also received 10 Filmfare Awards and four Nandi Awards.
-

Q. Who has recently won the 'World Green City' award?

- A. Paris
- B. Hyderabad
- C. London
- D. Oslo

Q. Who has recently won the 'World Green City' award?

A. Paris

B. Hyderabad

C. London

D. Oslo

- Hyderabad has won the award at the International Association of Horticulture Producers (AIPH) 2022 World Green City Awards held on 14 October in Jeju, South Korea.
- Apart from this, Hyderabad has also won the award in the category of 'Living Green for Economic Recovery and Inclusive Growth' given to it for the state's 'Telangana Haritaharam' programme.

Q. Who among the following has received the Nobel Prize in Economics?

- A. Ben Brennanki
- B. Douglas Diamond
- C. Philip H. Dewig
- D. All of the above

Q. Who among the following has received the Nobel Prize in Economics?

- A. Ben Brennanki
- B. Douglas Diamond
- C. Philip H. Dewig
- D. All of the above**

- The Nobel Prize in Economics for the year 2022 has been jointly given to Ben S. Bernanke, former chairman of the US Federal Reserve, and two US economists Douglas W. Diamond and Philip H. Diebwig.
- This award has been given to him for his research in the field of bank and financial crisis.

Q. Who has received the Nobel Peace Prize for 2022?

- A. Ales Bilyatsky
- B. Memorial
- C. Center for Civil Liberties
- D. All of the above

Q. Who has received the Nobel Peace Prize for 2022?

- A. Ales Bilyatsky
- B. Memorial
- C. Center for Civil Liberties

D. All of the above

- The Nobel Peace Prize for 2022 has been announced to be awarded to Belarusian human rights advocate Ales Bilyatsky, Russian human rights organization 'Memorial' and Ukraine's human rights organization 'Center for Civil Liberties'.
- The names were announced in Oslo by Berit Reis Andersen, chairman of the Norwegian Nobel Committee.

Q. Who has received the 2022 Nobel Prize in Literature?

A. Allen's Aspect

B. Carl Barry Sharpless

C. Anton Zeilinger

D. Annie Arnox

- The Nobel Prize in Literature for the year 2022 has been awarded to 82-year-old French writer Anne Arnox.
- Annie has written several articles on bold clinical acuity through her writing.
- The Academy of Sweden has awarded this French writer th Nobel Prize for boldly expressing her personal experiences with the systems.

Q. Who among the following has received the Nobel Prize in Chemistry?

- A. Caroline Bertozzi
- B. Morton Meldl
- C. Barry Sharpless
- D. All of the above

Q. Who among the following has received the Nobel Prize in Chemistry?

A. Caroline Bertozzi

B. Morton Meldl

C. Barry Sharpless

D. All of the above

- The Nobel Prize in Chemistry in the year 2022 has been jointly awarded to Carolyn Bertozzi, Morton Medel and Barry Sharpless for their effective research into the treatment of cancer.
- This award has been given for the work done on Snipping of Molecules Together.
- Caroline Bertozzi and Barry Sharpless of the United States, and Morten Meldl, a Danish scientist, were noted for their work on click chemistry and bioorthogonal reactions.

Q. The term “Stopper, Defender” are used in:

- A. Volleyball
- B. Tennis
- C. Snooker
- D. Football

Q. The term “Stopper, Defender” are used in:

- A. Volleyball
- B. Tennis
- C. Snooker
- D. Football**



Q. Freestyle is the term used in _____.

- A. polo
- B. golf
- C. wrestling
- D. baseball

Q. Freestyle is the term used in _____.

- A. polo
- B. golf
- C. **wrestling**
- D. baseball



Q. The term 'Jerk' is associated with which sport?

- A. Weightlifting
- B. Swimming
- C. Cricket
- D. Tennis

Q. The term 'Jerk' is associated with which sport?

A. Weightlifting

B. Swimming

C. Cricket

D. Tennis



Q. The term 'double fault' is associated with which sport?

- A. Basketball
- B. Football
- C. Tennis
- D. Golf

Q. The term 'double fault' is associated with which sport?

- A. Basketball
- B. Football
- C. Tennis**
- D. Golf



Q. In Golf game what is term used for a short shot intended to play the ball onto the green and as near to the hole as possible?

- A. Drive
- B. Chip
- C. Eagle
- D. Birdie

Q. In Golf game what is term used for a short shot intended to play the ball onto the green and as near to the hole as possible?

A. Drive

B. Chip

C. Eagle

D. Birdie

Q. Which of the following sports and term is not correctly matched?

- A. Golf - Stymie
- B. Archery - Bull's Eye
- C. Swimming - Blue line
- D. Billiards - Hazard

Q. Which of the following sports and term is not correctly matched?

- A. Golf - Stymie
- B. Archery - Bull's Eye
- C. Swimming - Blue line**
- D. Billiards - Hazard



Q. The term Advantage, Halfway Line, and 16 Yard Hit are associated with which of the following sports?

A. Cricket

B. Badminton

C. Golf

D. Hockey

Q. The term Advantage, Halfway Line, and 16 Yard Hit are associated with which of the following sports?

- A. Cricket
- B. Badminton
- C. Golf
- D. Hockey**



Q. Penalty Corner is related to which of the following sports?

- A. Football
- B. Cricket
- C. Hockey
- D. Tennis

Q. Penalty Corner is related to which of the following sports?

- A. Football
- B. Cricket
- C. Hockey**
- D. Tennis



Q. Chinaman, Crease, and Duck are related to which of the following sports?

- A. Football
- B. Cricket
- C. Hockey
- D. Tennis

Q. Chinaman, Crease, and Duck are related to which of the following sports?

- A. Football
- B. Cricket**
- C. Hockey
- D. Tennis



Q. "Showjumping" terminology is associated with which of the following sports?

- A. Football
- B. Hockey
- C. Rugby Football
- D. Horse – Riding

Q. "Showjumping" terminology is associated with which of the following sports?

- A. Football
- B. Hockey
- C. Rugby Football
- D. Horse – Riding**



Q. Chop, Half Volley are related to which of the following sports?

- A. Football
- B. Cricket
- C. Hockey
- D. Table Tennis

Q. Chop, Half Volley are related to which of the following sports?

- A. Football
- B. Cricket
- C. Hockey
- D. Table Tennis



Q. The term 'Sidarm, Penetration' is associated with which sport?

- A. Basketball
- B. Volleyball
- C. Tennis
- D. Golf

Q. The term 'Sidearm, Penetration' is associated with which sport?

- A. Basketball
- B. Volleyball**
- C. Tennis
- D. Golf



Q. The term 'Haymaker, Liver Shot' is associated with which sport?

- A. Boxing
- B. Football
- C. Tennis
- D. Golf

Q. The term 'Haymaker, Liver Shot' is associated with which sport?

- A. Boxing**
- B. Football
- C. Tennis
- D. Golf



Q. In Golf game what is term used for a short shot intended to play the ball onto the green and as near to the hole as possible?

- A. Drive
- B. Chip
- C. Eagle
- D. Birdie

Q. In Golf game what is term used for a short shot intended to play the ball onto the green and as near to the hole as possible?

- A. Drive
- B. Chip**
- C. Eagle
- D. Birdie



Q. The term Crease, Pavilion is associated with which of the following sports?

- A. Cricket
- B. Badminton
- C. Golf
- D. Hockey

Q. The term Crease, Pavilion is associated with which of the following sports?

A. Cricket

B. Badminton

C. Golf

D. Hockey



Q. The term Advantage, Halfway Line, and 16 Yard Hit are associated with which of the following sports?

A. Cricket

B. Badminton

C. Golf

D. Hockey

Q. The term Advantage, Halfway Line, and 16 Yard Hit are associated with which of the following sports?

- A. Cricket
- B. Badminton
- C. Golf
- D. Hockey**



Q. The term “double fault” is used in:

- A. Volleyball
- B. Tennis
- C. Snooker
- D. Kabbadi

Q. The term “double fault” is used in:

- A. Volleyball
- B. Tennis**
- C. Snooker
- D. Kabbadi

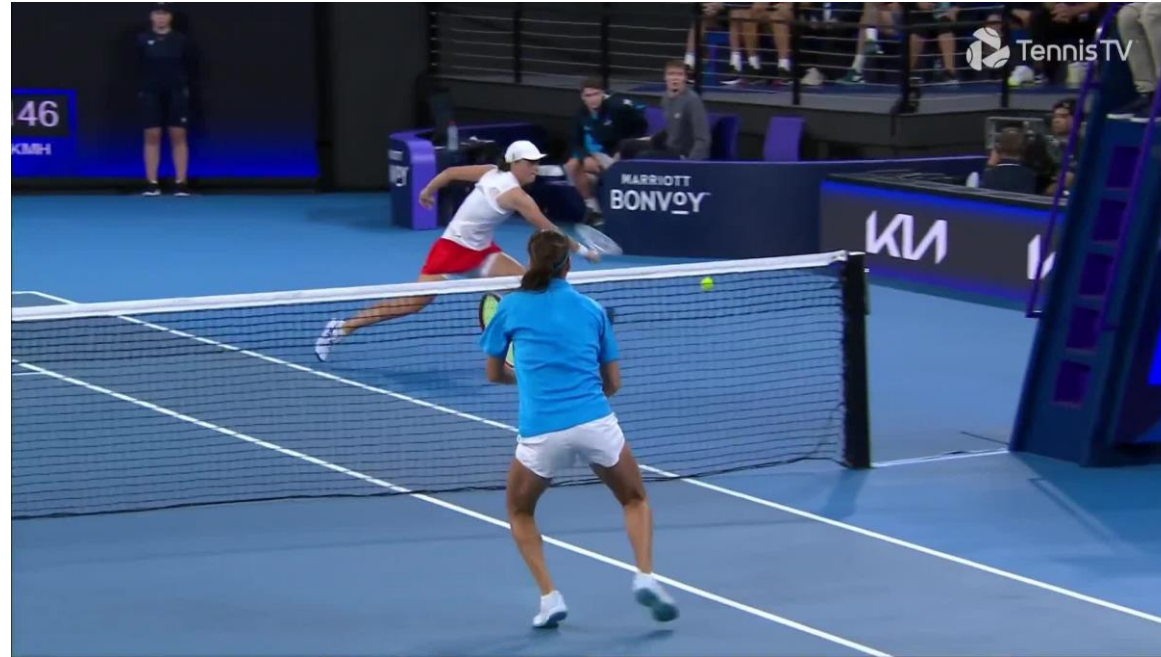

Q. The national game of Bhutan is:

- A. Basketball
- B. Badminton
- C. Football
- D. Archery

Q. The national game of Bhutan is:

- A. Basketball
- B. Badminton
- C. Football
- D. Archery**

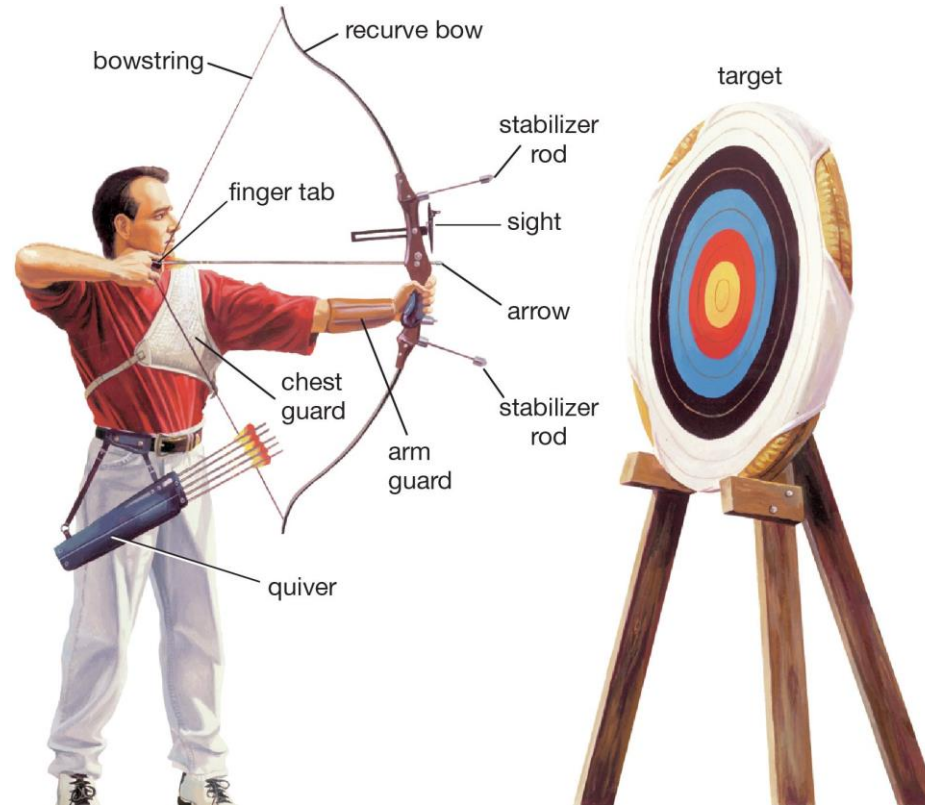

Q. 'Deuce' is a term associated with _____.

- A. baseball
- B. cricket
- C. hockey
- D. lawn tennis

Q. 'Deuce' is a term associated with _____.

- A. baseball
- B. cricket
- C. hockey
- D. lawn tennis**

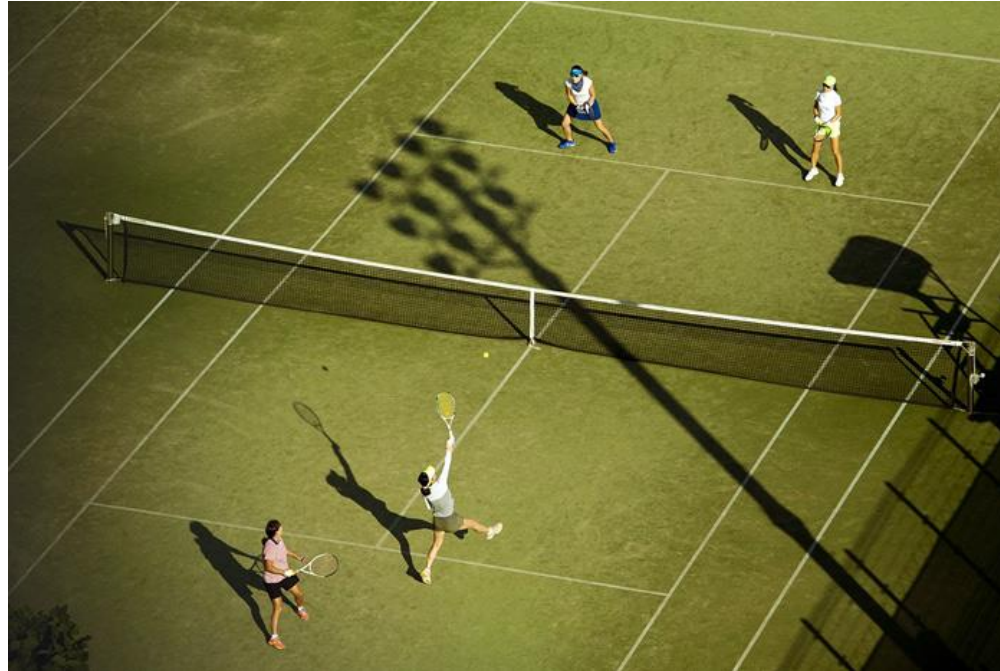

Q. Birdie, eagle and albatross are all terms used in _____.

- A. polo
- B. golf
- C. football
- D. baseball

Q. Birdie, eagle and albatross are all terms used in _____.

- A. polo
- B. golf**
- C. football
- D. baseball



Q. The term ‘Dresses, Showjumping’ is associated with which sport?

- A. Football
- B. Swimming
- C. Cricket
- D. Horse Riding

Q. The term ‘Dresses, Showjumping’ is associated with which sport?

- A. Football
- B. Swimming
- C. Cricket
- D. Horse Riding**



Q. With which game is the word 'Jerk, Snatch' associated?

- A. Weight Lifting
- B. Basketball and Badminton
- C. Cricket and Tennis
- D. Tennis and Badminton

Q. With which game is the word 'Jerk, Snatch' associated?

A. Weight Lifting

B. Basketball and Badminton

C. Cricket and Tennis

D. Tennis and Badminton



Q. The term 'Point Race' is associated with which sport?

- A. Golf
- B. Football
- C. Tennis
- D. Cycling

Q. The term 'Point Race' is associated with which sport?

- A. Golf
- B. Football
- C. Tennis
- D. Cycling**



Q. Double Eagle, All Square are related to which of the following sports?

- A. Football
- B. Cricket
- C. Golf
- D. Tennis

Q. Double Eagle, All Square are related to which of the following sports?

- A. Football
- B. Cricket
- C. Golf**
- D. Tennis



Q. "Showjumping" terminology is associated with which of the following sports?

- A. Football
- B. Hockey
- C. Rugby Football
- D. Horse – Riding

Q. "Showjumping" terminology is associated with which of the following sports?

- A. Football
- B. Hockey
- C. Rugby Football
- D. Horse – Riding**



Q. The term Sit Up, Floor Exercise are associated with which of the following sports?

- A. Cricket
- B. Badminton
- C. Golf
- D. Gymnastics

Q. The term Sit Up, Floor Exercise are associated with which of the following sports?

- A. Cricket
- B. Badminton
- C. Golf
- D. Gymnastics**



Q. Discuss Throw, Shot Put are related to which of the following sports?

- A. Football
- B. Cricket
- C. Hockey
- D. Athletics

Q. Discuss Throw, Shot Put are related to which of the following sports?

- A. Football
- B. Cricket
- C. Hockey
- D. Athletics**



Q. With which game is the word 'Air rifle, Range' associated?

- A. Chess and Cricket
- B. Shooting
- C. Cricket and Tennis
- D. Tennis and Badminton

Q. With which game is the word 'Air rifle, Range' associated?

- A. Chess and Cricket
- B. Shooting**
- C. Cricket and Tennis
- D. Tennis and Badminton



Q. "Throw, & Strike" terminology is associated with which of the following sports?

- A. Football
- B. Hockey
- C. Rugby Football
- D. Baseball

Q. "Throw, & Strike" terminology is associated with which of the following sports?

- A. Football
- B. Hockey
- C. Rugby Football
- D. Baseball**



Q. The term Service Court, Back Hand is related to which of the following games?

- A. Golf
- B. Badminton
- C. Polo
- D. Tennis

Q. The term Service Court, Back Hand is related to which of the following games?

A. Golf

B. Badminton

C. Polo

D. Tennis



Q. The term “Stopper, Defender” are used in:

- A. Volleyball
- B. Tennis
- C. Snooker
- D. Football

Q. The term “Stopper, Defender” are used in:

- A. Volleyball
- B. Tennis
- C. Snooker
- D. Football**



Q. The term 'Personal Fouls' is related to

- A. Volleyball
- B. Cricket
- C. Basketball
- D. Football

Q. The term 'Personal Fouls' is related to

- A. Volleyball
- B. Cricket
- C. Basketball
- D. Football



Q. ‘International Master’ is a term associated with _____.

- A. baseball
- B. cricket
- C. hockey
- D. chess

Q. 'International Master' is a term associated with _____.

- A. baseball
- B. cricket
- C. hockey
- D. chess**



Q. 'Paint, Airball' are terms associated with _____.

- A. baseball
- B. cricket
- C. hockey
- D. basketball

Q. 'Paint, Airball' are terms associated with _____.

- A. baseball
- B. cricket
- C. hockey
- D. basketball**



Q. FreeStyle is the term used in _____.

- A. polo
- B. golf
- C. wrestling
- D. baseball

Q. Free Style is the term used in _____.

- A. polo
- B. golf
- C. **wrestling**
- D. baseball



Q. The term 'Jerk' is associated with which sport?

- A. Weight Lifting
- B. Swimming
- C. Cricket
- D. Tennis

Q. The term 'Jerk' is associated with which sport?

A. Weight Lifting

B. Swimming

C. Cricket

D. Tennis



Q. What is the name of the first indigenous medium-altitude long-endurance (MALE) drone recently acquired by the Indian Navy?

- A. SkyGuardian
- B. Drishti 10 Starliner
- C. Falcon Eye
- D. Aero Hawk

Q. What is the name of the first indigenous medium-altitude long-endurance (MALE) drone recently acquired by the Indian Navy?

A. SkyGuardian

B. Drishti 10 Starliner

C. Falcon Eye

D. Aero Hawk

The Indian Navy has recently acquired the Drishti 10 Starliner unmanned aerial vehicle (UAV), the first indigenous medium-altitude long-endurance (MALE) drone, marking a significant enhancement in intelligence, surveillance, and reconnaissance capabilities.

Q. What has the Indian Army declared 2024 as, emphasizing its commitment to utilizing technology?

- A. Year of Technology Absorption
- B. Year of Modernization
- C. Year of Cybersecurity
- D. Year of Infrastructure Enhancement

Q. What has the Indian Army declared 2024 as, emphasizing its commitment to utilizing technology?

- A. Year of Technology Absorption**
- B. Year of Modernization
- C. Year of Cybersecurity
- D. Year of Infrastructure Enhancement



The Indian Army has declared 2024 as the '**Year of Technology Absorption,**' reflecting its dedication to leveraging technology.

Q. What is the name of the indigenous assault rifle launched by DRDO for the armed forces?

- A. Ugram
- B. Rakshak
- C. Nirbhay
- D. Shakti

Q. What is the name of the indigenous assault rifle launched by DRDO for the armed forces?

- A. Ugram**
- B. Rakshak
- C. Nirbhay
- D. Shakti

DRDO introduced 'Ugram,' an indigenous assault rifle with a 7.62 x 51 mm calibre, meeting robust standards for military-grade rifles. Ugram showcases an effective range of 500 meters, addressing diverse combat scenarios. The first operational prototype was unveiled at the Armament and Combat Engineering Systems of the DRDO in Pune.

Q. In which city did the Defence Ministry sign contracts worth 802 crores for military equipment acquisition?

- A. Mumbai
- B. Kolkata
- C. Bengaluru
- D. New Delhi

Q. In which city did the Defence Ministry sign contracts worth 802 crores for military equipment acquisition?

- A. Mumbai
- B. Kolkata
- C. Bengaluru
- D. New Delhi**

The Defence Ministry signed contracts worth 802 crores for military equipment acquisition in New Delhi, including the procurement of 697 Bogie Open Military Wagons (cost: 473 crores) and 56 Mechanical Minefield Marking Equipment (cost: 329 crores). This emphasizes the Buy Indian category, promoting indigenous manufacturing and private sector participation in defence production.

Q. Where was HAL's Aero Engine Research and Development Centre (AERDC) facility inaugurated?

- A. Bengaluru
- B. Gujarat
- C. Mumbai
- D. Uttar Pradesh

Q. Where was HAL's Aero Engine Research and Development Centre (AERDC) facility inaugurated?

A. Bengaluru

B. Gujarat

C. Mumbai

D. Uttar Pradesh

Defence Secretary Giridhar Aramane inaugurated HAL's Aero Engine R&D Centre in Bengaluru, signifying a commitment to 'Aatmanirbharta' in aero-engine design and development.

Q. Which messaging platform has Para-military forces adopted for secure official communication, document sharing, and prioritizing data security?

- A. Line App
- B. Signal App
- C. WeChat App
- D. Sandes App

Q. Which messaging platform has Para-military forces adopted for secure official communication, document sharing, and prioritizing data security?

- A. Line App
- B. Signal App
- C. WeChat App
- D. Sandes App**

Para-military forces have transitioned to the 'Sandes App,' an open-source messaging platform developed by NIC. The app ensures end-to-end encryption and privacy, serving as a secure communication platform within paramilitary organizations.

Q. Which project category does INS Imphal belong to among the guided missile destroyers?

- A. Project 14
- B. Project 15
- C. Project 16
- D. Project 17

Q. Which project category does INS Imphal belong to among the guided missile destroyers?

A. Project 14

B. Project 15

C. Project 16

D. Project 17

INS Imphal is the third vessel in the 'Project 15 Bravo Vishakhapatnam class' guided missile destroyers, making it part of Project 15.

Q. Which organization has signed a Rs 5,336.25 crore contract with the Ministry of Defence for the 10-year supply of Electronic Fuzes?

- A. Bharat Electronics Limited
- B. Hindustan Aeronautics Limited
- C. Tata Advanced Systems
- D. Defence Research and Development Organisation

Q. Which organization has signed a Rs 5,336.25 crore contract with the Ministry of Defence for the 10-year supply of Electronic Fuzes?

- A. Bharat Electronics Limited**
- B. Hindustan Aeronautics Limited
- C. Tata Advanced Systems
- D. Defence Research and Development Organisation

Bharat Electronics Limited (BEL) from Pune has entered into a significant contract with the Ministry of Defence for the 10-year procurement of Electronic Fuzes, promoting self-reliance in ammunition.

Q. Which ship did the Indian Navy recently re-induct after extensive repairs and upgrades?

- A. INS Arihant
- B. INS Virat
- C. INS Tarmugli
- D. INS Sahyadri

Q. Which ship did the Indian Navy recently re-induct after extensive repairs and upgrades?

- A. INS Arihant
- B. INS Virat
- C. INS Tarmugli**
- D. INS Sahyadri

INS Tarmugli, originally named INS Tillanchang, was recently re-inducted by the Indian Navy after undergoing repairs and upgrades at the Naval Dockyard in Visakhapatnam. The ship had been gifted to the Maldives, renamed MCGS Huravee, and was returned to India after decommissioning in May 2023 due to changing diplomatic relations.

Q. What weapon system does the Indian Defence Ministry's recent approval of Rs 2800 Crore aim to enhance the Indian Army's artillery capabilities?

- A. BrahMos Missile System
- B. Agni Ballistic Missile System
- C. Akash Surface-to-Air Missile System
- D. Pinaka Weapon System

Q. What weapon system does the Indian Defence Ministry's recent approval of Rs 2800 Crore aim to enhance the Indian Army's artillery capabilities?

- A. BrahMos Missile System
- B. Agni Ballistic Missile System
- C. Akash Surface-to-Air Missile System
- D. Pinaka Weapon System**

The Defence Ministry's approval of Rs 2800 Crore is directed towards enhancing the Indian Army's artillery capabilities through the acquisition of rockets for the Pinaka multi-barrel rocket launcher systems.

Q. How many C-295 transport aircraft are set to be acquired collectively by the Indian Coast Guard and Navy for maritime surveillance?

- A. 15
- B. 9
- C. 12
- D. 18

Q. How many C-295 transport aircraft are set to be acquired collectively by the Indian Coast Guard and Navy for maritime surveillance?

A. 15

B. 9

C. 12

D. 18

The Indian Coast Guard and Navy are poised to acquire a total of 15 C-295 transport aircraft for maritime surveillance, with the Navy considering nine planes, and the Indian Coast Guard planning to procure six. This strategic move aims to enhance self-reliance in the defence sector and bolster the country's maritime operations. The C-295 transport aircraft are being manufactured in India through a collaborative effort between Tata Advanced Systems and Airbus.



SSB INTERVIEW MASTERCLASS

JOIN TODAY

- 1 Year Full Access Anytime Anywhere
- 200+ Hours of Live SSB Classes
- Batch Language : Hindi & English
- 3000+ Hours Video Lectures
- Personalised Guidance

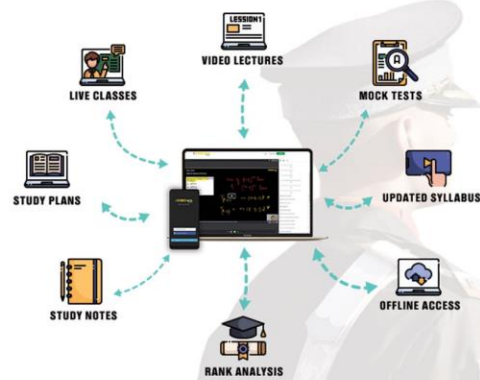

ACCESS NOW



TALK TO OUR DEFENCE MENTORS
CALL US : 08069185400

[STORE](#) / [BUNDLE](#) / [AFCAT EXAM ONLIN...](#)

AFCAT Exam Online Coaching 2024

AFCAT 1 2024: 🎓 Live Classes ▶ In-Depth Lectures 📄 Study Notes 🍷 Mock Tests 📅 Current Affairs ✂ Defence Current Affairs.

★★★★★ 5.0 (147)

Content 19





AFCAT 1 2024 LIVE BATCH AFCAT 1 2024 Live Batch - 2 (Enroll Now)

Course • 140 Lessons 2 Trials



AFCAT 1 2024 LIVE BATCH AFCAT 1 2024 Live Batch - 1

Course • 376 Lessons 1 Trial



AFCAT 2 2023 LIVE BATCH AFCAT 2 2023 Live Batch

Course • 924 Lessons 3 Trials



🕒 365 Days validity

₹ 5,999 ~~₹ 7,999~~ 25% OFF

What's included

📁 19 Courses

Other Pricing Plans

Only for AFCAT 1 2024

180 Days Validity

[Details](#)

₹ 4,999 ~~₹ 5,999~~ 17% off

Choose from our Courses



SSB INTERVIEW
SSB, AFSB & NSB

- Live Classes
- In-Depth Lectures
- SSB Notes
- Mock Tests
- Current Affairs
- Defence Current Affairs

USE CODE: **"WARRIOR10"**
FOR 10% OFF ON SSB COURSE

SSB Interview Online
Coaching 2023 - 2024

19 courses ₹9999 **₹6999**



CDS 1 2024
IMA, AFA & INA

- Live Classes
- In-Depth Lectures
- Study Notes
- Mock Tests
- Current Affairs
- Defence Current Affairs

USE CODE: **"WARRIOR10"**
FOR 10% OFF ON CDS COURSE

CDS Exam Online Coaching
2024

19 courses ₹7999 **₹5999**



NDA 1 2024
National Defence Academy

- Live Classes
- In-Depth Lectures
- Study Notes
- Mock Tests
- Current Affairs
- Defence Current Affairs

USE CODE: **"WARRIOR10"**
FOR 10% OFF ON NDA COURSE

NDA Exam Online Coaching
2024

19 courses ₹7999 **₹5999**



CDS 1 2024
OTA Chennai

- Live Classes
- In-Depth Lectures
- Study Notes
- Mock Tests
- Current Affairs
- Defence Current Affairs

USE CODE: **"WARRIOR10"**
FOR 10% OFF ON CDS COURSE

CDS Exam OTA Online
Coaching 2024

18 courses ₹7499 **₹5499**



AFCAT 1 2024
Air Force Common Admission Test

- Live Classes
- In-Depth Lectures
- Study Notes
- Mock Tests
- Current Affairs
- Defence Current Affairs

USE CODE: **"WARRIOR10"**
FOR 10% OFF ON AFCAT COURSE

AFCAT Exam Online Coaching
2024

18 courses ₹7999 **₹5999**



Territorial Army Exam
Online Coaching 2023

USE CODE: **"WARRIOR10"**
FOR 10% OFF ON TA COURSE

Territorial Army Exam
Online Coaching 2023

17 courses ₹7999 **₹5999**



ACC Exam Coaching 2024

USE CODE: **"WARRIOR10"**
FOR 10% OFF ON ACC COURSE

ACC Exam Coaching 2024

15 courses ₹5999 **₹4999**



UPSC CAPF Assistant
Commandant Online Cours...

UPSC CAPF Assistant
Commandant Online Cours...

27 courses ₹4999 **₹3999**

Daily Current Affairs And Defence Updates 2024

Latest Daily Current Affairs And Defence Updates for preparation of Defence and other competitive Exams like NDA, CDS, AFCAT, TA, GROUP X & Y, INET, ACC, CAPF(AC), MNS, WMP, SCO, PCSL and SSB Interview.

Syllabus

01	Daily Current Affairs And Defence Updates 2024 - January 2024	▼
	10 Lessons	
02	Daily Current Affairs And Defence Updates 2024 - February 2024	▼
	92 Lessons • 45 Attachments	
03	Daily Current Affairs And Defence Updates 2024 - March 2024	▼
	82 Lessons • 41 Attachments	
04	Daily Current Affairs And Defence Updates 2024 - April 2024	▼
	84 Lessons • 42 Attachments	
05	Daily Current Affairs And Defence Updates 2024 - May 2024	▼
	54 Lessons • 27 Attachments	



🕒 90 Days validity

[Change Validity](#)

₹3,999 ~~₹4,999~~ 20% OFF

BUY BUNDLE

START A FREE TRIAL

What's included

+ 676 Lessons

✓ Online Accessibility

India's Most Popular Portal for Defence Exam Preparation

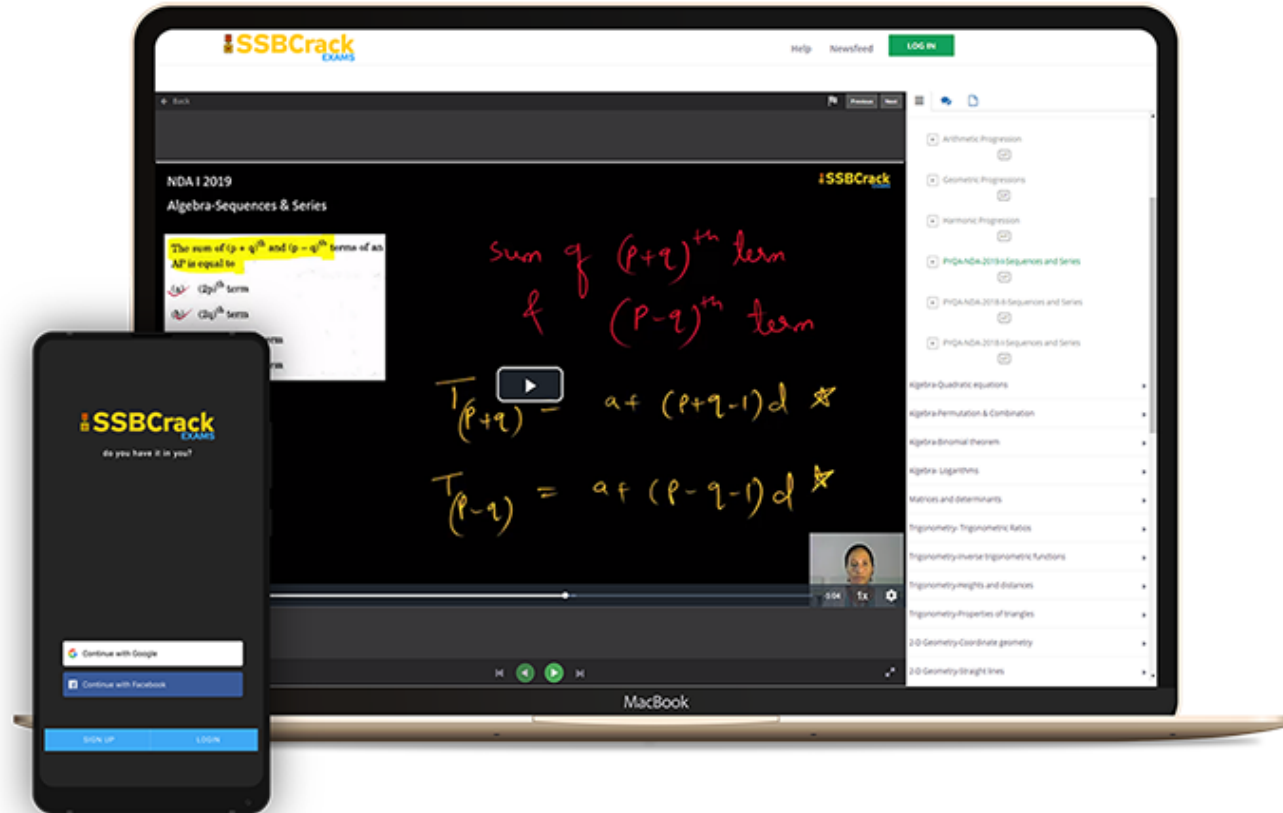

www.ssbcrackexams.com

CODE: WARRIOR10

get an extra **10%** off on all courses





AFCAT 2 2024

MAHA MARATHON #1

COMPLETE REVISION



5TH AUG 2024
1 PM TO 5 PM



LIVE CLASS



AFCAT 2 2024

MAHA MARATHON

05 TO 08 AUG 2024

01 PM TO 02 PM

REASONING - RUBY MA'AM

02 PM TO 03 PM

ENGLISH - ANURADHA MA'AM

03 PM TO 04 PM

STATIC GK - DIVYANSHU SIR

04 PM TO 05 PM

MATHS - NAVJYOTI SIR



CALL US: 080-69185400



DOWNLOAD
THE APP NOW







AFCAT Exam Online Coaching 2024

AFCAT 2024: 📺 Live Classes 🎥 In-Depth Lectures 📄 Study Notes 🚩 Mock Tests 📅 Current Affairs ✂ Defence Current Affairs.

★★★★★ 5.0 (147)

Content 20

Search in bundle 🔍 FILTER BY TYPE ▾

-  AFCAT 2 2024 Live Batch - 1
Course • 221 Lessons 1 Trial
-  AFCAT 1 2024 Live Batch - 2
Course • 148 Lessons 2 Trials
-  AFCAT 1 2024 Live Batch - 1
Course • 376 Lessons 1 Trial
-  AFCAT 2 2023 Live Batch
Course • 924 Lessons 3 Trials



AFCAT
Air Force Common Admission Test

- 📺 Live Classes
- 🎥 In-Depth Lectures
- 📄 Study Notes
- 🚩 Mock Tests
- 📅 Current Affairs
- ✂ Defence Current Affairs.

USE CODE: **"WARRIOR10"**
FOR 10% OFF ON NDA COURSE

🕒 365 Days validity

₹ 5,999 ~~₹ 7,999~~ 25% OFF

BUY BUNDLE

START A FREE TRIAL

What's included

📁 20 Courses

Other Pricing Plans

Only for AFCAT 2 2024

180 Days Validity

🔗 Details

₹ 4,999 ~~₹ 5,999~~ 17% off

BUY NOW

Choose from our Courses



SSB Interview Online Course
2022 - 2023

19 courses ₹9999 **₹6999**



NDA Exam Online Course
2023 - 2024

24 courses ₹7999 **₹5999**



CDS OTA Exam Online Course
2023 - 2024

23 courses ₹7499 **₹5499**



CDS Exam Online Course
2023 - 2024

24 courses ₹7999 **₹5999**



AFCAT Exam Online Course
2023 - 2024

24 courses ₹7999 **₹5999**



Territorial Army Exam
Online Course 2022 -2023

26 courses ₹4999 **₹3999**



ACC Exam Online Course
2023 - 2024

27 courses ₹5999 **₹4999**



MNS Exam Online Course
2023 - 2024

24 courses ₹4999 **₹3999**

[View All](#)

India's Most Popular Portal for Defence Exam Preparation

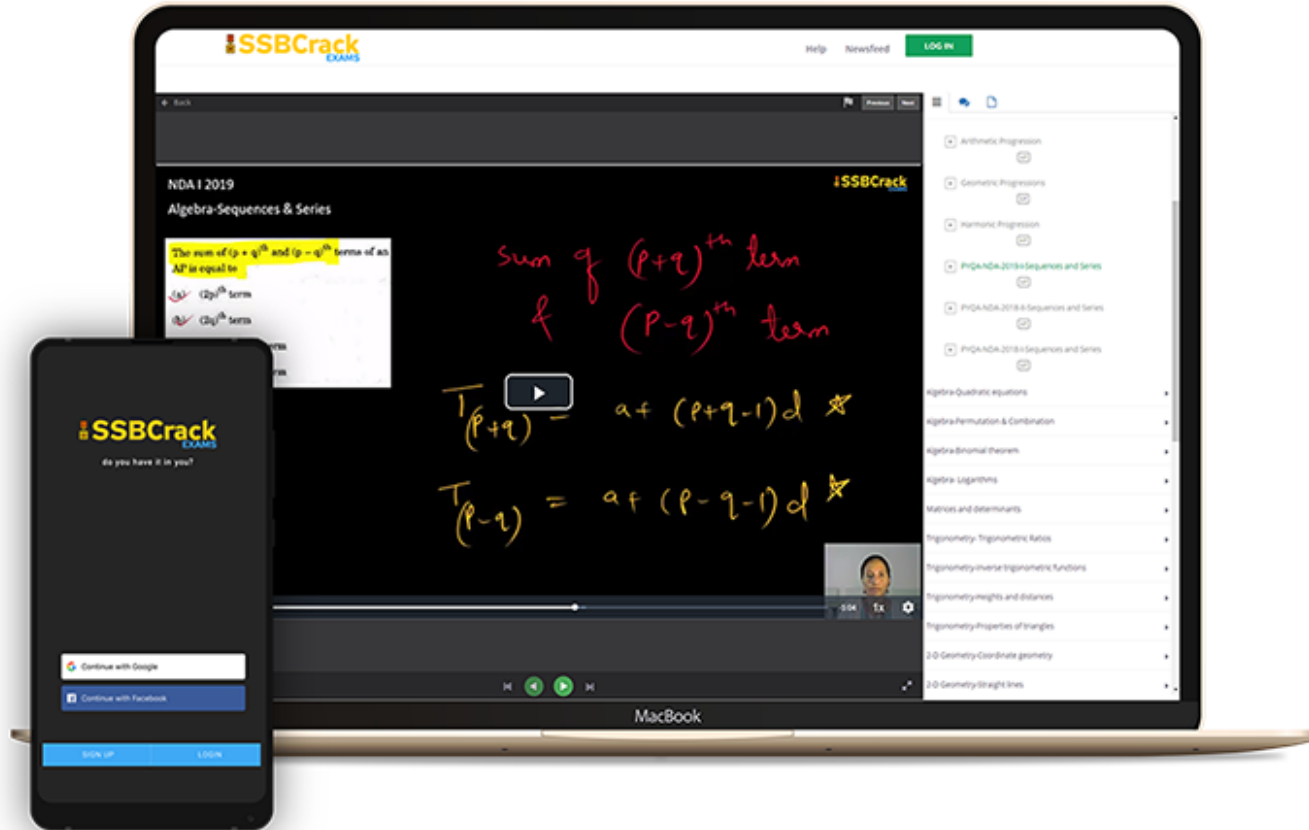

www.ssbcrackexams.com

CODE: WARRIOR10

get an extra 10% off on all courses



Q)The radius of the base of a right circular cone is increased by 15% keeping the height fixed. The volume of the cone will be increased by

- | | |
|------------|------------|
| (a) 30% | (b) 31% |
| (c) 32.25% | (d) 34.75% |

Q)The radius of the base of a right circular cone is increased by 15% keeping the height fixed. The volume of the cone will be increased by

- | | |
|------------|------------|
| (a) 30% | (b) 31% |
| (c) 32.25% | (d) 34.75% |

Ans: (c)

Q) A cloth store is offering buy 3, get 1 free. What is the net percentage discount being offered by the store?

(a) 20%

(b) 25%

(c) 30%

(d) $33\frac{1}{3}\%$

Q) A cloth store is offering buy 3, get 1 free. What is the net percentage discount being offered by the store?

(a) 20%

(b) 25%

(c) 30%

(d) $33\frac{1}{3}\%$

Ans: (b)

Q) In respect of a bill of ₹ 10000, what is the difference between a discount of 40% and two successive discounts of 36% and 4%?

- | | |
|-----------|-----------|
| (a) ₹ 0 | (b) ₹ 144 |
| (c) ₹ 256 | (d) ₹ 400 |

Q) In respect of a bill of ₹ 10000, what is the difference between a discount of 40% and two successive discounts of 36% and 4%?

- | | |
|-----------|-----------|
| (a) ₹ 0 | (b) ₹ 144 |
| (c) ₹ 256 | (d) ₹ 400 |

Ans: (b)

Q) Two articles are sold for ₹9,720 each. On one, the seller gains 8% and on the other, he loses 10%. What is his overall gain or loss?

(a) ₹ 380 gain

(b) ₹ 380 loss

(c) ₹ 360 loss

(d) ₹ 360 gain

Q) Two articles are sold for ₹9,720 each. On one, the seller gains 8% and on the other, he loses 10%. What is his overall gain or loss?

(a) ₹ 380 gain

(b) ₹ 380 loss

(c) ₹ 360 loss

(d) ₹ 360 gain

Ans: (c)

Q) Two vessels are full with milk and water mixed in the ratio 1 : 3 and 3 : 5 respectively. If both are mixed in the ratio 3 : 2, what is the ratio of milk and water in the new mixture ?

(a) 4 : 15

(b) 3 : 7

(c) 6 : 7

(d) None of these

Q) Two vessels are full with milk and water mixed in the ratio 1 : 3 and 3 : 5 respectively. If both are mixed in the ratio 3 : 2, what is the ratio of milk and water in the new mixture ?

(a) 4 : 15
(c) 6 : 7

(b) 3 : 7
(d) None of these

Ans: (b)

Q) A shopkeeper bought 120 quintals of wheat. 20% of it was sold at 25% loss. At what percent gain should he sell the rest to gain 25% on the whole transaction?

- (a) $36\frac{1}{2}$ (b) 40 (c) $37\frac{1}{2}$ (d) 35

Q) A shopkeeper bought 120 quintals of wheat. 20% of it was sold at 25% loss. At what percent gain should he sell the rest to gain 25% on the whole transaction?

- (a) $36\frac{1}{2}$ (b) 40 (c) $37\frac{1}{2}$ (d) 35

Ans: (c)

Q) A is 40% more efficient than B and C is 20% less efficient than B. Working together, they can finish a work in 5 days. In how many days will A alone complete 70% of that work?

- (a) 9 (b) 7 (c) 10 (d) 8

Q) A is 40% more efficient than B and C is 20% less efficient than B. Working together, they can finish a work in 5 days. In how many days will A alone complete 70% of that work?

- (a) 9 (b) 7 (c) 10 (d) 8

Ans: (d)

Q) Pipes A, B and C can fill a tank in 30 h, 40 h and 60 h respectively. Pipes A, B and C are opened at 7 a.m., 8 a.m., and 10 a.m.. respectively on the same day. When will the tank be full?

- | | |
|----------------|----------------|
| (a) 10.00 p.m. | (b) 10.20 p.m. |
| (c) 9.20 p.m. | (d) 9.40 p.m. |

Q) Pipes A, B and C can fill a tank in 30 h, 40 h and 60 h respectively. Pipes A, B and C are opened at 7 a.m., 8 a.m., and 10 a.m.. respectively on the same day. When will the tank be full?

- | | |
|----------------|----------------|
| (a) 10.00 p.m. | (b) 10.20 p.m. |
| (c) 9.20 p.m. | (d) 9.40 p.m. |

Ans: (c)

Q) It takes 11 hours for a 600 km journey if 120 km is done by train and the rest by car. It takes 40 minutes more if 200 km are covered by train and the rest by car. What is the ratio of speed of the car to that of the train?

- (a) 3 : 2 (b) 2 : 3 (c) 3 : 4 (d) 4 : 3

Q) It takes 11 hours for a 600 km journey if 120 km is done by train and the rest by car. It takes 40 minutes more if 200 km are covered by train and the rest by car. What is the ratio of speed of the car to that of the train?

- (a) 3 : 2 (b) 2 : 3 (c) 3 : 4 (d) 4 : 3

Ans: (a)

Q)35 persons are engaged to complete a work in 60 days. After 32 days it is observed that only $(2/5)$ th part of the work has been done. The number of persons to be engaged to complete the remaining work in the said period is

- (a) 20 (b) 35 (c) 30 (d) 25

Q)35 persons are engaged to complete a work in 60 days. After 32 days it is observed that only $(2/5)$ th part of the work has been done. The number of persons to be engaged to complete the remaining work in the said period is

- (a) 20 (b) 35 (c) 30 (d) 25

Ans: (d)

Q) The ratio of investment by A to that by B in a business is 14: 15 and the ratio of their respective profits at the end of a year is 2 : 5. If A invested the money for 3 months, then for how much time (in months) B invested his money?

- (a) 7 (b) 6 (c) 5 (d) 9

Q) The ratio of investment by A to that by B in a business is 14: 15 and the ratio of their respective profits at the end of a year is 2 : 5. If A invested the money for 3 months, then for how much time (in months) B invested his money?

- (a) 7 (b) 6 (c) 5 (d) 9

Ans: (a)

Q) The ratio of the income of A to that of B is 5 : 7. A and B save ₹4,000 and ₹5,000 respectively. If the expenditure of A is equal to $66\frac{2}{3}\%$ of the expenditure of B, then the total income of A and B is:

- | | |
|-------------|-------------|
| (a) ₹25,200 | (b) ₹24,000 |
| (c) ₹26,400 | (d) ₹28,800 |

Q) The ratio of the income of A to that of B is 5 : 7. A and B save ₹4,000 and ₹5,000 respectively. If the expenditure of A is equal to $66\frac{2}{3}\%$ of the expenditure of B, then the total income of A and B is:

- | | |
|-------------|-------------|
| (a) ₹25,200 | (b) ₹24,000 |
| (c) ₹26,400 | (d) ₹28,800 |

Ans: (b)

Q) Three taps A, B and C together can fill a tank in 6 hours. Tap C alone can fill the tank in 12 hours. To fill the tank, when it is empty, all the three taps are started together. After working t hours, tap C is closed and the tank is filled in 8 more hours. What is t equal to ?

- (a) 1
- (b) 2
- (c) 4
- (d) 6

Q) Three taps A, B and C together can fill a tank in 6 hours. Tap C alone can fill the tank in 12 hours. To fill the tank, when it is empty, all the three taps are started together. After working t hours, tap C is closed and the tank is filled in 8 more hours. What is t equal to ?

- (a) 1
- (b) 2
- (c) 4
- (d) 6

Ans: (b)

Q)When the Speed of a train is increased by 20%, it takes 20 minutes less to cover the same distance. What is the time taken to cover the same distance with the original speed ?

- | | |
|-----------------|-----------------|
| (a) 140 minutes | (b) 120 minutes |
| (c) 100 minutes | (d) 80 minutes |

Q)When the Speed of a train is increased by 20%, it takes 20 minutes less to cover the same distance. What is the time taken to cover the same distance with the original speed ?

- | | |
|-----------------|-----------------|
| (a) 140 minutes | (b) 120 minutes |
| (c) 100 minutes | (d) 80 minutes |

Ans: (b)

Q) A runs $1\frac{2}{3}$ times as fast as B . If A gives B a start of 80 m, how far must the winning post from the starting point be so that A and B might reach it at the same time ?

(a) 200 m

(b) 300 m

(c) 270 m

(d) 160 m

Q) A runs $1\frac{2}{3}$ times as fast as B . If A gives B a start of 80 m, how far must the winning post from the starting point be so that A and B might reach it at the same time ?

- (a) 200 m (b) 300 m
(c) 270 m (d) 160 m

Ans: (a)

Q) Ram had ₹ 2 lakh, part of which he lent at 15% per annum and rest at 12% per annum. Yearly interest accrued was ₹ 27600. How much did he lent at 15%?

- | | |
|--------------|--------------|
| (a) ₹ 120000 | (b) ₹ 100000 |
| (c) ₹ 80000 | (d) ₹ 60000 |

Q) Ram had ₹ 2 lakh, part of which he lent at 15% per annum and rest at 12% per annum. Yearly interest accrued was ₹ 27600. How much did he lent at 15%?

- (a) ₹ 120000 (b) ₹ 100000
(c) ₹ 80000 (d) ₹ 60000

Ans: (a)

Q) If the difference between S.I and C.I for 2 years on a sum of money lent at 5% is ₹ 6, then the sum B.

- (a) ₹ 2200 (b) ₹ 2400 (c) ₹ 2600 (d) ₹ 2000

Q) If the difference between S.I and C.I for 2 years on a sum of money lent at 5% is ₹ 6, then the sum B.

- (a) ₹ 2200 (b) ₹ 2400 (c) ₹ 2600 (d) ₹ 2000

Ans: (b)

Q) Three coins are tossed together, then the probability of getting atleast one head is

(a) $\frac{1}{2}$

(b) $\frac{3}{4}$

(c) $\frac{1}{8}$

(d) $\frac{7}{8}$

Q) Three coins are tossed together, then the probability of getting atleast one head is

(a) $\frac{1}{2}$

(b) $\frac{3}{4}$

(c) $\frac{1}{8}$

(d) $\frac{7}{8}$

Ans: (d)

Q) A person borrowed ₹ 7500 at 16% compound interest. How much does he have to pay at the end of 2 years to clear the loan ?

- | | |
|-------------|-------------|
| (a) ₹ 9900 | (b) ₹ 10092 |
| (c) ₹ 11000 | (d) ₹ 11052 |

Q) A person borrowed ₹ 7500 at 16% compound interest. How much does he have to pay at the end of 2 years to clear the loan ?

(a) ₹ 9900

(b) ₹ 10092

(c) ₹ 11000

(d) ₹ 11052

Ans: (b)

Q) The area enclosed between the circumferences of two concentric circles is 16π sq cm and their radii are in the ratio 5 : 3. What is the area of the outer circle?

- | | |
|-------------------|-------------------|
| (a) 9π sq cm | (b) 16π sq cm |
| (c) 25π sq cm | (d) 36π sq cm |

Q)The area enclosed between the circumferences of two concentric circles is 16π sq cm and their radii are in the ratio $5 : 3$. What is the area of the outer circle?

- | | |
|-------------------|-------------------|
| (a) 9π sq cm | (b) 16π sq cm |
| (c) 25π sq cm | (d) 36π sq cm |

Ans: (c)

Q) A rectangular lawn $70\text{ m} \times 30\text{ m}$ has two roads each 5 metres wide, running in the middle of it, one parallel to the length and the other parallel to the breadth. Find the cost of gravelling the road at the rate of ₹ 4 per square metre.

- (a) ₹ 2,000 (b) ₹ 1,800
(c) ₹ 1,900 (d) ₹ 1,700

Q) A rectangular lawn $70\text{ m} \times 30\text{ m}$ has two roads each 5 metres wide, running in the middle of it, one parallel to the length and the other parallel to the breadth. Find the cost of gravelling the road at the rate of ₹ 4 per square metre.

- (a) ₹ 2,000 (b) ₹ 1,800
(c) ₹ 1,900 (d) ₹ 1,700

Ans: (c)

Q) The area of a square inscribed in a circle of radius 8 cm is

(a) 32 sq cm

(c) 128 sq cm

(b) 64 sq cm

(d) 256 sq cm

Q) The area of a square inscribed in a circle of radius 8 cm is

(a) 32 sq cm

(b) 64 sq cm

(c) 128 sq cm

(d) 256 sq cm

Ans: (c)

Q) From a pack of 52 cards two cards are drawn in succession one by one without replacement. The probability that both are aces is

(a) $\frac{2}{13}$

(b) $\frac{1}{51}$

(c) $\frac{1}{221}$

(d) $\frac{2}{21}$

Q) A, B and C can complete a work in x , $1.5x$ and $2x$ days respectively. If they complete the work together, in what ratio should they be paid ?

- (a) 2 : 3 : 4
- (b) 6 : 4 : 3
- (c) 3 : 2 : 1
- (d) 4 : 3 : 2

Q) A, B and C can complete a work in x , $1.5x$ and $2x$ days respectively. If they complete the work together, in what ratio should they be paid ?

- (a) 2 : 3 : 4
- (b) 6 : 4 : 3
- (c) 3 : 2 : 1
- (d) 4 : 3 : 2

Ans: (b)

Q)An aeroplane flies along the four sides of a square at a speed of 100, 200, 300 and 400 km/h, respectively. What is the average speed of the plane in its flight around the square?

- (a) 196 km/h (b) 200 km/h
(c) 250 km/h (d) None of these

Q)An aeroplane flies along the four sides of a square at a speed of 100, 200, 300 and 400 km/h, respectively. What is the average speed of the plane in its flight around the square?

- (a) 196 km/h (b) 200 km/h
(c) 250 km/h (d) None of these

Ans: (d)

Q) If the average of 9 consecutive positive integers is 55, then what is the largest integer?

(a) 57

(b) 58

(c) 59

(d) 60

Q) If the average of 9 consecutive positive integers is 55, then what is the largest integer?

- (a) 57 (b) 58 (c) 59 (d) 60

Ans: (c)

Q) If the number 413283P759387 is divisible by 13, then what is the value of P ?

- (a) 3 (b) 6 (c) 7 (d) 8

Q) If the number 413283P759387 is divisible by 13, then what is the value of P ?

- (a) 3 (b) 6 (c) 7 (d) 8

Ans: (d)

Q) Three runners are running in a circular track, and they complete one round in 20, 30 and 35 minutes respectively. when will they next meet at the starting point?

- (a) After 3 hour 30 minutes
- (b) After 4 hour 30 minutes
- (c) After 3 hour
- (d) After 7 hour

- Q) Three runners are running in a circular track, and they complete one round in 20, 30 and 35 minutes respectively. when will they next meet at the starting point?
- (a) After 3 hour 30 minutes
 - (b) After 4 hour 30 minutes
 - (c) After 3 hour
 - (d) After 7 hour

Ans: (d)

Q) What is the remainder after dividing the number 37^{1000} by 9?

(a) 1

(b) 3

(c) 7

(d) 9

Q) What is the remainder after dividing the number 37^{1000} by 9?

(a) 1

(b) 3

(c) 7

(d) 9

Ans: (a)

SSB Interview Online Course

★★★★★ 4.9 (28)

Start your SSB Interview preparation today with SSB Crack Exams.

Content 17 (ALL)

Search in bundle

01		COURSE SSB Interview Live Classes	129 LESSONS
02		COURSE Basics of SSB Interview	68 LESSONS
03		COURSE OIR Test - Verbal Reasoning - Part 1	618 LESSONS
04		COURSE OIR Test - Verbal Reasoning - Part 2	401 LESSONS
05		COURSE OIR Test - Non Verbal Reasoning	455 LESSONS
06		COURSE OIR Test - Practice Sets	20 LESSONS

07		COURSE PPDT (Picture Perception & Description Test)	166 LESSONS
08		COURSE Psychological Tests	195 LESSONS
09		COURSE SSB Personal Interview	74 LESSONS
10		COURSE GTO	104 LESSONS
11		COURSE Conference	6 LESSONS
12		COURSE Medical	12 LESSONS
13		COURSE Personality Development and Motivation	151 LESSONS



What's included

17 Courses

30 Days validity [CHANGE](#)

₹ 6,999.00 20% OFF

[BUY BUNDLE](#)

[ENROLL FOR TRIAL](#)





AFCAT Exam Online Coaching 2024

AFCAT 2024: 🎓 Live Classes ▶ In-Depth Lectures 📄 Study Notes 🚩 Mock Tests 📅 Current Affairs ✂ Defence Current Affairs.

★★★★★ 5.0 (147)

Content 20

🔍 FILTER BY TYPE ▾

-  AFCAT 2 2024 Live Batch - 1
Course • 221 Lessons 1 Trial
-  AFCAT 1 2024 Live Batch - 2
Course • 148 Lessons 2 Trials
-  AFCAT 1 2024 Live Batch - 1
Course • 376 Lessons 1 Trial
-  AFCAT 2 2023 Live Batch
Course • 924 Lessons 3 Trials



AFCAT
Air Force Common Admission Test

- 🎓 Live Classes
- ▶ In-Depth Lectures
- 📄 Study Notes
- 🚩 Mock Tests
- 📅 Current Affairs
- ✂ Defence Current Affairs.

USE CODE: **"WARRIOR10"**
FOR 10% OFF ON NDA COURSE

🕒 365 Days validity

₹ 5,999 ~~₹ 7,999~~ 25% OFF

[BUY BUNDLE](#)

[START A FREE TRIAL](#)

What's included

📁 20 Courses

Other Pricing Plans

Only for AFCAT 2 2024

180 Days Validity

[Details](#)

₹ 4,999 ~~₹ 5,999~~ 17% off

[BUY NOW](#)

Choose from our Courses



SSB INTERVIEW
ONLINE COURSE

USE CODE: "WARRIOR10"
FOR 10% OFF ON SSB COURSE

SSB Interview Online Course
2022 - 2023

19 courses ₹9999 **₹6999**



USE CODE: "WARRIOR10"
FOR 10% OFF ON NDA COURSE

NDA Exam Online Course
2023 - 2024

24 courses ₹7999 **₹5999**



USE CODE: "WARRIOR10"
FOR 10% OFF ON OTA COURSE

CDS OTA Exam Online Course
2023 - 2024

23 courses ₹7499 **₹5499**

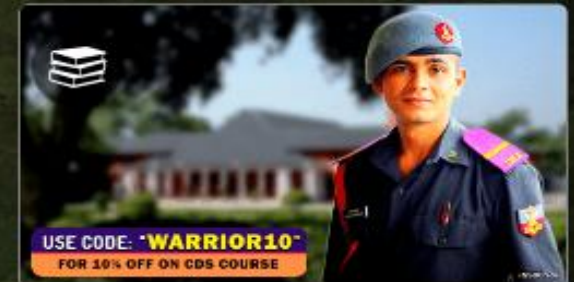

USE CODE: "WARRIOR10"
FOR 10% OFF ON CDS COURSE

CDS Exam Online Course
2023 - 2024

24 courses ₹7999 **₹5999**



USE CODE: "WARRIOR10"
FOR 10% OFF ON AFCAT COURSE

AFCAT Exam Online Course
2023 - 2024

24 courses ₹7999 **₹5999**



USE CODE: "WARRIOR10"
FOR 10% OFF ON TA COURSE

Territorial Army Exam
Online Course 2022 -2023

26 courses ₹4999 **₹3999**



USE CODE: "WARRIOR10"
FOR 10% OFF ON ACC COURSE

ACC Exam Online Course
2023 - 2024

27 courses ₹5999 **₹4999**



USE CODE: "WARRIOR10"
FOR 10% OFF ON MNS COURSE

MNS Exam Online Course
2023 - 2024

24 courses ₹4999 **₹3999**

[View All](#)

India's Most Popular Portal for Defence Exam Preparation

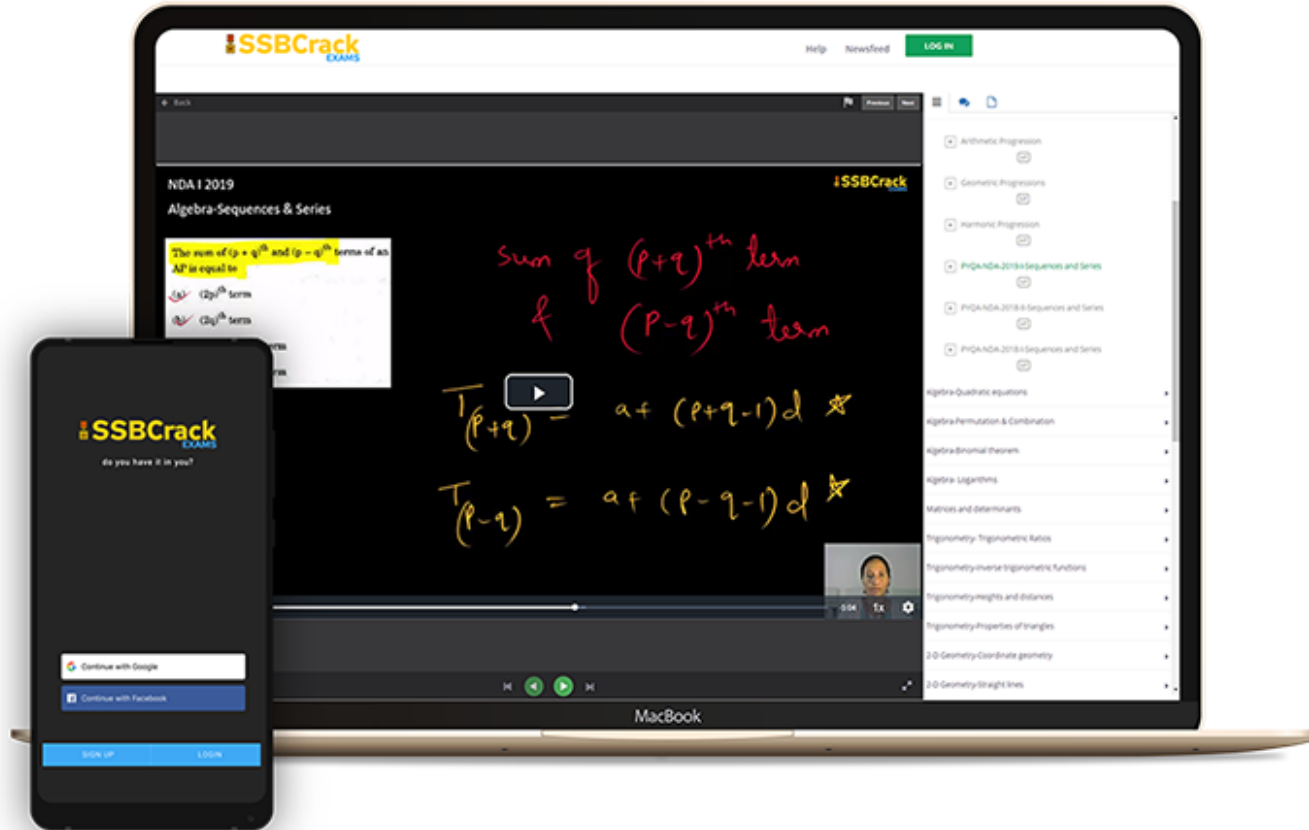

www.ssbcrackexams.com

CODE: WARRIOR10

get an extra 10% off on all courses

